



PROMATECT® 100 Passive Fire Protection Building & Construction Solutions



www.promat.com.au

Solely for distribution in Australia

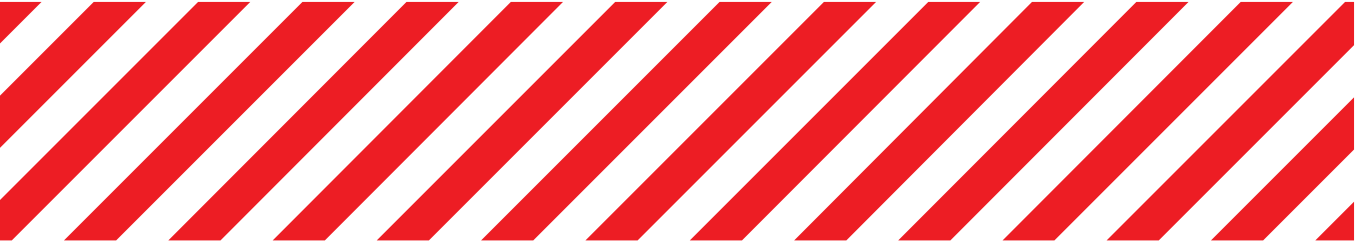

General

Introduction	6
Principles.....	11
About PROMATECT® 100 PROMAXON® mineral board	14
Safety data sheet (SDS).....	16
Loading/uploading, storage and handling of boards	21
Cutting.....	22
Fixing and fabrication.....	24
Flush jointing.....	27
Finishing.....	28

Structural steel fire protection

Structural steel fire protection general information	30
Calculation of section factor (Hp/A)	33
Guide of section factor (Hp/A) for encasement.....	35

Structural steel protection

Structural steel column cladding, FRL 150/-/.....	49
Structural steel beam cladding, FRL 150/-/.....	50
Structural steel column & beam architectural specifications.....	52

Partitions

Partitions system index.....	56
Partitions general information.....	57
Steel frame components.....	59
Timber frame components	62
Acoustic design.....	64
General installation details	
Wall junctions	67
Deflection head.....	68
Base details & movement joints.....	71
Window & door framings.....	72
Load factors	73
Wet area installation details.....	74
Penetration seals and access hatches.....	78
Other details.....	79

Partition systems

Single steel stud partition (double sided), FRL -/90/60	80
Single steel stud partition (double sided), FRL -/120/120.....	81
Single steel stud partition (double sided), FRL -/240/240	87
Single steel stud partition (double sided) architectural specification	93
Double steel stud partition (double sided), FRL -/120/120.....	95
Double steel stud partition (double sided) architectural specification	97
Timber stud partition, FRL -/120/120 & 120/120/120.....	99
Timber stud partition architectural specification	102
Solid/frameless internal partition, FRL -/120/120	103
Solid/frameless internal partition architectural specification	105

Ceilings and floors

Ceilings & floors system index	108
Ceilings & floors general information	110
Steel frame components	113
General installation details	
Perimeter details	115
Control joints details	116
Access hatch	117

Ceiling systems

Self-supporting membrane ceiling (fire attack from above), FRL -/120/120	118
Self-supporting membrane ceiling (fire attack from below), FRL -/120/120	119
Self-supporting membrane ceiling (fire attack from above and below), FRL -/120/120	120
Self-supporting membrane ceiling (fire attack from above and below), FRL -/240/240	121
Self-supporting membrane ceiling architectural specification	122
Timber floor protection, FRL 60/60/60	124
Timber floor protection, FRL 90/90/90 type 1	125
Timber floor protection, FRL 90/90/90 type 2	126
Timber floor protection, FRL 120/120/120	127
Timber floor protection architectural specification	128
Mezzanine floor, FRL 60/60/60	129
Mezzanine floor, FRL 120/120/120	130
Mezzanine floor architectural specification	131

FAQ's and Promat systems in Australia

FAQ's and Promat Systems in Australia	134
---	-----



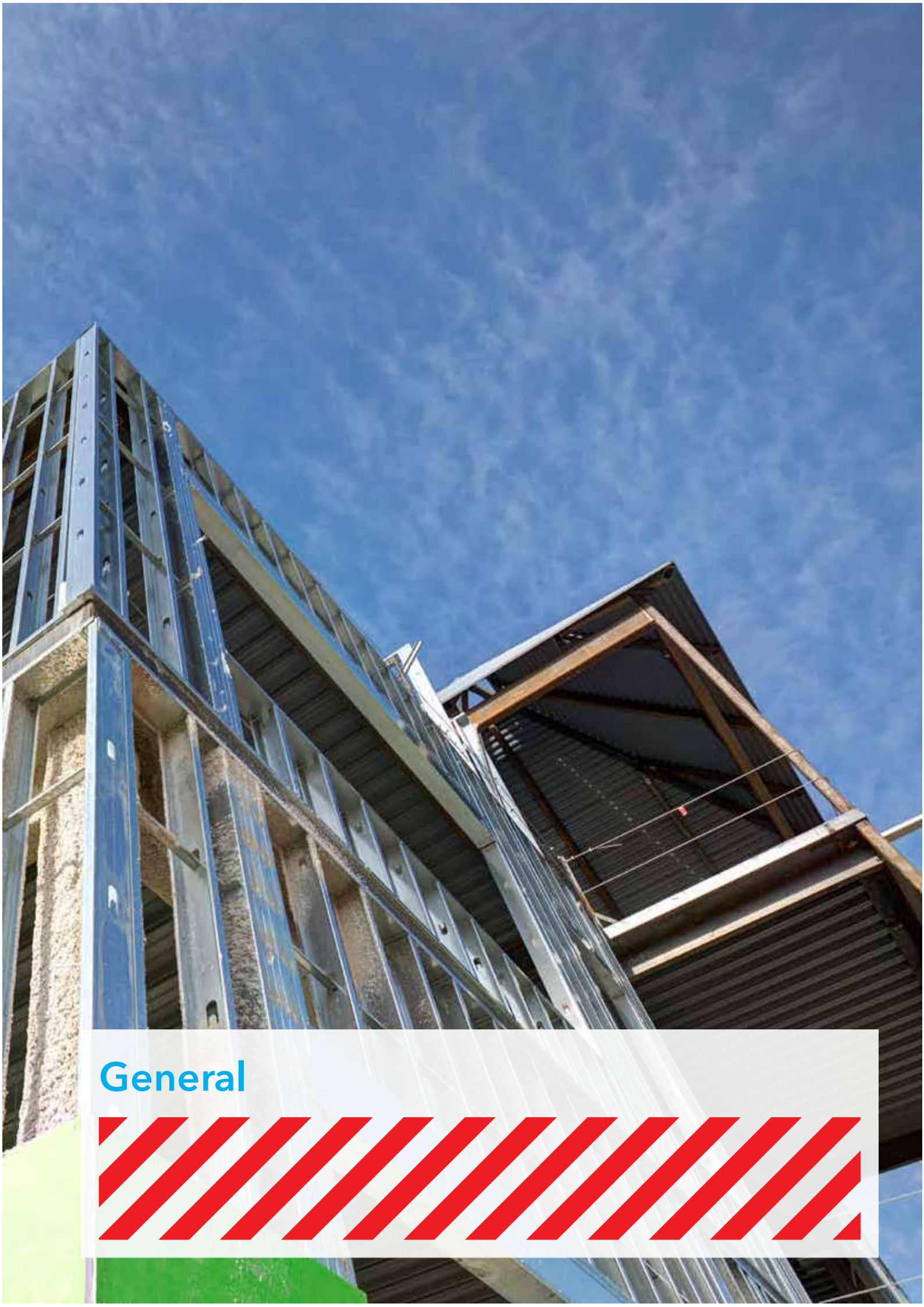

General





The long term effects of global warming and climate change are without doubt the most important issues confronting the world today. The way ahead, however, is clouded with uncertainty. There are those who believe Planet Earth has gone past its “tipping point”, where man’s constant demands for resources and space mean we have lost the natural ability to self-correct, replace and renew.

Others think that the weather extremes we now see before our very eyes on an almost daily basis is part of a natural cycle of events simply repeating itself and will in time lead naturally to a more balanced and sustainable ecological order. Still others believe that the continued application of science and technology will sooner rather than later provide all the appropriate solutions for balanced sustainability. In the meantime, the lack of integrated geopolitical consensus undermines most but not all good intentions and initiatives.

While it is clear that strategies like using less plastic shopping bags at the supermarket and more recycled paper in the workplace are increasingly important, it is also obvious that the 3Rs – Reduce, Recycle and Re-use – are simply no longer enough.

What is required is a coordinated global plan between and acceptable to all stakeholders – government, the private sector, communities and individuals – that capitalises abundant global goodwill and all available resources. While the politicians continue to debate, it is up to a collective of enlightened businesses, non governmental organisations and concerned individuals to lead the way.

Redefining sustainability

The heart of every responsible business today is sustainability and this basically means being profitable in a way that guarantees a future for employees, customers, society and the business itself. We not only have to make responsible products and systems but ensure that they are installed and used in a responsible way.

This requires enlightened policies that look not only at the way business is done but why, when and how, and the impact the business has both upstream and downstream. Doing whatever is necessary to meet bottomline targets is no longer adequate justification. Businesses now have to take a close look at, adopt and respond to wide range of corporate social responsibility factors that customers, communities and regulatory agencies demand.

In the ongoing rush to modernise and prosper, we tend to forget that Mother Nature has always and will continue to hold the key to how man lives, works and survives. For most societies now, lifestyles and expectations have to be adjusted to the realities of true sustainability. We will probably have to make do with less. We will certainly need to be much more efficient in the utilisation of increasingly rare resources.

The process of change and the built environment

Just as weather patterns continue to change, so too do the structures we build and use. As the late British statesman Sir Winston Churchill once astutely observed, “first we shape buildings, thereafter they shape us”.

Continued on opposite page



Indeed, most structures today continue to be designed and built with essentially Victorian technologies, systems and ideas, and mostly inert materials. Ultimately, this is not sustainable. The only way to build genuinely sustainable cities and homes is to connect them to rather than insulate them from nature, as we do now. The best way forward, according to New Wave architects and engineers, is to utilise metabolic or living systems. Research into these new age materials is in the explorative phase at this point in time and so the built environment will remain at least for the foreseeable future mostly a matter of traditional brick and mortar, glass and steel solutions all too susceptible to the unwanted forces and impact of fire.

Nevertheless, the buildings designed and used today are noticeably different from just two, or even one decade ago. And this is not just a matter of architectural and engineering style but also function, and what the building is expected to do for its users and its surrounding communities. Materials are also changing. It is very likely that the built environment of the future will be unrecognisable from what it is today.

One factor is however certain, the bigger and more complex the built environment becomes, the more difficult it is to protect against all forms of threat, particularly fire.

Modern risk management and fire prevention strategies

The level of risk the modern built environment is exposed to nowadays is unimaginable compared to even a decade ago. Terrorism, for example, is a very real threat and one that has quickly become an integral component of virtually every risk management strategy.

At the end of the day however, the danger of unexpected and uncontrolled fire is still the number one threat to buildings and one that continues regrettably to cause thousands of mostly avoidable fatalities each and every year. It is difficult at best to accurately assess total monetary losses of expensive property.

While a bucket of sand in the right hands at the right time and place is still a valid concept, the scale and complexity of the modern built environment demands an expanded approach that integrates numerous scientific methodologies to effectively meet a multiplicity of threats. This means integrating an arsenal of active and passive, cutting edge technologies aimed not just at minimising the occurrence of fire but inhibiting and containing it as effectively as possible, if and when it does occur.

Fortunately, building owners, developers, planners and designers have easy access to a large resource bank of scientific data and empirical evidence to help them make better informed decisions that meet legislative, regulatory and societal expectations in fire safety design.

Huge advances in fire science technology have been made in recent years and the evolution of brilliant, innovative materials for eventual fire safety application are steadily decreasing in cost and becoming increasingly available to more building developers and designers. Companies like Promat – a global leader in the fire sciences industry – are a very good example of this trend. The company's continuing Research & Development programme, and its evolution of new products and systems, keep Promat business profitably at the top of recognised international success.



Environmental, Health and Safety (EHS) policies

As a significant passive fire protection unit of the Etex Group, Promat companies not just offer a support structure of knowledge, production and research and development but an in-depth commitment to consistently articulate well-defined EHS policies as effective benchmarks for sustainable business development.

Going green, a burning issue for the times?

Despite being surrounded by the steel, concrete and glass of crowded, modern urbanity, Promat is profoundly aware that Mother Nature will always hold the key to a successful and sustainable built environment, an undeniable fact of life often overlooked in cities dominated by personal, climate-controlled space. Recycling plastic bags and using less fossil fuels for example, is praiseworthy but no longer enough. It is obvious that society must do much more for the environment, both directly and indirectly.

The policies of Etex Group and its Promat companies are based on a sound value system of corporate social responsibility. The group's very own EHS department is dedicated solely to environmental, health and safety issues of our factories and offices, our people and the communities in which we work.

In the Asia Pacific region, environmental awareness varies, reflecting contrasts in the different stages of socioeconomic development and maturity. Environmental issues are clearly on the agenda and destined to generate more significance in the years ahead.

A good example, for instance, is the support, adherence to and respect for environmental issues highlighted by the Green Building Council of Australia. The Singapore Building and

Construction Authority's Green Building Structure programme is another good strategy for encouraging green building design. Similar green principles are core Promat corporate beliefs.

In other Asia Pacific areas, plans are well underway to ensure that all future buildings will address and resolve numerous environmental concerns.

Sensible and pragmatic Environment Management Systems are tools for the effective management of the impact of a building's footprint and an organisation's activities on the environment. Certified to the international standard ISO 14001, Promat Asia Pacific organisation aims to achieve environmental gains through the implementation of effective environmental management. Adherence to this standard ensures environmental issues are integral components of routine decision-making practices.

Promat's EHS policy is a long term commitment to the future

Promat remains alert and mindful of the fact that the future is sure to demand much more of us in environmental initiatives. There will certainly be daunting challenges ahead, requiring constant adaption, as in the past.

The company's new production lines in factories across the world are very reassuring. There's very little waste and considerable attention given to energy saving. Clearly, environmental responsibility and good business are not mutually exclusive, particularly if the accumulated experience and considerable resources available to Promat are used wisely.



As a global leader in the business of the proactive fire protection, Promat fittingly also takes a proactive approach to environmental, health and safety issues.

Starting in 2005, Promat Asia Pacific organisation implemented its own Environment, Health & Safety policy, entitled "Promat - Towards Sustainable Growth". In doing so, the organisation is committed to:

- the creation of a safe working environment for all its employees and the societies in which the company works,
- control and minimise possible negative impact on the environment,
- include EHS concerns in the development of its products and systems,
- continuous improvement of its EHS performance,
- transparency and open dialogue based on facts and figures with all its stakeholders, and
- the principle that EHS Due Diligence shall be used as standard practice for Mergers and Acquisitions, Investments and Divestments.

The policy applies to all Promat entities and necessary resources are allocated to enable correct implementation of its EHS policy.

Before making critical investment or acquisition decisions, the environmental, health and safety aspect is systematically evaluated.

Accordingly, Promat has developed a checklist which enables the organisation to form an accurate overview of the relevant EHS aspects in a relatively short space of time.

Environmental policies are a continuing and evolutionary progress

It should always be noted that – to be relevant, meaningful and accurate – realistic environmental policies must continually evolve...after all, the world around us is constantly changing, too.

A good reflection of this point of view are the recent additions to the Etex Group's EHS policies.

These take a broad view of pertinent ecological issues, along a time line from 2008 and 2011, while looking at specific considerations, which include:

- Occupational Health & Safety Assessment Series (OHSAS) Certification*
- Environmental reporting
- Accident analysis

*The Etex Group and Promat companies are rightly concerned with all matters related to ISO 14001 certification, the universally recognised principles for most environmental management matters. Now, however, the group insists that all group factories comply with OHSAS certification. Implementation is expected to be completed before 2010. Although not an international standard, OHSAS Certification attracts increasing recognition around the world. It is formulated and implemented on a framework of corporate occupational health and safety policies, planning, implementation and operations, checking and corrective action, management reviews and continual improvement.

Research and development drives growth of sophisticated fire protection technologies

Fire protection nowadays is divided into two broad categories. These are described as "active" and "passive" systems.

Active fire protection measures are those that use an integrated system consisting of sprinklers and alarms that require electricity and water to realise their full potential in fire situations.

On the other hand, passive fire protection systems do not require power or water to operate in the event of a fire. They are designed and built into the structure to protect on demand, as and when necessary.

It is the research and development of passive fire protection that Promat has devoted many years and considerable resources. Today, Promat is long recognised worldwide as a leading provider of passive fire protection systems, a reputation reinforced by more than six decades of cutting edge research and development.

Promat run continual investigation programmes at the PRTC facilities in Belgium. The PRTC testing laboratories are accredited to EN 45001. The PRTC furnaces are state-of-the-art and offer multiple possibilities for the testing of construction systems under development. Promat also has R&D facilities in Australia and Malaysia which are used extensively to ensure all Promat systems are suited to the Asia Pacific markets.

All Promat materials are manufactured in accordance with accredited EN ISO 9001:2000 and ISO 14001 quality and environmental management systems. Comprehensive testing of all Promat products and systems has been carried out by independent and nationally approved laboratories around the world in order to meet the relevant sections of BS 476, AS 1530, EN and ISO etc, as well as many other international test standards.

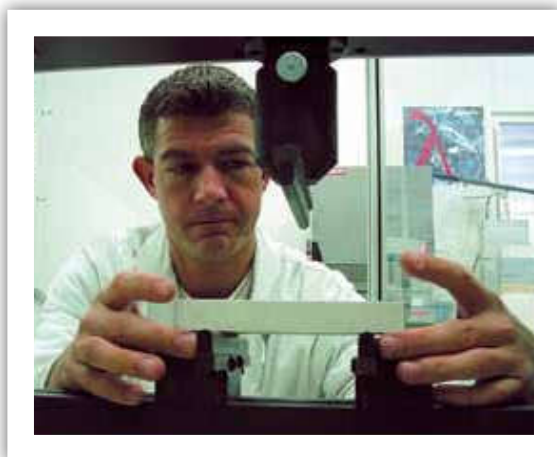

The accumulated knowledge and technical expertise is available to all clients and customers who specify Promat proactive fire protection. Full technical and sales support teams are available to provide information and assistance to help in the design and installation of all Promat fire protection solutions.

Defining modern era passive fire protection

An active fire protection system reacts to conditions caused by a fire such as heat, smoke or light and then tries to control the blaze. This is usually done either by drenching via a sprinkler system, by creating a warning via a smoke alarm, or by activating a fire defence system such as a fire curtain.

Active fire protection is undoubtedly very effective, but has the inherent disadvantage of being dependent upon each of the various elements of the chosen system working, as and when they should. Any vandalism of the water feed mechanism, damage to the operating valves, or simply ignorance, can render the system inoperative. It would be unwise, therefore, to construct a building's fire defence around a single system that cannot always be guaranteed.

A passive fire protection system on the other hand, insulates a structure and prevents the building from collapsing or prevents a fire from spreading beyond the compartment of origin when subjected to the effects of fire. Such protection can buy significant time for the building occupants or users to escape.

It is also the time in which fire fighting services can arrive at the scene, safely enter and remain in the building in order to contain and extinguish the conflagration.

Many passive fire protection materials also give added benefits such as thermal and acoustic insulation. However, to optimise fire protection, active and passive systems must be seen as complementary, not competitive. Legislation frequently recognises this by allowing them to work in tandem. For example, if sprinklers are employed, a reduced degree of passive protection can sometimes be allowed.



Not all blazes are the same, defining types of fire

The fire resistance performance of a specimen of an element of building construction varies. It depends on the ability of the system to withstand exposure to defined heating and pressure conditions. The defined heating condition refers to recognised temperature/time fire curves (**Figure 1**).

Fire curves are the simplest hypothesis accurately representing a fire by predefined temperature and time relationships. Fire curves have evolved historically for fire resistance furnace tests of building materials and elements of construction for classification and verification.

Fire curves recognised by national and international standards organisations are as follows:

1 Standard Cellulosic Time-Temperature Curve

This fire curve covers the basic scenario of a fire of general combustible items of building content and materials of construction. It is based on ISO parameters and is used with – in some cases minor modifications – in test standards throughout the world, including AS 1530: Part 4, ASTM E119, BS 476: Part 20, BS EN 1363: Part 1, DIN 4102: Part 2 and ISO 834: Part 1. It is a model of a ventilated controlled natural fire of general building materials and contents.

2 Hydrocarbon Curve

This curve is a simulation of a ventilated oil fire with a rapid temperature increase. The curve represents combustible hydrocarbons and is applicable where petroleum fires might occur, i.e. petrol or oil tanks, certain chemical facilities etc. In fact, although the hydrocarbon curve is based on a standardised type fire, there are numerous types of fire associated with petrochemical fuels which have wide variations in the duration of the fire, ranging from seconds to days. Please consult Promat for further information.

3 Modified Hydrocarbon (HCM) Curve

As a result of French tunnel regulations for an enhanced version of the Hydrocarbon Curve, the maximum temperature of HCM is 1300°C, instead of the 1080°C benchmark of Standard Hydrocarbon Curve. However, the temperature gradient in the first few minutes of HCM fire is as severe as all other hydrocarbon based fires (e.g. RWS, HC), possibly causing thermal shock to the surrounding concrete structure and concrete spalling is a likely result.

4 RABT Curve

Developed in Germany as an outcome of a series of large scale test programmes such as the Eureka project. In the RABT curve (Richtlinien für die Ausstattung und den Betrieb von Straßentunneln or “Guideline for equipment and operation of road tunnels”), temperature rise is very rapid up to 1200°C, typically within 5 minutes. Duration of the 1200°C exposure is shorter than other curves with the temperature drop off starting to occur at 30 or 60 minutes.

5 RWS Curve

The curve was developed by Rijkswaterstaat (RWS), the Ministry of Transport in Netherlands. This model of a petroleum based fire of 300MW load fire in an enclosed space such as a tunnel, is often specified and internationally accepted for use in tunnels. Temperature increase is 1200°C at 5 minutes and after 30 minutes is 1300°C.

6 External Fire Exposure Curve

This model is for fire exposure external to a building and open to the atmosphere, where there are additional avenues for heat dissipation. There is a lower level of heat exposure, and the temperature increase is approximately 680°C after 20 minutes and remains constant throughout.

7 Slow Heating Curve

This curve simulates a slow growing fire. It is basically a combination of two curves, one for the first 21 minutes representing the smouldering effect of materials and one for subsequent periods representing the growth of the fire towards flashover.

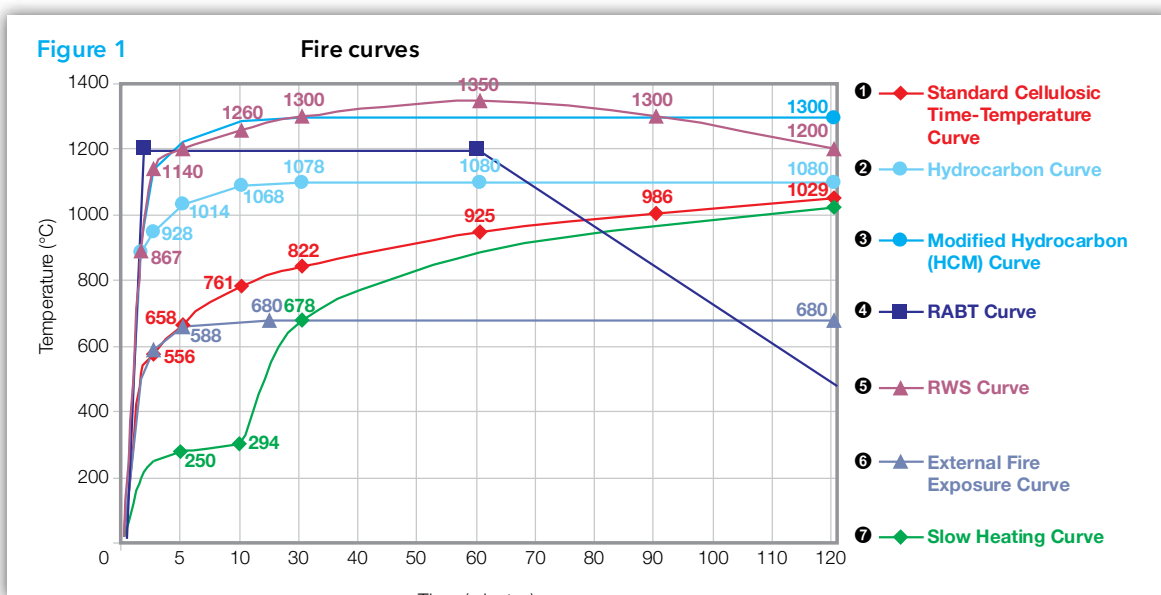

Fire resistance test standards – fire reaction in testing of materials and products

This category provides details of anticipated extent to which materials or products burn and contribute to the development of fire.

AS 1530: Part 1: 1994

“Combustibility tests for materials”

This describes a classification of materials as either non combustible or combustible. It is the most stringent standard for fire performance of materials and gives a measure of heat and flames generated by the material under standard heating conditions. Non combustible materials can be used without restriction in any part of building construction and finishing. Their use ensures that hazards due to smoke and toxic gases are minimised and that the fabric of a building makes no contribution to a fire. All Promat board and cementitious spray products are classified as non combustible.

AS 1530: Part 3: 1999

“Simultaneous determination of ignitability, flame propagation, heat release and smoke release”

This standard is used to assess early fire hazard of building materials and components according to their tendency to ignite and to propagate flame, their heat release once ignition has occurred and the likelihood of smoke release. Four indices generated by the test are ignitability, spread of flame, heat evolved and smoke evolved.

AS/NZS 3837: 1998

“Method of test for heat and smoke release rates for materials and products using an oxygen consumption calorimeter”

The test method is used to determine the ignitability, heat release rates (HRR), mass loss rates, effective heat of combustion and smoke release of materials and products. The method of performance measurement uses a cone calorimeter for measurement of the HRR time to ignition and smoke production.

Fire resistance test standards – fire reaction in testing of construction systems

This category provides the necessary details related to the ability of a specimen of system construction to prevent the spread of flame or smoke in a fully developed fire and maintain structural stability of the tested specimen.

Testing the fire resistance of a building element involves determining its behaviour when exposed to a particular heating condition and pressure, normally those representing a fire in an enclosed space, e.g. a room. Fire resistance is one of several properties of the structure or system, and thus is not simply a property of the specific materials used in the structure or system.

AS 1530: Part 1: 1994

“Combustibility tests for materials”

This describes a classification of materials as either non combustible or combustible. It is the most stringent standard for fire performance of materials and gives a measure of heat and flames generated by the material under standard heating conditions. Non combustible materials can be used without restriction in any part of building construction and finishing. Their use ensures that hazards due to smoke and toxic gases are minimised and that the fabric of a building makes no contribution to a fire. All Promat board and cementitious spray products are classified as non combustible.

AS 1530: Part 3: 1999

“Simultaneous determination of ignitability, flame propagation, heat release and smoke release”

This standard is used to assess early fire hazard of building materials and components according to their tendency to ignite and to propagate flame, their heat release once ignition has occurred and the likelihood of smoke release. Four indices generated by the test are ignitability, spread of flame, heat evolved and smoke evolved.

AS/NZS 3837: 1998

“Method of test for heat and smoke release rates for materials and products using an oxygen consumption calorimeter”

The test method is used to determine the ignitability, heat release rates (HRR), mass loss rates, effective heat of combustion and smoke release of materials and products. The method of performance measurement uses a cone calorimeter for measurement of the HRR time to ignition and smoke production.

Assessments and/or appraisals

Test reports only state what has been tested and show no variations. Changes to a construction tested to Australian, British or European standards will require either another fire test or an engineering assessment.

An assessment is a desktop study undertaken by an independent fire consultant and allowing some variations from a tested design. The nature and scope of any variation will depend to a large extent on the size and configuration of the test specimen.

Project specific assessments can also be produced, tailored to the specific needs of a building project.

Vocabulary of fire resistance performance criteria

Fire resistance

Ability of an item to fulfil for a stated period of time the required fire stability and/or integrity and/or thermal insulation and/or other expected performance specified in a standard fire resistance test.

Integrity

The ability of a specimen of a separating element to contain a fire to specified criteria for collapse, freedom from holes, cracks and fissures and sustained flaming on the unexposed face.

Insulation

The ability of a specimen of a separating element to restrict the temperature rise of the exposed face to below specified levels (140°C mean rise, 180°C maximum rise).

Loadbearing capacity

The ability of a specimen of a loadbearing element to support its test load, where appropriate, without exceeding specified criteria with respect to either the extent or rate of deformation. Please note that within AS 1530: Part 4: 2005, loadbearing capacity is described by the term "structural adequacy".

Stability

The ability of a system, e.g. ventilation and smoke extraction ductwork, to maintain in place and capable of fulfilling its intended function throughout the duration of exposure to fire. Please note that within AS 1530: Part 4: 2005, stability is described by the term "structural adequacy".

Fire resistance performance in accordance to EN 13501: Part 2 is described as follows:

- R** The structural element should not collapse or deflect beyond the permitted levels when subjected to the applied load.
- E** The integrity of the room must be maintained. No breakthrough of flames is permitted.
- I** The temperature on the non exposed side of the structural element must not rise more than 140°C above ambient as an average measurement and no more than 180°C at any one location.



Autoclaved matrix engineered mineral board

Promat manufactures a number of autoclaved matrix engineered mineral boards, including PROMATECT®-H, PROMATECT®-L500 and PROMATECT® 100. The autoclave process exposes the mixture of raw materials to elevated temperatures and pressures to create the board products with versatile and beneficial properties, such as:

- Non combustibility
- Good impact and abrasion resistance
- Moisture tolerance
- Good dimensional stability
- Stability in fire conditions
- Good insulation properties when exposed to fire

The fire insulation properties of Promat's matrix engineered mineral boards are mainly due to the presence of a controlled moisture content held within the board.

PROMATECT®-H is a laminated cementitious board which is subjected to heat and pressure in an autoclave to form a sturdy, multi purpose matrix engineered mineral board.

PROMATECT®-L500 is a monolithic matrix engineered mineral board formed by pressing together autoclaved spheres (known as PROMAXON® technology).

How PROMAXON® technology works

PROMAXON® is a synthetic hydrated matrix engineered mineral in spherical form. The outer shell of close-knit micropores forms the linking network for the mineral matrix of the PROMATECT® 100 board. This is a key factor in the board's cohesion and stability in fire conditions. A mineral additive acts as filler in the gaps between the spherical PROMAXON® particles.

In fire, the release of free water within the board, and then the chemically bound water from the mineral matrix, cause a cooling effect which reduces the temperature rise on the non fire side of the board. However, before the water can escape from the board, the PROMAXON® spheres recapture part of the water that has been released. This then creates a further

endothermic process that gradually releases the recaptured water molecules, thus creating a further drop in the rate of temperature rise.

As a result, PROMATECT® 100 is a creation of new generation Promat boards that combine the advantages of traditionally manufactured matrix engineered mineral and gypsum boards AND outstanding advantages of the PROMAXON® technology.

Improved PROMATECT® 100

PROMATECT® 100 is a hybrid development of matrix engineered mineral and gypsum board using PROMAXON® technology. The composition of the new PROMATECT® 100 board contains a key component which improves the fire insulation of the product – thanks to an endothermic process which produces a chemical change accompanied by the absorption of heat!

The critically important component is autoclaved matrix engineered mineral spheres bound in a mineral matrix. It is PROMAXON® technology in combination with the mineral matrix that eventually creates the endothermic process when exposed to fire. The end result is significantly better fire insulation than that provided by either traditional matrix engineered mineral boards or gypsum boards.

The new PROMATECT® 100 boards have both a small amount of free water in the PROMAXON® spheres and chemically bound water in the mineral matrix. By producing more water and retaining it longer within the board, fire insulation is therefore improved.

Advantages:

- Superior insulation properties when exposed to fire
- Excellent workability and easy to cut
- High flexural strength – capable to form curved lining
- Low wall section footprint
- Installation by carpentry trades
- Proven cost effective lightweight drywall systems

Product properties

PROMATECT® 100 comprises autoclaved calcium silicate spheres bound in a mineral matrix. This PROMAXON® technology – a synthetic hydrated calcium silicate in spherical form – provides excellent performance in most fire resistant applications.

All below properties are mean values given for information and guidance only. If certain properties are critical for a particular application, it is advisable to consult Promat. PROMATECT® 100 is manufactured under a quality management system certified in accordance with ISO 9001: 2008. The product has passed the site audit in accordance with the environmental standards of ISO 14001: 2004 and occupational health and safety requirements of OHSAS 18001: 2007.

PROMATECT® 100 is off-white in colour. The front face is smooth and is suitable for any forms of architectural/finishing treatment; the reverse face is sanded.

PROMATECT® 100 is resistant to moist conditions and will not physically deteriorate in a humid environment. Whilst its performance characteristics are not degraded by moisture or ages, PROMATECT® 100 is not designed for application in areas subject to continual damp or high temperatures. The product is recommended for interior applications only.

Material properties

Generic description	PROMAXON® mineral board
Surface condition	Front face: smooth Back face: sanded
Building regulations	Class 0
Alkalinity	Approx. pH 9
Coefficient of expansion	-16 x 10 ⁻⁶ m/mk
Thickness tolerance	±0.5mm (standard thickness boards)
Dimension tolerance	±0-3mm (standard dimension boards)

Physical performance

Property	Test method	Test results
Density	BS EN 323	Nominal 850kg/m ³
Flexural strength, F_{rupture}	BS EN 310	Longitudinal 4.5N/mm ²
Tensile strength, T_{rupture}	BS 5669: Part 1	Longitudinal 1.02N/mm ² Transverse 0.98N/mm ²
Compressive strength	BS 5669: Part 1	5.99N/mm ²
Combustibility	BS 476: Part 4 AS 1530: Part 1 DIN 4102: Part 1	Non combustible
Surface burning	BS 476: Part 7 AS/NZ ISO 53837	Class 1 (cone calorimeter test group 1)
Simultaneous determination of ignitability, flame propagation, heat and smoke release	AS 1530: Part 3	Indices 0/0/0/0-1
Thermal conductivity	ASTM C518	Approx. 0.164W/mK at 20°C
Typical moisture content	BS EN 322	Average 12.72%

Application

- Structural steel fire protection
- Steel/timber stud and solid/frameless partitions
- Self-supporting ceilings
- Timber floor and mezzanine floor protection
- Access hatches and fire doors

Health and safety

When machining the PROMATECT® 100 product, airborne dust may be released, which may be hazardous to health. Do not inhale the dust. Avoid contact with skin and eyes. Use dust extraction equipment. Respect regulatory occupational exposure limits for total inhalable and respirable dust. A health and safety data sheet is available from Promat and, as with any other material, should be read before working with the product.

PROMATECT® 100 product is not classified as a dangerous substance so no special provisions are required regarding the transportation and the disposal of the product to landfill. The product can be placed in on-site rubbish skips with other general building waste which should then be disposed by a registered contractor in the appropriate and approved manner.

Standard thickness	Standard dimension	Number of boards per pallet	Surface per pallet	Weight of boards per m ²	Weight per pallet
8mm	2500mm x 1200mm	50	150m ²	Approx. 7.1kg	Approx. 1140kg
10mm	2500mm x 1200mm	40	120m ²	Approx. 8.8kg	Approx. 1110kg
12mm	2500mm x 1200mm	30	90m ²	Approx. 10.6kg	Approx. 1020kg
15mm	2500mm x 1200mm	25	75m ²	Approx. 12.8kg	Approx. 1010kg
18mm	2500mm x 1200mm	20	60m ²	Approx. 15.3kg	Approx. 965kg
20mm	2500mm x 1200mm	20	60m ²	Approx. 17.0kg	Approx. 1070kg
25mm	2500mm x 1200mm	15	45m ²	Approx. 21.3kg	Approx. 1010kg

Safety data sheet (SDS)**Product identifier**

PRODUCT NAME	PROMATECT® 100
PRODUCT FORM	Article
TYPE OF PRODUCT	Self-supporting mineral board
PRODUCT GROUP	Fire protective board
FUNCTION / USE CATEGORY	Professional fire protection applications in building and construction industry.
MARKETED BY	Promat Asia Pacific organisation

Composition

SUBSTANCE	Not applicable
MIXTURE	Not applicable
ARTICLE	Calcium silicate hydrates, calcium sulphate hydrates, cellulose fibres and glass fibres.

Hazards identification

CLASSIFICATION	This product does not meet the criteria for classification in any hazard class according to the CLP Regulation No. (EC) 1272/2008 on classification, labelling and packaging.
OTHER HAZARDS	No hazards known for the installed product in its final application. During machining the product (drilling, cutting, sanding etc), airborne dust can be released. As with most types of nuisance dust, excessive inhalation of dust may cause irritation of the bronchial tubes. Eye irritation, irritation of mucous membranes and skin irritation can occur.

First aid measures

SKIN CONTACT	Wash off immediately with plenty of soap and water.
EYE CONTACT	Do not rub the eye. Rinse immediately with plenty of water. Seek medical attention if irritation or symptoms persist.
INHALATION	Remove to fresh air and drink plenty of water.
INGESTION	Rinse mouth and drink plenty of water.

SEEK MEDICAL ATTENTION IF ILL EFFECT OR IRRITATION DEVELOPS.

PROMATECT® 100 is an article within the meaning of REACH (REGULATION (EC) No. 1907/2006), with its amendment REGULATION (EU) 2015/830, and CLP (REGULATION (EC) No. 1272/2008). SDSs do not have to be provided for articles. Moreover this article, for which safety information is given, does not contain substances of very high concern, substances of which the use is restricted by the Commission or substances on the Candidate List of Substances of Very High Concern for Authorization (last updated list of 8th February 2016). Even if this article is not subjected to any obligation to classify or label (Art 4 of Regulation (EC) No. 1272/2008), Promat has decided to supply several information about identification, first aid and releases measures, exposure control, disposal and transport. This safety information supplies information to industrial and professional users on the safe use of this article.

Safety data sheet (SDS)

First aid measures

MOST IMPORTANT SYMPTOMS AND EFFECTS, BOTH ACUTE AND DELAYED:

SKIN CONTACT	Prolonged skin contact may lead to skin irritation for sensitive persons.
EYE CONTACT	Eye contact with dust may lead to transient eye irritation or inflammation.
INHALATION	May cause irritation to the respiratory tract and to other mucous membranes.
INGESTION	Not expected to present a significant ingestion hazard under anticipated conditions of normal use.

TREAT SYMPTOMATICALLY FOR INDICATION OF ANY IMMEDIATE MEDICAL ATTENTION AND SPECIAL TREATMENT NEEDED.

Firefighting measures

EXTINGUISHING MEDIA	All suitable extinguishing media can be used.
EXPLOSION HAZARD	The product is not explosive.
REACTIVITY IN CASE OF FIRE	The product is non combustible.
HAZARDOUS DECOMPOSITION PRODUCTS IN CASE OF FIRE	Not combustible.
ADVICE FOR FIREFIGHTERS	Do not enter fire area without proper protective equipment, including respiratory protection. Wear protection during firefighting.

Accidental release measures

PERSONAL PRECAUTIONS	<p>Minimise generation of dust. Avoid breathing dust. Avoid eye and skin contact. Dampen down any dust or use vacuum cleaner with correct filter.</p> <p>For non emergency personnel Use recommended respiratory protection. Prevent spread of dust. Dampen down any dust or use vacuum cleaner with correct filter.</p> <p>For emergency responders Use personal protective equipment as required. Stop dust release.</p>
ENVIRONMENTAL PRECAUTIONS	Prevent spread of dust.
CLEAN UP METHODS	Use closed containers to avoid dust release. Shovel up small pieces. Dampen down any dust before putting into appropriate skips.

PROMATECT® 100 is an article within the meaning of REACH (REGULATION (EC) No. 1907/2006), with its amendment REGULATION (EU) 2015/830, and CLP (REGULATION (EC) No. 1272/2008). SDSs do not have to be provided for articles. Moreover this article, for which safety information is given, does not contain substances of very high concern, substances of which the use is restricted by the Commission or substances on the Candidate List of Substances of Very High Concern for Authorization (last updated list of 8th February 2016). Even if this article is not subjected to any obligation to classify or label (Art 4 of Regulation (EC) No. 1272/2008), Promat has decided to supply several information about identification, first aid and releases measures, exposure control, disposal and transport. This safety information supplies information to industrial and professional users on the safe use of this article.

Safety data sheet (SDS)

Handling and storage

ADDITIONAL HAZARDS	Dust, generated during machining and processing, must be exhausted. The regulatory Occupational Exposure Limits (OEL) for total and respirable dust and respirable quartz dust must be respected.
PRECAUTIONS	Always use respiratory protective equipment when exposures are likely or can be foreseen to exceed the local/national OEL. Collect dust with a vacuum cleaner or soak with water before sweeping up. Ensure good ventilation of the work station. Use tools with appropriate dust exhaust equipment.
HYGIENE MEASURES	Do not eat, drink or smoke when using the product. Always wash hands after handling the product.
STORAGE CONDITIONS, INCLUDING ANY INCOMPATIBILITIES	Store in dry, covered and frost proof area.

Exposure controls / Personal protection

ENGINEERING CONTROLS	When machining boards (drilling, cutting, sanding etc), respect OEL for inhalable and respirable dust. Check the latest local/national OEL) for airborne contaminants that are applicable.
PERSONAL PROTECTION	Ensure vacuum dust exhaust with correct filter when using motorised machining tools. Use dust mask for dust formation.
RESPIRATORY PROTECTION	Avoid breathing dusts. Use appropriate respiratory equipment when exposures are likely or can be foreseen to exceed the OEL (e.g. use at least a P2 type duct mask for exposures up to 10 times).
EYE PROTECTION	Avoid contact with eyes. Use safety glasses whenever tools are used and dusts are produced.
SKIN AND BODY PROTECTION	Avoid contact with skin. Use working clothes and gloves to protect against mechanical injury and direct skin contact.
ENVIRONMENTAL EXPOSURE CONTROLS	Avoid release to the environment.

Physical and chemical properties

PHYSICAL STATE	Solid
COLOUR	Off white
ODOUR	None
pH	≈ 9
FLAMMABILITY (SOLID / GAS)	Not flammable
DENSITY	≈ 875kg/m ³

PROMATECT® 100 is an article within the meaning of REACH (REGULATION (EC) No. 1907/2006), with its amendment REGULATION (EU) 2015/830, and CLP (REGULATION (EC) No. 1272/2008). SDSs do not have to be provided for articles. Moreover this article, for which safety information is given, does not contain substances of very high concern, substances of which the use is restricted by the Commission or substances on the Candidate List of Substances of Very High Concern for Authorization (last updated list of 8th February 2016). Even if this article is not subjected to any obligation to classify or label (Art 4 of Regulation (EC) No. 1272/2008), Promat has decided to supply several information about identification, first aid and releases measures, exposure control, disposal and transport. This safety information supplies information to industrial and professional users on the safe use of this article.

Safety data sheet (SDS)

Stability and reactivity

REACTIVITY	Non reactive under normal conditions of use, storage and transport.
CHEMICAL STABILITY	Stable under normal conditions.
POSSIBILITY OF HAZARDOUS REACTIONS	No dangerous reactions known under normal conditions of use.
CONDITIONS TO AVOID	None under recommended storage and handling conditions (see Handling and storage).
INCOMPATIBLE MATERIALS	Strong acids
HAZARDOUS DECOMPOSITION	Under normal conditions of storage and use, hazardous decomposition products should not be produced.

Toxicological information

TOXICOLOGICAL EFFECTS	Not classified. No acute toxicity has been reported, apart from some exceptional cases of transient eye irritation or inflammation, skin irritation or irritation of the mucosae (throat, bronchial tubes) by excessive exposure to dust.
SKIN CORROSION/IRRITATION	Not classified (pH ≈ 9)
SERIOUS EYE DAMAGE/IRRITATION	Not classified (pH ≈ 9)
OTHER INFORMATION	The fibres used in this product do not meet the definition of critical or respirable fibre as defined by WHO convention because of their large diameter. Because the fibres are considered as non-respirable, they are not expected to pose a cancer risk.

Ecological information

The product is generally not considered harmful to aquatic organisms nor to cause long-term adverse effects in the environment.

COMPONENT	Silicic acid, calcium salt (1344-95-2) This substance/mixture does not meet the PBT criteria of REACH regulation, annex XIII. his substance/mixture does not meet the vPvB criteria of REACH regulation, annex XIII.
-----------	--

Disposal considerations

WASTE TREATMENT METHODS	Handle as construction industry waste.
WASTE DISPOSAL RECOMMENDATIONS	Dispose in a safe manner in accordance with local/national regulations.

PROMATECT® 100 is an article within the meaning of REACH (REGULATION (EC) No. 1907/2006), with its amendment REGULATION (EU) 2015/830, and CLP (REGULATION (EC) No. 1272/2008). SDSs do not have to be provided for articles. Moreover this article, for which safety information is given, does not contain substances of very high concern, substances of which the use is restricted by the Commission or substances on the Candidate List of Substances of Very High Concern for Authorization (last updated list of 8th February 2016). Even if this article is not subjected to any obligation to classify or label (Art 4 of Regulation (EC) No. 1272/2008), Promat has decided to supply several information about identification, first aid and releases measures, exposure control, disposal and transport. This safety information supplies information to industrial and professional users on the safe use of this article.

Safety data sheet (SDS)

Transport information

Not dangerous for the environment in accordance with ADN, ADR, IATA, IMDG and RID.

No marine pollutant in accordance with IMDG.

No special precautions for transport user in air, inland waterway, overland, rail and sea.

Regulatory information

SAFETY, HEALTH AND ENVIRONMENTAL REGULATIONS/LEGISLATION SPECIFIC FOR THE SUBSTANCE OR MIXTURE

EU-REGULATIONS Contains no substance on the REACH candidate list.

CHEMICAL SAFETY ASSESSMENT No assessment has been carried out,

Other information

SAFETY INFORMATION
APPLICABLE FOR REGIONS CY;GB;GI;IE;IS;MT

DISCLAIMER OF LIABILITY The safety information given in this document was obtained from reliable sources. However, the information is provided without any warranty, express or implied, regarding its correctness. The conditions or methods of handling, storage, use or disposal of the product are beyond the control and may be beyond the knowledge of Promat. For this and other reasons, Promat shall not assume responsibility and expressly disclaim liability for loss, damage or expense arising out of or in any way connected with the handling, storage, use or disposal of the product. This safety information was prepared and is to be used only for this product. If the product is used as a component in another product, this safety information may not be applicable. This data sheet and the information it contains is not intended to supersede any terms or conditions of sale and does not constitute a specification. Nothing contained herein is to be construed as a recommendation for use in violation of any patent or applicable laws or regulations.

PROMATECT® 100 is an article within the meaning of REACH (REGULATION (EC) No. 1907/2006), with its amendment REGULATION (EU) 2015/830, and CLP (REGULATION (EC) No. 1272/2008). SDSs do not have to be provided for articles. Moreover this article, for which safety information is given, does not contain substances of very high concern, substances of which the use is restricted by the Commission or substances on the Candidate List of Substances of Very High Concern for Authorization (last updated list of 8th February 2016). Even if this article is not subjected to any obligation to classify or label (Art 4 of Regulation (EC) No. 1272/2008), Promat has decided to supply several information about identification, first aid and releases measures, exposure control, disposal and transport. This safety information supplies information to industrial and professional users on the safe use of this article.

Loading/uploading, storage and handling of boards

Loading/uploading

PROMATECT® 100 boards are supplied on pallets suitable for fork lift unloading. If off-loading by crane and slings is envisaged, care should be taken to avoid damaging edges of the boards. All pallets and crates can be safely handled by using a fork lift or hoisting equipment and straps. Steel cables or chains should not be used as they will damage both the pallet and the boards. Where crates are removed from a box container, care should be taken not to subject crates and pallets to any impact shock, as this could result in cracking of the boards.

Always drive the delivery vehicle as close as possible to where the boards are to be used. When transporting the boards, it is essential to secure the pallets to prevent sliding. If the boards are subsequently moved around the site, they should be placed on a rigid base suitable for lifting by forklift. PROMATECT® 100 boards should always be stored on a rigid base.

Storage

PROMATECT® 100 boards are supplied with protective plastic sheet wrapped around the timber crates. This protection should not be removed until the boards are ready for use.

In general, the following steps should be taken to ensure that the boards remain in good condition during storage.

- a) The boards should be stored and stacked on covered and dry, level ground, away from the working area or mechanical plant.
- b) Pallets should be a maximum of 800mm height ($h \leq 800\text{mm}$) on firm level ground. If two or more pallets are stacked, the total stack height must be less than 3200mm ($H \leq 3200\text{mm}$).



- c) The stacked boards must be stored under cover completely for protection from inclement weather.



Handling

Following recommendation must be always taken into account when handling PROMATECT® 100 boards:

- a) Wherever possible, always lift the boards from underside rather than slide the boards on each other on the stack to prevent damage or scratches on surface of the boards.



- b) Always carry the boards on edge but do not store on the edge.



Cutting

Promat recommends that all cutting be carried out in well ventilated spaces, using dust extraction facilities. Operators should wear protective face masks at all times.

There are a wide variety of applications and fixing methods possible with PROMATECT® 100 boards. The method to be used is dependent on a number of factors, including:

- 1) The shape of the board's final application, be it square, rectangular or circular etc.
- 2) The location where the work is to be carried out, be it industrial, commercial, on or off site etc.
- 3) The quality of workmanship required.

PROMATECT® 100 boards can be cut on site fairly easily. However, if a large number of boards are to be cut, it is recommended that cutting is carried out off site under controlled conditions as much as possible to ensure good quality of finished edges etc.

A few general rules should be observed when working with the boards as follows:

- For industrial quality cutting and extended cutting life of tools, working with diamond tipped saws is recommended. Experience shows that tools with tungsten carbide blades provide a more than adequate cut.
- High speed electric tools generate very fine dust. Inhaling fine dust can be harmful to health, dust extraction equipment or wet cutting is thus necessary. Although PROMATECT® 100 boards contain no harmful fibres, inhalation of excessive nuisance dust can be detrimental. It is also recommended that when cutting or drilling the boards, appropriate face masks and personal protection equipment (PPE) should always be worn.
- Slow running tools produce coarse dust or chips but are not so efficient at cutting.
- The speed of cutting is best determined by thickness of the board, hardness of the board and condition of the blade.
- Boards must be held securely during cutting to avoid slippage and vibration which can lead to chipping of the board edges.
- The choice of the most appropriate tool for use in each country will depend on custom, practice and local regulations.

Guillotine

The knife of the guillotine is parallel to the board support so that a consistent, even cut is made at the same moment over the entire length of the board. Up to a maximum thickness of 6mm, a reasonably neat, square cut can be achieved but the

edge remains rough. The machine cuts the sheets one by one and is not suitable for textured surfaces.

Tungsten carbide blades

Tungsten carbide tipped saws can be used with either a high or low speed electric motor. The cutting is done in a dry state so dust extraction is essential. The tungsten carbide teeth of the saw have a shorter life span than diamond tipped blades but they can be sharpened by a skilled professional.

Diamond tipped blades

Cutting with diamond tipped blades is carried out using high speed electric motor at 2500-3000rpm depending on diameter of blade. There are two types:

- 1) Machine with fixed table and moving saw support
- 2) Machine with fixed saw support and moving table

The saw support can be equipped with several parallel saws for multi cutting in a single pass of the blades over the boards. A diamond tipped blade can be used in either a wet or dry state.

The disadvantage of wet cutting is the generation of cement slurry which forms from the mixture of the dust and water. This must be drained off in an appropriate way. In addition, it is necessary to rinse the saw after each use to maintain the cutting quality. Wet cutting is not an ideal solution for PROMATECT® 100 boards.

The boards should be cleaned after cutting to avoid leaving any dust on the surface.

Diamond blades can be used to cut more than one board at a time, depending on the diameter of the saw blade and the thickness of the boards.

Industrial machines

Industrial machines are used for continuous cutting over long periods of time, for large quantities and for better efficiency. Standard industrial machine is for dry cutting and is available in high and low speed electric motors.

High speed electric motor with diamond tipped blades can be used for other building materials such as concrete, natural stone, brick etc. Low speed motor with tungsten carbide tipped blades is more suitable for cutting fibre cement materials.

Cutting PROMATECT® boards with low speed motor provides a neat cut and smooth edges.

On site machines

While working at site, hand tools and low speed electric tools are generally recommended. When high speed electric tools are used, dust extraction is essential.

Power tools with dust extraction equipment

Sawing machines such as FESTO, Bosch, Makita etc work with a tungsten carbide tipped saw blade on a low speed electric motor and move over a fixed working table. It is a typical machine for occasional use on site producing very good results and is capable of cutting boards with maximum thickness up to 25mm.

A vacuum cleaner is recommended for use while cutting especially when using power saws. As an additional safety precaution, always wear eye, ear and dust protection when using power tools of any type. A portable version of the working table is available for the convenience of board cutting on site.

While working with power saws, the following important points should be observed:

- Ensure that the boards to be cut are continuously and well supported on either side of the cut.
- A straight edge should be clamped in position to guide the cutting operation.
- Care must be taken to ensure the tool remains against the straight edge during the cutting operation.
- The cutting rate should be such that the blade is not labouring or over-heating. Feed speed for fibre cement boards is normally slower than for natural timber.

Jigsaw



This is applicable for panels up to 25mm thick. The panels can be cut easily with a jigsaw to form various shapes. Blades with special hardened teeth are available for cutting PROMATECT® 100 boards. As with all power tools, care should be taken to cut within the capacity of the tool and blade. Do not force the cutting speed.

Scoring knife

This tool is equipped with a tungsten carbide tipped point. It is suitable for use with panels up to 6mm thick. Several passes using a straight edge to guide the knife are required on the board surface to create an increasingly deep scored groove. The final break is obtained by applying pressure on the unsupported part of the board. The cut is relatively neat but the edge should be finished with glass paper or a manual or electric plane.

Hand saw



Hand sawing is suitable for general cutting operations and for small cuts, notchings or small penetrations. However, this method of cutting can be rather time intensive. The fastest way is to allow the saw to work at its own speed, trying to force the tool to cut faster merely blunts the teeth.

Drilling



Drilling can be carried out either by hand drill or any conventional power drill with or without dust extraction. For best results, the boards should be firmly supported behind the location of the holes. Generally when working on PROMATECT® 100 boards, the use of drills with point angles of 60° to 80° rather than the more usual 120° type, are preferable and more efficient.

Rasp/surform

A rasp or surform can be used for edge finishing where necessary in order to trim away rough edging. For optimum edge finishing, dress the edges with fine glass paper.

Fixing and fabrication

PROMATECT® 100 boards are easy to handle and work using conventional tools. However, basic standard safety precautions should be routine at all times during installation.

This section highlights some general guidance in fixing and fabrication of the boards for fire resistant applications. Following tools are recommended:



The type of fixings used when installing PROMATECT® 100 boards are important as they determine the support of joints and stability of a structure. In general, a fixing should meet these rules and requirements:

- 1) Corrosion resistant.
- 2) Stainless steel or galvanised nails are recommended for timber framing. Do not use screws when the board forms part of the structural bracing, unless tested with such fixings.
- 3) Stainless steel, zinc or other plated self-drilling screws are recommended for steel framing.
- 4) Fixing points should be located at least 12mm from the board edge and 50mm and 100mm from board corners. Nominal centres of fixing are generally recommended at 200mm throughout this handbook.

Nailing

The most economical method of fastening is to use pneumatic nailing and stapling equipment.

When fixing PROMATECT® 100 boards with nails, the following should be noted clearly:

- Do not over drive the fixings, as this may reduce the holding capacity of the fixing to the board.
- Fixings should be driven straight into the board and

at best embedded no more than 0.5mm below the board surface.

- Do not damage the board around the fixing or at its edges. Cracked sheets should be replaced.

Nails can be driven directly through the boards into timber framing, without predrilling, provided they are at least 12mm from the edge of the board and the back face of the board is fully supported while drilling.

In areas of high humidity, galvanised nails should be used. Panel pins, oval or lost head nails should not be used. Wire or clout nails are acceptable. Nails should be located 50mm and 100mm from corners.

Use below fixing guide in conjunction with the illustration:

From edge	From corner	Centres at edge	Centres from midpoint
Minimum 12mm	50mm and 100mm	Depends on product and system. Please consult Promat.	

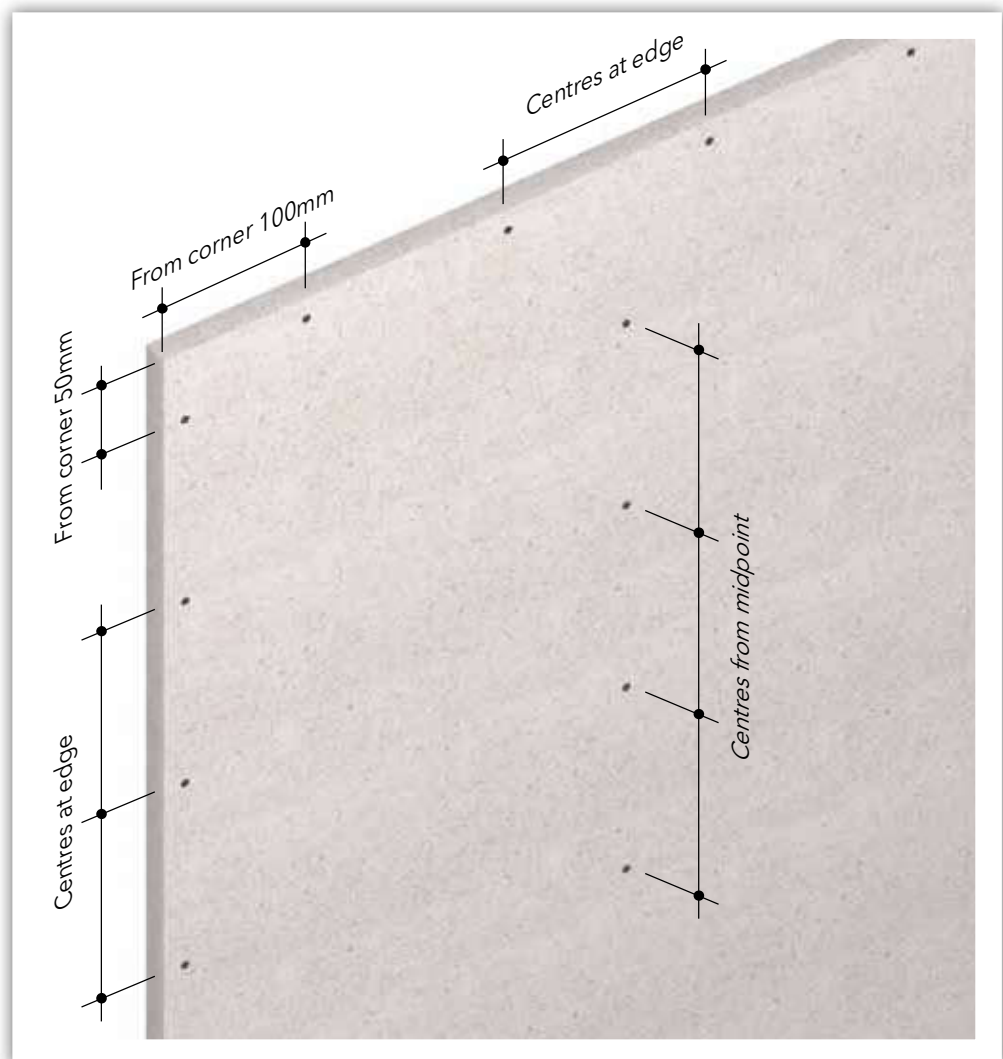

Fixing and fabrication

Screw fixing

When fixing PROMATECT® 100 boards, especially to steel frames, the following should be noted:

- Always predrill fixing holes unless using specially designed self-drilling screws suitable for fixing fibre cement to steel.
- Use a high torque, variable speed screw gun fitted with a depth gauge.
- Do not over drive, as this may reduce the holding capacity of the screw. Reduce drill speed as the screw pulls the board against the framing.

When fixing to steel framing, always fix to the open side of the flange first in order to maintain a flush outside face (see the illustration for the correct sequence of installation).

Pilot holes should be predrilled not less than 12mm from the edge of the boards and countersunk if required. Use self-drilling or self-tapping screws when securing boards to steel.

In most other situations, drywall screws (e.g. Hilo) are generally suitable. Board thicknesses greater than 15mm can be screwed board to board.

Self-drilling or self-tapping screws are suitable. If fixing board to board, minimum screw penetration should be 25mm or twice the board thickness, whichever is greater. If screws do not have a deep thread, pilot holes should be drilled and care should be taken not to over turn or over drive. Screws should be 50mm and 100mm from corners.

Adhesive fixing

Multi purpose glue or bonding compound can be used for non fire resistant applications. Please consult Promat for further details.

Staple fixing

PROMATECT® 100 boards may be stapled to timber supports using an industrial staple gun. Staples may also be used for edge to edge fixing of boards 15mm or greater in thickness. Staples may be used when fire resistance is required, please consult Promat for further information.

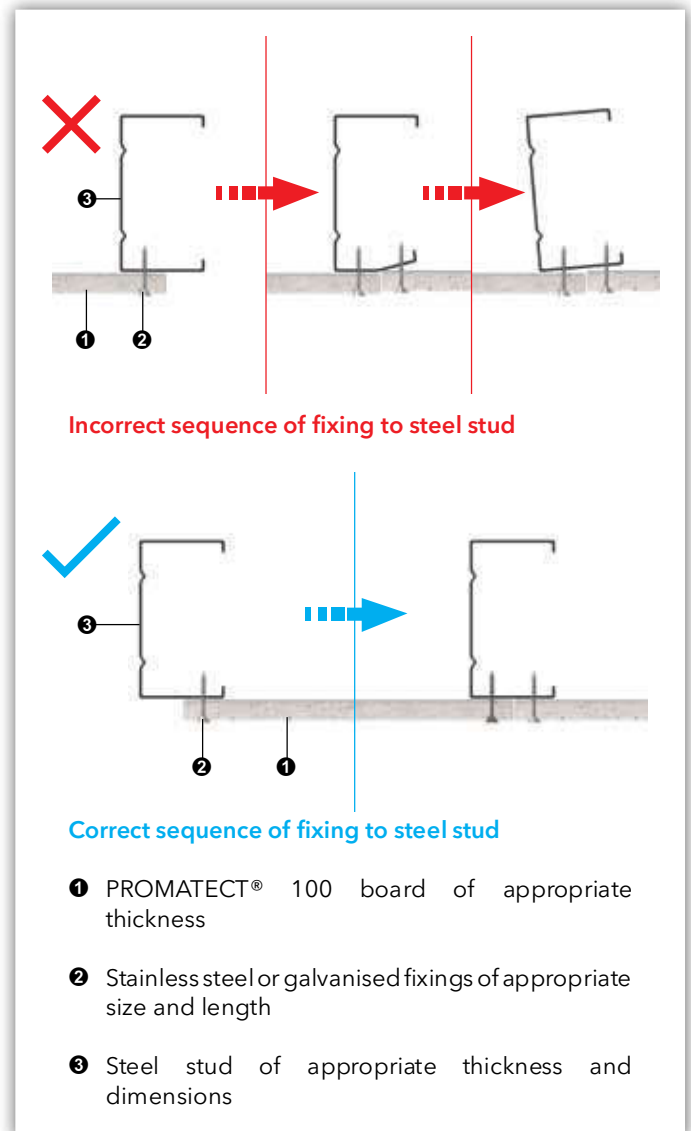

Fixing and fabrication

Forming holes

Apertures often need to be cut within a board to allow for penetration of services such as switchboxes, lights, access panels etc. The following procedures therefore serve as general guidelines only. Any method that allows for cutting of holes without damaging the board is acceptable.

1) For smooth, clean cut circular holes:

- Mark the centre of the hole on the board.
- Pre-drill a hole to be used as a guide.
- Cut the hole to the require diameter using a hole saw fitted to a heavy duty electric drill where the central bit is inserted into the predrilled hole or use a jigsaw.

2) For small irregular holes:

- Small rectangular apertures can be achieved by forming a series of small holes (using a drill) around the perimeter of the opening.
- Carefully tap out the waste piece from the panel face. Make sure that the edges are properly supported in order to avoid damage to boards.
- Rough edges can be cleaned with a rasp or 40 grit glass paper.

Below example of nailing and hammering for openings.

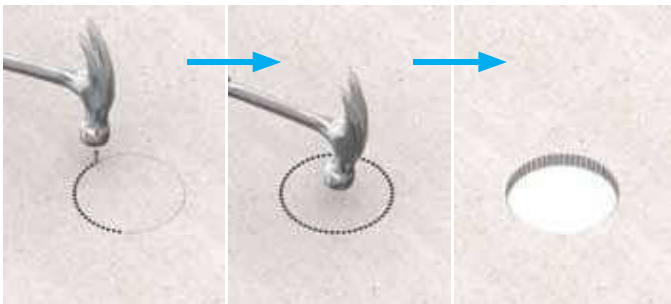

3) For large openings or apertures:

- Score deeply around the perimeter of the opening using a sharp tool (for thin boards only).
- Form a large round hole in the centre using the method previously described.
- Saw cut from the centre towards the corners of the opening.
- Tap waste pieces from the face side and if necessary clean rough edges with a rasp or with at least 40 grit sand paper. Radius corners with a half round rasp to eliminate any stress points.

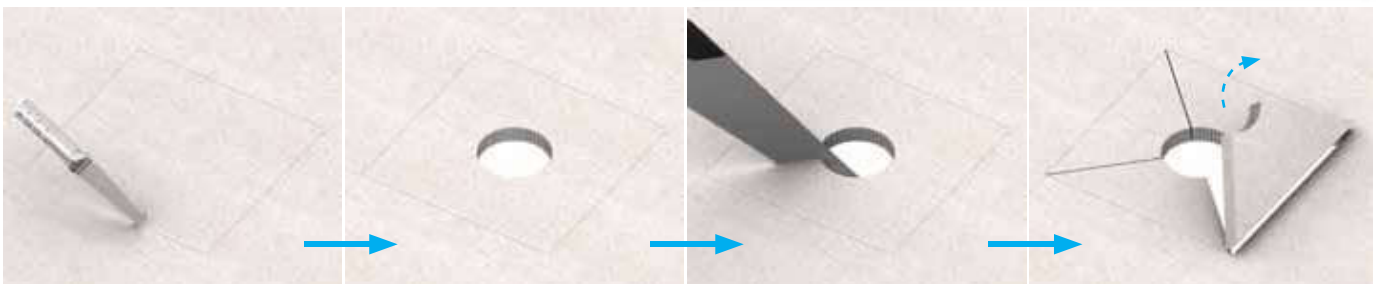

Alternatively, for neater openings:

- Pre-drill a hole of at least 10mm diameter at the four corners of the openings. Mark lines from hole to hole (forming a rectangular shape) as a guide and cut along the lines using a jigsaw or hand saw.
- Clean rough edges of the hole with a rasp.

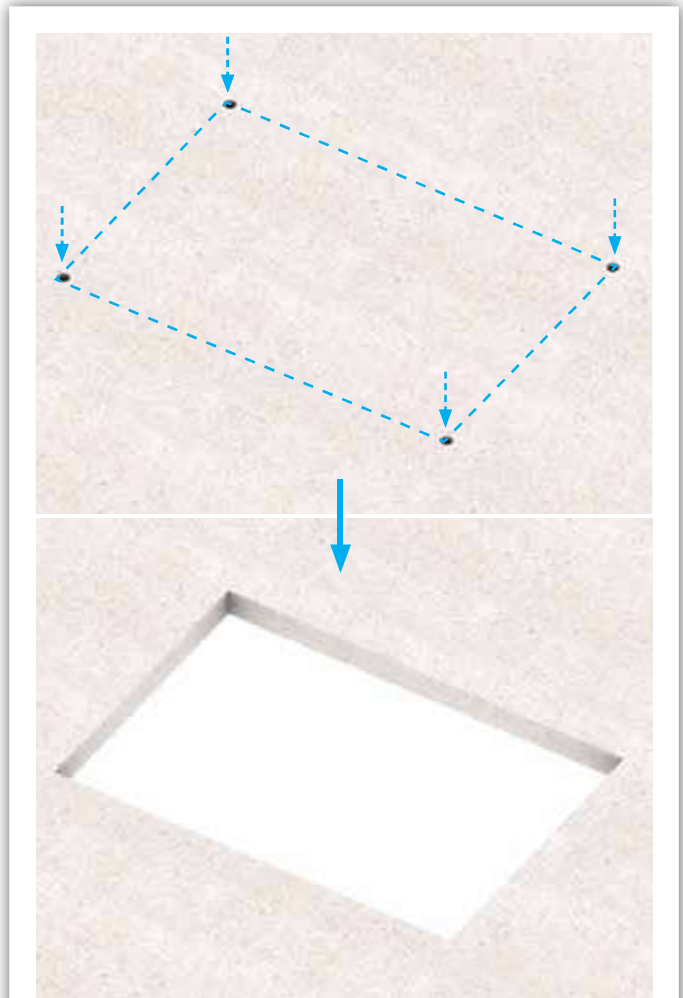

Apertures opening using alternative method: Never make holes by using heavy hammers, cold chisels or other "aggressive" methods. This will damage the underside of the boards and adversely effect the fire performance of the system.

Flush jointing between boards

PROMATECT® 100 boards can be simply butt jointed with sheets having square edges. If required, a filler may be used to finish joints before decoration.

Flush jointing is applicable to most partition and ceiling constructions. However, in some instances it may be also applicable to external wall constructions.

Generally, installations of concealed framed ceiling and partition systems require crack-free flush jointing. The method of constructing flush joints depends very much on the skills and expertise of the installer, as well as the stability of the supporting construction.

It is recommended that the thickness of panels used for flush jointing should be at least 7mm thick. Thinner boards are used only when they are to be rendered with synthetic binders or textures at a later stage.

Following are some guidelines for joint finishing that will help achieve the required professional appearance. To obtain a good flush joint, it is important that all panels have bevelled or recessed edges at the side where they abut other panels.

Note that when a panel is cut to size on site, the bevel or recessed edge is often cut away. For a flush finish, a flush joint with a double trowel width is required unless the recess is re-applied.

When the boards are ready for joint treatments, follow the steps below to obtain the required finish.

a) After the installation of the boards, wait until the moisture content in the sheet is equivalent with that of the ambient atmosphere. This will normally take approximately 24 to 48 hours to achieve. Once equilibrium moisture content is achieved, moisture induced movement will be lower, reducing the risk of joint cracking.

b) Clean the surface of the joint and surrounding area (approximately 300mm in width on each side of joint).

c) Always work with clean tools and containers.

d) The work should be carried out in an environment where the ambient air temperature is at least 5°C or above.

e) Prepare the joint filler as per instructions prescribed by the filler manufacturer. Always use clean water.

f) Fill the joint with sufficient joint filler.

g) Apply a layer of reinforcing fibre mesh tape over the filler and with a spatula cover the complete surface of the tape with an excessive amount of well-embedded joint filler.

h) Allow to dry completely and sand the surface slightly with fine grade sandpaper.

i) Apply a second layer of joint filler with wide trowel.

j) Wait until it is completely cured and sand the surface again slightly with same grade of sandpaper.

k) Depending on the level of finish required, an eventual final layer of joint finisher can be applied with a 280mm wide (preferably curved) trowel.

Normally joint fillers manufactured for use with plasterboards are suitable for flush jointing of Promat boards when installed within dry areas.

If primer is not going to be used, it is recommended that the areas to which the filler will be applied are pre-soaked. This prevents moisture from the filler being absorbed to rapidly into the boards and reduces the risk of cracking and/or delamination of the filler.



Fill joint with single, thin layer of plaster and then overlay reinforcing mesh.



Apply subsequent covering of plaster compound to finish.



Final joint after finishing with trowel.

Finishing

Plastering

PROMATECT® 100 boards have a high suction factor and while successful skim coats are relatively easy to obtain, some care is needed to retard the rapid drying of plaster coats, especially in areas of high temperature.

It is recommended that a small test area is plastered initially to ensure that the boards have been adequately sealed. Use of self-adhesive or hessian scrim applied over joints and internal angles is considerable. Paper scrim is not recommended.

The bonding agent and plaster manufacturer's recommendations must be followed at all times.

Tiling

PROMATECT® 100 boards can be tiled, provided due consideration is given to the installation of the boards and the requirements for additional framing prior to applying the tiles.

It should be noted that all PROMATECT® 100 applications are used for their fire resistance performance. Therefore placing additional weight on an application system, such as ceramic or marble tiling for instance, can have significant effect on the overall fire resistance performance of the system.

As such, additional framing is required for partition systems etc which bear the weight of tiles in order to maintain the fire resistance performance.

As a general rule of thumb, partition systems to be tiled should be constructed with framing at nominal 450mm centres in both vertical and horizontal orientations. Minimum board thickness is applicable.

Care must be taken in sealing the boards thoroughly before applying any tile adhesive as the boards' high suction load will accelerate the setting time of the tile adhesive.



Plastering the board joints in partitions (left) and the junctions of wall and ceiling (above).

Painting

All coatings should be supplied by a reputable manufacturer and their recommendations regarding surface preparation, sealing and finish coating should be followed at all times.

The original smooth surface of PROMATECT® 100 boards can be painted with emulsion or oil based paints after applying with a universal primer. With water based paints, a diluted first coat should be applied. An alkali resisting primer is not required.

Depending on the type of finish required and the viewing circumstances (e.g. under glancing light), some minor surface imperfections of the painting result may occur.

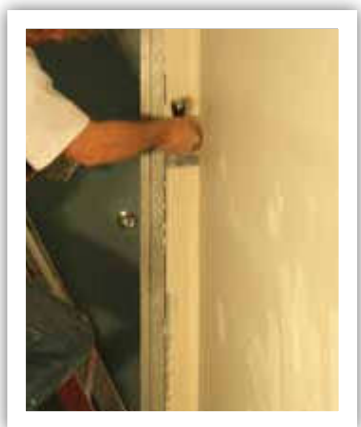

Promat

Structural steel fire protection



Introduction

Numerous research programmes show that some types of fully stressed steel sections can achieve a 30 minute fire resistance without any additional protection materials being applied. However, these apply to a limited number of steel sections only, based on the allowable Section Factor H_p/A . Section Factor is a common term used in fire protection for steelwork and is discussed in detail below.

Typical building regulations usually require certain elements of structure to be fire resistant for more than 30 minutes and up to a specified minimum period of time. The thickness of any fire protection material depends on a number of factors, such as:

- Duration of fire resistance specified
- Type of protection used, e.g. board, paint, spray etc
- Perimeter of the part of steel section exposed to fire
- Shape and dimensions of the steel section

To determine how these various factors affect the fire resistance, all Promat products and systems have been tested at nationally accredited laboratories around the world to a variety of standards, e.g. BS 476: Part 21, AS 1530: Part 4, ASTM E119 and BS EN 13381.

Tests carried out in accordance with the above standards are performed on both loaded and unloaded beams and columns which are clad with fire protection material. Steel surface temperatures are monitored with thermocouples to assess the performance of the cladding. Steel that is fully stressed in accordance with the design guides BS 449 or BS 5950: Part 1 (Australian equivalent AS 4100), begin to lose their design margin of safety at temperatures around 550°C.

The table below shows how the strength of steel reduces as temperatures rise, i.e. variation of effective yield strength factor of normal structural steels with temperature.

Temperature (°C)	20	100	200	300	400	500	600	700	800
Effective yield strength factor	1.00	1.00	1.00	1.00	1.00	0.78	0.47	0.23	0.11

For example, at 700°C, the effective yield strength of Grade 43 (S275) steel is $0.23 \times 275 = 63.25\text{N/mm}^2$.

A range of unloaded sections are also tested to obtain data for analytical calculation, to measure exactly how much protection is needed for the most common steel sections and for providing fire resistance for different time periods.

IMPORTANT: When using Promat protection systems for structural steelwork, conservative limiting temperatures of 550°C and 620°C are referred to for columns and beams respectively and are in general use throughout this brochure. Apart from temperature data, the fire tests also need to demonstrate the ability of cladding to remain in place, usually described as the “stickability” of the material, for the maximum duration for which the protection may be required. The availability of thin materials and the low weight of Promat systems, plus the possibility of prefabrication, ensure maximum cost efficiency.

Section factor (H_p/A)

The degree of fire protection provided depends on the H_p/A Section Factor for the steel section. The H_p/A factor is a function of the area of the steel exposed to the fire and the mass of the steel section. The higher the H_p/A , the faster the steel section heats up and so the greater the thickness of fire protection material required.

It should be noted that in European design standards, the section factor is presented as A/V which has the same numerical value as H_p/A . A/V measures the rate of temperature increase of a steel cross section by the ratio of the heated surface area to the volume. It is likely to gradually replace the use of H_p/A .

Depending on type of material used for protection, the calculation method for H_p/A value may differ. Generally there are two methods of construction for the protection materials: box protection and profile protection.

Box protection using board materials

For box protection, H_p is the sum of the inside dimensions of the smallest possible rectangular or square encasement of the steel section. One exception is circular hollow sections. See page 33.

Where a steel section abuts or is built into a fire resisting wall or floor, the surface in contact with or the surface within the wall or floor is ignored when calculating H_p .

However, the value A is always the total cross sectional area of the whole steel section.

Profile protection using spray/paint materials

Encasements following the profile of the steel section will generally have a higher Hp/A section factor than a box encasement. One exception is circular hollow sections. See page 34.

The serial size and mass per metre of most steel sections are available in tables from steel manufacturers. Sometimes such tables also provide Hp/A values calculated for three or four sided box protection.

Following is an example of a calculation for a steel beam section of 406mm x 178mm x 54kg/m serial size to be encased on 3 sides using box protection method:

Serial size	=	406mm x 178mm
Actual size	=	402.6mm x 177.6mm
Hp	=	B + 2D
	=	177.6 + 2 x 402.6
	=	982.8mm (0.9828m)
A	=	68.4cm ² (0.00684m ²)
Hp/A	=	0.9828 ÷ 0.00684
	=	144.7m ⁻¹
	≈	144m ⁻¹

The value of A, the cross sectional area, can be obtained either from steelwork tables or by accurate measurement. However, if the mass per metre is known then the Hp/A value can be calculated as follows:

$\frac{Hp}{A}$	=	$\frac{7850 \times Hp}{W}$
Where W	=	Mass per metre (kg/m)
Where 7850	=	Nominal density of steel

Sample calculation using the previous example:

$\frac{Hp}{A}$	=	$\frac{7850 \times 0.9828}{54}$
	=	142.87m ⁻¹
	≈	143m ⁻¹

The shape of the steel section can also play an important role when determining the required thickness of a protection material. Following are some notes for reference. For details on steel profiles not outlined here, please consult Promat.

Castellated sections / cellform beams

These steel members heat up more quickly than the original section from which they were produced. Common practice is that protection thickness should therefore be 20% greater than those calculated from the Hp/A value of the original section from which the castellated section is formed.

However, it should be noted that the above information is now superseded by a new, more scientific approach for the protection of castellated sections. The following is taken from "Fire Protection for Structural Steel in Buildings", 4th Edition, published by the ASFP (see www.asfp.org.uk).

The recently amended method of obtaining the section factor (Hp/A) for castellated sections is now specific. In fact, the recommendation from the Steel Construction Institute, published as RT 1085, for castellated sections and cellular beams manufactured from all rolled steel sections and from welded plate, the Section Factor for passive protection system is calculated as:

$$\text{Section factor (m}^{-1}\text{)} = \frac{1400}{t}$$

Where t = the thickness (mm) of the lower steel web and applies for beams made from all steel rolled sections and from welded steel plate.

It should be noted that there are a number of conditions attached to the use of this calculation method, which are detailed in the ASFP "Yellow Book" publication.

Individual protection products, normally quite similar in performance when compared on the basis of rolled steel sections, may require radically different thicknesses for the same cellular beam.

Structural hollow section

The same thickness of board materials can be used on square, rectangular and circular hollow sections as on 'I' sections of the same Hp/A value.

Bracing

Bracing is included in a structure to give resistance to wind forces and provide overall stiffness. Masonry walls and steel cladding contribute to a structure's rigidity but these are rarely taken into account in design. Also, the probability of a major fire occurrence concurrent with maximum wind load is remote (see BS 5950: Part 8). It seems unreasonable therefore to apply the 550°C steel temperature criteria to bracing. While each case must be judged on individual merits, protection to bracing is generally not necessary, but where it is required the Hp/A value of the bracing section or 200m-1 should be used, whichever is the lesser.

Lattice members

As the determination of the protection necessary to protect lattice members requires broad consideration of the lattice design, please consult Promat concerning such steel sections.

Partially exposed members

Where columns or beams are partly built into or are in close contact with walls or floors, the protection afforded to the steelwork by the wall or floor should be taken into account. In those instances where the steel section sits within or against masonry or concrete constructions, this will give protection to the adjacent surface of the steelwork. Thus, for the purpose of determining the heated perimeter (Hp), this should be taken as only that part of the steel section which is exposed. It should be noted that where the steelwork penetrates both sides of a fire resisting construction, e.g. a wall protruding into a space which has an open end, simultaneous attack from fire on both sides may occur on columns partially exposed within the wall. In such an instance, the section factor should be calculated based upon the sum of the areas exposed to fire on either side of the wall and the total volume of the steel section.

Note that separating elements are generally required to offer a performance including the insulation criteria of 140°C or 180°C. Therefore, where a steel section passes through a separating element and is exposed on both sides, consideration must also be given to providing sufficient protection not only to maintain the temperature of the steel section below 550°C but also to ensure the surface temperature on the unexposed face does not exceed the 140°C or 180°C insulation criteria of the separating element. Due allowance for any expected building movement should also be considered.

External lightweight walls

Where the structural elements form portal legs supporting a lightweight external wall, the insulation performance required of the wall may contribute to the protection of any column flange falling within the thickness of the wall. In such cases, please consult Promat to confirm the board thickness and which areas of such columns should be protected.

Internal lightweight partitions/walls

Where a column or beam is built into a fire resistant lightweight wall or partition, the protection to the steelwork can generally be designed on the assumption that only one side of the wall or partition will be exposed to fire at any one time. The wall or partition should be adequately secured to the column in such a way as to ensure the wall or partition will not apply stress on the protection encasement. Due allowance for any expected building movement should be considered.

Floors

Where beams are wholly within the cavity of a timber floor protected by a PROMATECT®-H ceiling, test evidence shows that the cavity air temperature of the floor is such that the beam will be adequately protected to the same fire resistance by the ceiling that protects the floor. Where the beam is wholly or partly below the line of the PROMATECT®-H ceiling then Hp should be based upon the portion of the steel beam that is below ceiling level.

Beams supporting composite floors with profiled metal decking

A series of fire resistance tests has demonstrated that it is not always necessary to fill the void formed between the top flange of a beam and the underside of a profiled steel deck. Recommendations based on the research have been published by the Steel Construction Institute (UK) and for decks running perpendicular to the beams, are as follows:

DOVETAIL DECKS

Voids may be left unfilled for all fire resistance period, unless a fire resisting wall or partition is located beneath the beam.











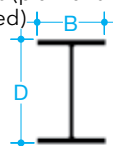





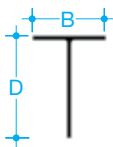



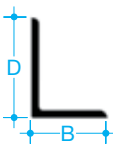

TRAPEZOIDAL DECKS

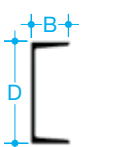
Generally, voids may be left unfilled for up to 60 minutes fire resistance. Also, for 90 minutes if the board thickness used is appropriate for the Hp/A + 15%. Care should be taken to ensure that if the voids are unfilled, the main encasement will need to be adequately secured. For periods over 90 minutes the voids should be filled.

In all instances, voids should also be filled if a fire wall is located beneath the beam, for all fire resistance periods. These recommendations apply to board encasements. The trapezoidal steel deck slab should be designed to act structurally with the beam. If this is not the case, the voids should be filled for all fire resistance periods.

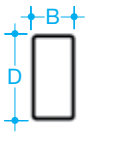
Various box protection

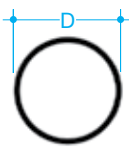
Protection configurations with values of perimeter Hp for use in the calculation of section factor Hp/A (A/V)

Steel section	Box protection				
Universal beams, universal columns and joists (plain and castellated) 	Four sides  $2B + 2D$	Three sides  $B + 2D$	Three sides (partially exposed)  $B + 2d$	Two sides  $B + D$	One side (partially exposed)  B
Structural and rolled tees 	Four sides  $2B + 2D$	Three sides (flange to soffit)  $B + 2D$	Three sides (toe of web to soffit)  $B + 2D$		
Angles 	Four sides  $2B + 2D$	Three sides (flange to soffit)  $B + 2D$	Three sides (toe of flange soffit)  $B + 2D$		
Channels 	Four sides  $2B + 2D$	Three sides (web to soffit)  $2B + D$	Three sides (flange to soffit)  $B + 2D$		
Square or rectangular hollow sections 	Four sides  $2B + 2D$	Three sides  $B + 2D$			
Circular hollow sections 	Four sides  πD	NOTE: The air space created in boxing a circular section improves the insulation and the value of Hp/A. Therefore, Hp higher than profile protection (p) would be anomalous. Hence, Hp is taken as the circumference of the circular section and not 4D.			

Following is an example of calculation for a universal beam section using box protection of 305mm x 305mm x 240kg/m serial size to be encased on three or four sides when $A = 305.6\text{cm}^2$, $B = 317.9\text{mm}$, $D = 352.6\text{mm}$, $t = 23\text{mm}$.

Four sided profile protection:

$$\begin{aligned}
 H_p &= 2B + 2D \\
 &= (2 \times 317.9) + (2 \times 352.6) \\
 &= 1341\text{mm} (1.341\text{m}) \\
 H_p/A &= 1.341 \div 0.03056 \\
 &= 43.9\text{m}^{-1}
 \end{aligned}$$











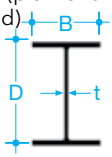

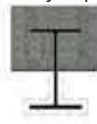

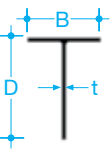



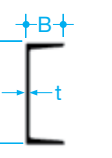

Three sided profile protection:

$$\begin{aligned}
 H_p &= B + 2D \\
 &= 317.9 + (2 \times 352.6) \\
 &= 1023.1\text{mm} (1.023\text{m}) \\
 H_p/A &= 1.023 \div 0.03056 \\
 &= 33.5\text{m}^{-1}
 \end{aligned}$$

The above calculated values are approximate in that radii at corners and roots of all sections are ignored. In these figures, $H_p/A = A/V$.

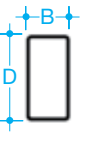
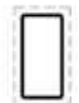
Various profile protection

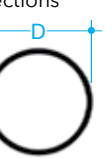
Protection configurations with values of perimeter H_p for use in the calculation of section factor H_p/A (A/V)

Steel section	Profile protection				
Universal beams, universal columns and joists (plain and castellated) 	Four sides  $2B + 2D + 2(B - t)$ $= 4B + 2D - 2t$	Three sides  $B + 2D + 2(B - t)$ $= 3B + 2D - 2t$	Three sides (partially exposed)  $B + 2d + (B - t)$ $= 2B + 2d - t$	Two sides  $B + D + 2(B - t)/2$ $= 2B + D - t$	One side (partially exposed)  B
Structural and rolled tees 	Four sides  $2B + 2D$	Three sides (flange to soffit)  $B + 2D$	Three sides (toe of web to soffit)  $B + 2D + (B - t)$ $= 2B + 2D - t$		
Angles 	Four sides  $2B + 2D$	Three sides (flange to soffit)  $B + 2D$	Three sides (toe of flange soffit)  $B + 2D + (B - t)$ $= 2B + 2D - t$		
Channels 	Four sides  $2B + 2D + 2(B - t)$ $= 4B + 2D - 2t$	Three sides (web to soffit)  $2B + D + 2(B - t)$ $= 4B + D - 2t$	Three sides (flange to soffit)  $B + 2D + 2(B - t)$ $= 3B + 2D - 2t$		
Square or rectangular hollow sections 	Four sides  $2B + 2D$	Three sides  $B + 2D$			
Circular hollow sections 	Four sides  πD				

Following is an example of calculation for a universal beam section using profile protection of 305mm x 305mm x 240kg/m serial size to be encased on three or four sides when $A = 305.6\text{cm}^2$, $B = 317.9\text{mm}$, $D = 352.6\text{mm}$, $t = 23\text{mm}$.

Four sided profile protection:

$$\begin{aligned}
 H_p &= 4B + 2D - 2t \\
 &= (4 \times 317.9) + (2 \times 352.6) - (2 \times 23) \\
 &= 1930.8\text{mm} (1.931\text{m}) \\
 H_p/A &= 1.931 \div 0.03056 \\
 &= 63.1\text{m}^{-1}
 \end{aligned}$$

Three sided profile protection:

$$\begin{aligned}
 H_p &= 3B + 2D - 2t \\
 &= (3 \times 317.9) + (2 \times 352.6) - (2 \times 23) \\
 &= 1612.9\text{mm} (1.613\text{m}) \\
 H_p/A &= 1.613 \div 0.03056 \\
 &= 52.8\text{m}^{-1}
 \end{aligned}$$

The above calculated values are approximate in that radii at corners and roots of all sections are ignored. In these figures, $H_p/A = A/V$.

Universal columns

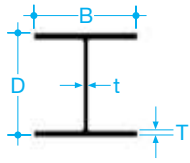

Three sides

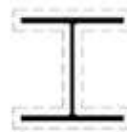

Four sides

Profile protection



Three sides

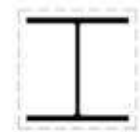

Four sides

Box protection

Designation		Depth of section D (mm)	Width of section B (mm)	Thickness		Area of section (cm ²)	Profile protection		Box protection	
Serial size (mm)	Mass (kg/m)			Web t (mm)	Flange T (mm)		Three sides (m ⁻¹)	Four sides (m ⁻¹)	Three sides (m ⁻¹)	Four sides (m ⁻¹)
356 x 406	634	474.7	424.1	47.6	77.0	808.1	25	30	15	20
	551	455.7	418.5	42.0	67.5	701.8	30	35	20	25
	467	436.6	412.4	35.9	58.0	595.5	35	40	20	30
	393	419.1	407.0	30.6	49.2	500.9	40	45	25	35
	340	406.4	403.0	26.5	42.9	432.7	45	55	30	35
	287	363.7	399.0	22.6	36.5	366.0	50	65	30	45
	235	381.0	395.0	18.5	30.2	299.8	65	75	40	50
356 x 368	202	374.7	374.4	16.8	27.0	257.9	70	85	45	60
	177	368.3	372.1	14.5	23.8	255.7	80	95	50	65
	153	362.0	370.2	12.6	20.7	195.2	90	110	55	75
	129	355.6	368.3	10.7	17.5	164.9	105	130	65	90
305 x 305	283	365.3	321.8	26.9	44.1	360.4	45	55	30	40
	240	352.6	317.9	23.0	37.7	305.6	50	60	35	45
	198	339.9	314.1	19.2	31.4	252.3	60	75	40	50
	158	327.6	310.6	15.7	25.0	201.2	75	90	50	65
	137	320.5	308.7	13.8	21.7	174.6	85	105	55	70
	118	314.5	306.8	11.9	18.7	149.8	100	120	60	85
	97	307.8	304.8	9.9	15.4	123.3	120	145	75	100
254 x 254	167	289.1	264.5	19.2	31.7	212.4	60	75	40	50
	132	276.4	261.0	15.6	25.3	167.7	75	90	50	65
	107	266.7	258.3	13.0	20.5	136.6	90	110	60	75
	89	260.4	255.9	10.5	17.3	114.0	110	130	70	90
	73	254.0	254.0	8.6	14.2	92.9	130	160	80	110
203 x 203	127	241.4	213.9	18.1	30.1	162.0	65	80	45	55
	113	235.0	212.1	16.3	26.9	145.0	75	90	45	60
	100	228.6	210.3	14.5	23.7	127.0	80	100	55	70
	86	222.3	208.8	13.0	20.5	110.1	95	115	60	80
	71	215.9	206.2	10.3	17.3	91.1	110	135	70	95
	60	209.6	205.2	9.3	14.2	75.8	130	160	80	110
	52	206.2	203.9	8.0	12.5	66.4	150	180	95	125
	46	203.2	203.2	7.3	11.0	58.8	170	200	105	140
152 x 152	51	170.2	157.4	11.0	15.7	65.2	120	145	75	100
	44	166.0	155.9	9.5	13.6	56.1	132	165	85	115
	37	161.8	154.4	8.1	11.5	47.4	160	195	100	135
	30	157.5	152.9	6.6	9.4	38.2	195	235	120	160
	23	152.4	152.4	6.1	6.8	29.8	245	305	155	205

Universal beams

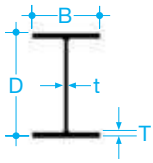

Three sides



Four sides

Profile protection



Three sides



Four sides

Box protection

Designation		Depth of section D (mm)	Width of section B (mm)	Thickness		Area of section (cm ²)	Profile protection		Box protection	
Serial size (mm)	Mass (kg/m)			Web t (mm)	Flange T (mm)		Three sides (m ⁻¹)	Four sides (m ⁻¹)	Three sides (m ⁻¹)	Four sides (m ⁻¹)
1016 x 305	487	1036.1	308.5	30.0	54.1	619.9	45	50	40	45
	438	1025.9	305.4	26.9	49.0	556.6	50	55	40	50
	393	1016.0	303.0	24.4	43.9	500.2	55	65	45	55
	349	1008.1	302.0	21.1	40.0	445.2	65	70	50	60
	314	1000.0	300.0	19.1	35.9	400.4	70	80	55	65
	272	990.1	300.0	16.5	31.0	346.9	80	90	65	75
	249	980.2	300.0	16.5	26.0	316.9	90	95	70	80
914 x 419	388	920.5	420.5	21.5	36.6	494.5	60	70	45	55
	343	911.4	418.5	19.4	32.0	437.5	70	80	50	60
914 x 305	289	926.6	307.8	19.6	32.0	368.8	75	80	60	65
	253	918.5	305.5	17.3	27.9	322.8	85	95	65	75
	224	910.3	304.1	15.9	23.9	285.3	95	105	75	85
	201	903.0	303.4	15.2	20.2	256.4	105	115	80	95
838 x 292	226	850.9	293.8	16.1	26.8	288.7	85	95	70	80
	194	840.7	292.4	14.7	21.7	247.2	100	115	80	90
	176	834.9	291.6	14.0	18.8	224.1	110	125	90	100
762 x 267	197	769.6	268.0	15.6	25.4	250.8	90	100	70	85
	173	762.0	266.7	14.3	21.6	220.5	105	115	80	95
	147	753.9	265.3	12.9	17.5	188.1	120	135	95	110
	134	750.0	264.4	12.0	15.5	170.6	130	145	105	120
686 x 254	170	692.9	255.8	14.5	23.7	216.6	95	110	75	90
	152	687.6	254.5	13.2	21.0	193.8	105	120	85	95
	140	683.5	253.7	12.4	19.0	178.6	115	130	90	105
	125	677.9	253.0	11.7	16.2	159.6	130	145	100	115
610 x 305	238	633.0	311.5	18.6	31.4	303.8	70	80	50	60
	179	617.5	307.0	14.1	23.6	227.9	90	105	70	80
	149	609.6	304.8	11.9	19.7	190.1	110	125	80	95
610 x 229	140	617.0	230.1	13.1	22.1	178.4	105	120	80	95
	125	611.9	229.0	11.9	19.6	159.6	115	130	90	105
	113	607.3	228.2	11.2	17.3	144.5	130	145	100	115
	101	602.2	227.6	10.6	14.8	129.2	140	160	110	130
610 x 178	100	607.4	179.2	11.3	17.2	128.0	135	150	110	125
	92	603.0	178.8	10.9	15.0	117.0	145	160	120	135
	82	598.6	177.9	10.0	12.8	104.0	160	180	130	150
533 x 312	273	577.1	320.2	21.1	37.6	348.0	60	70	40	50
	219	560.3	317.4	18.3	29.2	279.0	70	85	50	65
	182	550.7	314.5	15.2	24.4	231.0	85	100	60	75
	151	542.5	312.0	12.7	20.3	192.0	105	120	75	90
533 x 210	138	549.1	213.9	14.7	23.6	176.0	95	110	75	85
	122	544.6	211.9	12.8	21.3	155.8	110	120	85	95
	109	539.5	210.7	11.6	18.8	138.6	120	135	95	110
	101	536.7	210.1	10.9	17.4	129.3	130	145	100	115
	92	533.1	209.3	10.2	15.6	117.8	140	160	110	125
	82	528.3	208.7	9.6	13.2	104.4	155	175	120	140
533 x 165	85	534.9	166.5	10.3	16.5	108.0	140	155	115	130
	75	529.1	165.9	9.7	13.6	95.2	160	175	130	145
	66	524.7	165.1	8.9	11.4	83.7	180	200	145	165

Continued on opposite page

Universal beams

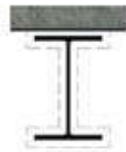
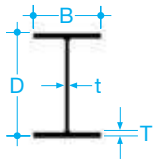

Three sides



Four sides

Profile protection

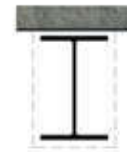

Three sides



Four sides

Box protection

Designation		Depth of section D (mm)	Width of section B (mm)	Thickness		Area of section (cm ²)	Profile protection		Box protection	
Serial size (mm)	Mass (kg/m)			Web t (mm)	Flange T (mm)		Three sides (m ⁻¹)	Four sides (m ⁻¹)	Three sides (m ⁻¹)	Four sides (m ⁻¹)
457 x 191	161	492.0	199.4	18.0	32.0	206.0	75	85	60	65
	133	480.6	196.7	15.3	26.3	170.0	90	100	70	80
	106	469.2	194.0	12.6	20.6	135.0	110	125	85	100
	98	467.4	192.8	11.4	19.6	125.3	120	135	90	105
	89	463.6	192.0	10.6	17.7	113.9	130	145	100	115
	82	460.2	191.3	9.9	16.0	104.5	140	160	105	125
	74	457.2	190.5	9.1	14.5	95.0	150	175	115	135
475 x 152	82	465.1	153.5	10.7	18.9	104.5	130	145	105	120
	74	461.3	152.7	9.9	17.0	95.0	140	155	115	130
	67	457.2	151.9	9.1	15.0	85.4	155	175	125	145
	60	454.7	152.9	8.0	13.3	75.9	175	195	140	160
	52	449.8	152.4	7.6	10.9	66.5	200	220	160	180
406 x 178	85	417.2	181.9	10.9	18.2	109.0	125	140	95	110
	74	412.8	179.7	9.7	16.0	95.0	140	160	105	125
	67	409.4	178.8	8.8	14.3	85.5	155	175	115	140
	60	406.4	177.8	7.8	12.8	76.0	175	195	130	155
	54	402.6	177.6	7.6	10.9	68.4	190	215	145	170
406 x 140	53	406.6	143.3	7.9	12.9	67.9	180	200	140	160
	46	402.3	142.4	6.9	11.2	59.0	205	230	160	185
	39	397.3	141.8	6.3	8.6	49.4	240	270	190	220
356 x 171	67	364.0	173.2	9.1	15.7	85.4	140	160	105	125
	57	358.6	172.1	8.0	13.0	72.2	165	190	125	145
	51	355.6	171.5	7.3	11.5	64.6	185	210	135	165
	45	352.0	171.0	6.9	9.7	57.0	210	240	155	185
356 x 127	39	352.8	126.0	6.5	10.7	49.4	215	240	170	195
	33	348.5	125.4	5.9	8.5	41.8	250	280	195	225
305 x 165	54	310.9	166.8	7.7	13.7	68.4	160	185	115	140
	46	307.1	165.7	6.7	11.8	58.9	185	210	130	160
	40	303.8	165.1	6.1	10.2	51.5	210	240	150	180
305 x 127	48	310.4	125.2	8.9	14.0	60.8	160	180	125	145
	42	306.6	124.3	8.0	12.1	53.2	180	200	140	160
	37	303.8	123.5	7.2	10.7	47.5	200	225	155	180
305 x 102	33	312.7	102.4	6.6	10.8	41.8	215	240	175	200
	28	308.9	101.9	6.1	8.9	36.3	245	275	200	225
	25	304.8	101.6	5.8	6.8	31.4	285	315	255	260
254 x 146	43	259.6	147.3	7.3	12.7	55.1	170	195	120	150
	37	256.0	146.4	6.4	10.9	47.5	195	225	140	170
	31	251.5	146.1	6.1	8.6	40.0	230	265	160	200
254 x 102	28	260.4	102.1	6.4	10.0	36.2	220	250	170	200
	25	257.0	101.9	6.1	8.4	32.2	245	280	190	220
	22	254.0	101.6	5.8	6.8	28.4	275	315	215	250
203 x 133	30	206.8	133.8	6.3	9.6	38.0	210	245	143	180
	25	203.2	133.4	5.8	7.8	32.3	240	285	165	210
203 x 102	23	203.2	101.8	5.4	9.3	29.4	235	270	175	205
178 x 102	19	177.8	101.2	4.8	7.9	24.3	260	305	190	230
152 x 89	16	152.4	88.7	4.5	7.7	20.3	270	315	195	235
127 x 76	13	127.0	76.0	4.0	7.6	16.5	280	326	200	245

Joists

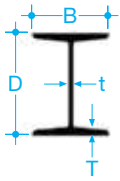

Three sides



Four sides

Profile protection



Three sides

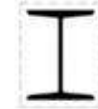

Four sides

Box protection

Designation		Depth of section D (mm)	Width of section B (mm)	Thickness		Area of section (cm ²)	Profile protection		Box protection	
Serial size (mm)	Mass (kg/m)			Web t (mm)	Flange T (mm)		Three sides (m ⁻¹)	Four sides (m ⁻¹)	Three sides (m ⁻¹)	Four sides (m ⁻¹)
254 x 203	81.9	254.0	203.2	10.2	19.9	104.4	95	115	70	90
254 x 114	37.2	254.0	114.3	7.6	12.8	47.4	165	190	130	155
203 x 152	52.1	203.2	152.4	8.9	16.5	66.4	115	140	85	105
203 x 102	25.3	203.2	101.6	5.8	10.4	32.3	205	235	155	190
178 x 102	21.5	177.8	101.6	5.3	9.0	27.4	225	260	165	205
152 x 127	37.2	152.4	127.0	10.4	13.2	47.5	130	155	90	120
152 x 89	17.1	152.4	88.9	4.9	8.3	21.8	245	285	180	220
152 x 76.8	17.9	152.4	76.2	5.8	9.6	22.8	215	245	165	200
127 x 114	29.8	127.0	114.3	10.2	11.5	37.3	140	175	100	130
127 x 114	26.8	127.0	114.3	7.4	11.4	34.1	155	190	110	140
127 x 76	16.4	127.0	76.2	5.6	9.6	21.0	205	245	155	195
127 x 76	13.4	127.0	76.2	4.5	7.6	17.0	265	310	195	240
114 x 114	26.8	114.3	114.3	9.5	10.7	34.4	145	180	100	135
102 x 102	23.1	101.6	101.6	9.5	10.3	29.4	150	185	105	140
102 x 64	9.7	101.6	63.5	4.1	6.6	12.3	295	345	215	270
102 x 44	7.4	101.6	44.4	4.3	6.1	9.5	320	365	260	305
89 x 89	19.4	88.9	88.6	9.5	9.9	24.9	155	190	105	145
76 x 76	14.7	76.2	80.0	8.9	8.4	19.1	175	220	120	165
76 x 76	12.7	76.2	76.2	5.1	8.4	16.3	205	250	140	185

Channels

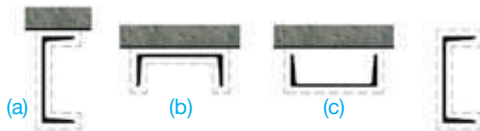
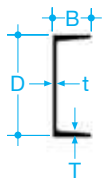

Examples of three sides

Four sides

Profile protection

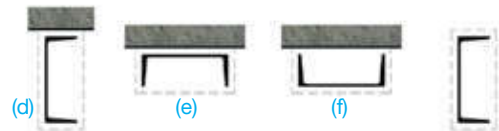

Examples of three sides

Four sides

Box protection

Designation		Depth of section D (mm)	Width of section B (mm)	Thickness		Area of section (cm ²)	Profile protection				Box protection			
Serial size (mm)	Mass (kg/m)			Web t (mm)	Flange T (mm)		(a) Three sides (m ⁻¹)	(b) Three sides (m ⁻¹)	(c) Three sides (m ⁻¹)	Four sides (m ⁻¹)	(d) Three sides (m ⁻¹)	(e) Three sides (m ⁻¹)	(f) Three sides (m ⁻¹)	Four sides (m ⁻¹)
430 x 100	64.4	430	100	11.0	19.0	82.1	135	95	75	150	115	75	75	130
380 x 100	54.0	380	100	9.5	17.5	68.7	150	110	85	165	125	85	85	140
300 x 100	45.5	300	100	9.0	16.5	58.0	150	115	85	165	120	85	85	140
300 x 90	41.4	300	90	9.0	15.5	52.8	160	120	90	175	130	90	90	150
260 x 90	34.8	260	90	8.0	14.0	44.4	170	135	100	190	135	100	100	160
260 x 75	27.6	260	75	7.0	12.0	35.1	205	150	115	225	170	115	115	190
230 x 90	32.2	230	90	7.5	14.0	41.0	170	140	100	195	135	100	100	155
230 x 75	25.7	230	75	6.5	12.5	32.7	200	155	115	225	165	115	115	185
200 x 90	29.7	200	90	7.0	14.0	37.9	170	140	100	195	130	100	100	155
200 x 75	23.4	200	75	6.0	12.5	29.9	200	160	115	225	160	115	115	185
180 x 90	26.1	180	90	6.5	12.5	33.2	185	155	110	210	135	110	110	165
180 x 75	20.3	180	75	6.0	10.5	25.9	215	175	125	245	170	125	125	195
150 x 90	23.9	150	90	6.5	12.0	30.4	180	160	110	210	130	110	110	160
150 x 75	17.9	150	75	5.5	10.0	22.8	220	190	130	255	165	130	130	200
125 x 65	14.8	125	65	5.5	9.5	18.8	225	195	135	260	170	135	135	200
100 x 50	10.2	100	50	5.0	8.5	13.0	225	215	155	295	190	155	155	230

Equal angles

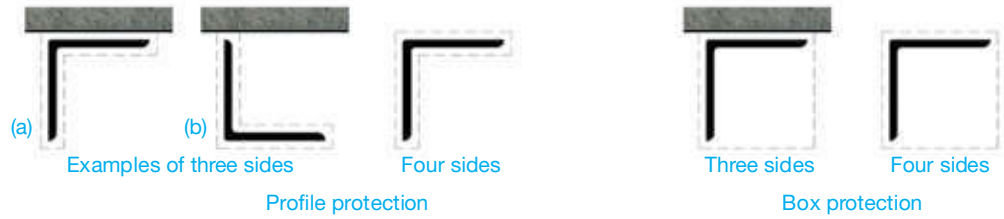
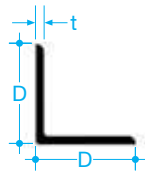

Designation		Thickness t (mm)	Area of section (cm ²)	Profile protection			Box protection	
Size D x D (mm)	Mass (kg/m)			(a) Three sides (m ¹)	(b) Three sides (m ¹)	Four sides (m ¹)	Three sides (m ¹)	Four sides (m ¹)
200 x 200	71.1	24	90.6	65	85	85	65	90
	59.9	20	76.3	75	100	105	80	105
	54.2	18	69.1	85	110	115	85	115
	48.5	16	61.8	95	125	125	95	130
150 x 150	40.1	18	51.0	85	110	115	90	115
	33.8	15	43.0	100	135	135	105	140
	27.3	12	34.8	125	165	170	130	170
	23.0	10	29.3	150	200	200	155	205
120 x 120	26.6	15	33.9	105	135	140	105	140
	21.6	12	27.5	125	170	170	130	175
	18.2	10	23.2	150	200	200	155	205
	14.7	8	18.7	185	250	250	190	255
100 x 100	21.9	15	27.9	105	135	140	105	145
	17.8	12	22.7	130	170	170	130	175
	15.0	10	19.2	150	200	205	155	210
	12.2	8	15.5	185	250	250	195	260
90 x 90	15.9	12	20.3	130	170	175	135	175
	13.4	10	17.1	150	200	205	155	210
	10.9	8	13.9	190	245	250	195	260
	9.6	7	12.2	215	280	285	220	295
80 x 80	11.9	10	15.1	155	205	205	160	210
	9.6	8	12.3	190	250	255	195	260
	7.3	6	9.4	250	330	335	255	340
70 x 70	10.3	10	13.1	155	205	210	160	215
	8.4	8	10.6	190	250	255	195	260
	6.4	6	8.1	250	330	335	255	340
60 x 60	8.7	10	11.1	155	205	210	160	215
	7.1	8	9.0	190	250	260	200	265
	5.4	6	6.9	250	330	335	260	345
	4.6	5	5.8	300	395	400	305	410
50 x 50	5.8	8	7.4	195	255	260	200	270
	4.5	6	5.7	255	335	340	260	350
	3.8	5	4.8	300	400	405	310	415
45 x 45	4.0	6	5.1	255	335	340	265	350
	3.4	5	4.3	300	400	405	310	415
	2.7	4	3.5	370	490	495	385	510
40 x 40	3.5	6	4.5	255	340	345	265	355
	3.0	5	3.8	305	400	410	315	420
	2.4	4	3.1	375	495	500	390	515
25 x 25	1.8	5	2.3	315	415	430	335	445
	1.5	4	1.9	390	515	525	405	545
	1.1	3	1.4	505	680	685	530	710

Unequal angles

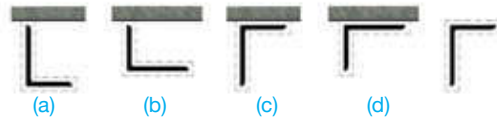
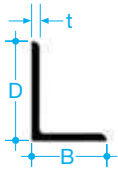

Examples of three sides Four sides
Profile protection

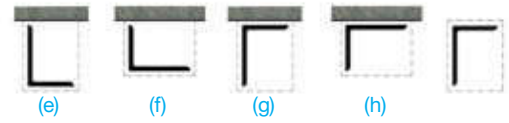

Examples of three sides Four sides
Box protection

Designation		Thickness t (mm)	Area of section (cm ²)	Profile protection					Box protection				
Size D x B (mm)	Mass (kg/m)			(a) Three sides (m ²)	(b) Three sides (m ²)	(c) Three sides (m ²)	(d) Three sides (m ²)	Four sides (m ²)	(e) Three sides (m ²)	(f) Three sides (m ²)	(g) Three sides (m ²)	(f) Three sides (m ²)	Four sides (m ²)
200 x 150	47.1	18	60.0	110	110	90	80	115	90	85	90	85	115
	39.6	15	50.5	135	135	105	95	135	110	100	110	100	140
	32.0	12	40.8	165	165	130	120	170	135	120	135	120	170
200 x 100	33.7	15	43.0	135	135	115	90	135	115	95	115	95	140
	27.3	12	34.8	165	165	140	110	170	145	115	145	115	170
	23.0	10	29.2	195	195	165	135	200	170	135	170	135	205
150 x 90	26.6	15	33.9	135	135	110	95	140	115	95	115	95	140
	21.6	12	27.5	165	165	140	115	170	140	120	140	120	175
	18.2	10	23.2	200	200	165	140	205	170	140	170	140	205
150 x 75	24.8	15	31.6	135	135	115	90	140	120	95	120	95	140
	20.2	12	25.7	165	165	140	115	170	145	115	145	115	175
	17.0	10	21.6	200	200	170	135	205	175	140	175	140	210
125 x 75	17.8	12	22.7	165	165	140	115	170	145	120	145	120	175
	15.0	10	19.1	200	200	165	140	205	170	145	170	145	210
	12.2	8	15.5	245	245	205	170	250	210	175	210	175	260
100 x 75	15.4	12	19.7	170	170	135	125	175	140	125	140	125	180
	13.0	10	16.6	200	200	160	145	205	165	150	165	150	210
	10.6	8	13.5	250	250	200	180	255	205	185	205	185	260
100 x 65	12.3	10	15.6	200	200	165	140	205	170	145	170	145	210
	9.9	8	12.7	245	245	200	175	255	210	180	210	180	260
	8.8	7	11.2	280	280	230	200	290	235	205	235	205	295
80 x 60	8.3	8	10.6	250	250	200	180	255	210	190	210	190	265
	7.4	7	9.4	285	285	225	205	290	235	215	235	215	300
	6.4	6	8.1	330	330	265	240	335	270	250	270	250	345
75 x 50	7.4	8	9.4	250	250	205	180	260	210	185	210	185	265
	5.7	6	7.2	330	330	270	235	340	275	240	275	240	345
65 x 50	6.8	8	8.6	250	250	205	185	260	210	190	210	190	265
	5.2	6	6.6	335	335	265	245	340	275	250	275	250	350
	4.4	5	5.5	395	395	315	290	405	325	295	325	295	415

Structural tees of universal columns

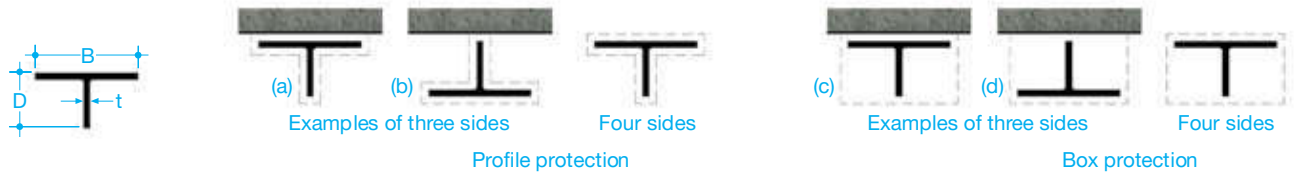

Designation		Depth of section D (mm)	Width of section B (mm)	Thickness t (mm)	Area of section (cm ²)	Profile protection			Box protection		
Serial size (mm)	Mass (kg/m)					(a) Three sides (m ⁻¹)	(b) Three sides (m ⁻¹)	Four sides (m ⁻¹)	(c) Three sides (m ⁻¹)	(d) Three sides (m ⁻¹)	Four sides (m ⁻¹)
406 x 178	118	190.5	395.0	18.5	149.9	50	75	75	50	50	80
368 x 178	101	187.3	374.4	16.8	129.0	55	85	85	60	60	85
	89	184.2	372.1	14.5	112.9	65	95	95	65	65	100
	77	181.0	370.2	12.6	97.6	75	110	110	75	75	115
	65	177.8	368.3	10.7	82.5	85	130	130	90	90	130
305 x 152	79	163.6	310.6	15.7	100.6	60	90	95	65	65	95
	69	160.3	308.7	13.8	87.3	70	105	105	70	70	110
	59	157.2	306.8	11.9	74.9	80	120	120	85	85	125
254 x 127	49	153.9	304.8	9.9	61.6	95	145	145	100	100	150
	84	144.5	265.2	19.2	106.0	50	75	75	50	50	75
	66	138.2	261.0	15.6	84.5	65	90	95	65	65	95
	54	133.4	258.3	13.0	68.3	75	110	115	75	75	115
	45	130.2	255.9	10.5	57.0	90	130	135	90	90	135
203 x 102	37	127.0	254.0	8.6	46.4	105	160	160	110	110	165
	64	120.7	213.9	18.1	81.2	55	80	80	55	55	80
	57	117.5	212.1	16.3	72.3	60	90	90	60	60	90
	50	114.3	210.3	14.5	63.4	70	100	100	70	70	100
	43	111.1	208.8	13.0	55.0	75	110	115	80	80	115
	36	108.0	206.2	10.3	45.5	90	135	135	95	95	140
	30	104.8	205.2	9.3	37.9	105	160	160	110	110	165
	26	103.1	203.9	8.0	33.2	120	180	180	125	125	185
152 x 76	23	101.6	203.2	7.3	29.4	135	200	205	140	140	205
	26	85.1	157.4	11.0	32.6	100	145	145	100	100	150
	22	83.0	155.9	9.5	28.0	110	165	170	115	115	170
	19	80.9	154.4	8.1	23.7	130	195	195	135	135	200
	15	78.7	152.9	6.6	19.1	160	235	240	160	160	240
12	76.2	152.4	6.1	14.9	200	300	305	205	205	310	

Structural tees of universal beams

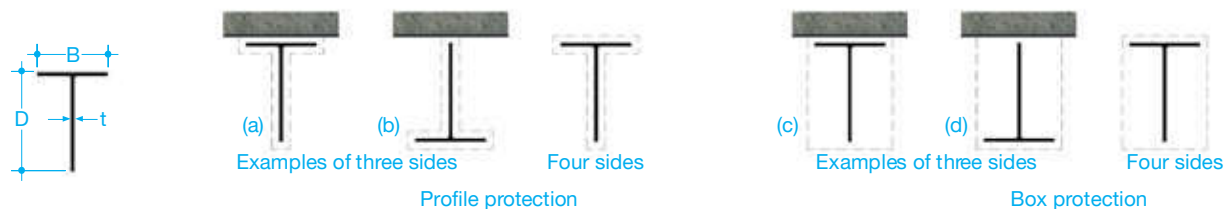

Designation		Depth of section D (mm)	Width of section B (mm)	Web thickness t (mm)	Area of section (cm ²)	Profile protection			Box protection		
Serial size (mm)	Mass (kg/m)					(a) Three sides (m ⁻¹)	(b) Three sides (m ⁻¹)	Four sides (m ⁻¹)	(c) Three sides (m ⁻¹)	(d) Three sides (m ⁻¹)	Four sides (m ⁻¹)
305 x 457	127	459.2	305.5	17.3	161.4	75	95	95	75	75	95
	112	455.2	304.1	15.9	142.6	85	105	105	85	85	105
	101	451.5	303.4	15.2	128.2	95	115	115	95	95	120
292 x 419	113	425.5	293.8	16.1	144.4	80	100	100	80	80	100
	97	420.4	292.4	14.7	123.6	90	115	115	90	90	115
	88	417.4	291.6	14.0	112.1	100	125	125	100	100	125

Structural tees of universal beams

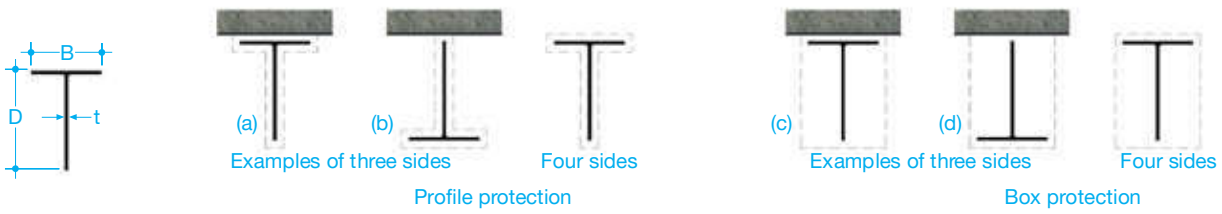

Designation		Depth of section D (mm)	Width of section B (mm)	Web thickness t (mm)	Area of section (cm ²)	Profile protection			Box protection		
Serial size (mm)	Mass (kg/m)					(a) Three sides (m ⁻¹)	(b) Three sides (m ⁻¹)	Four sides (m ⁻¹)	(c) Three sides (m ⁻¹)	(d) Three sides (m ⁻¹)	Four sides (m ⁻¹)
267 x 381	99	384.8	268.0	15.6	125.4	80	100	105	85	85	105
	87	381.0	266.7	14.3	110.2	90	115	115	90	90	120
	74	376.9	265.3	12.9	94.0	105	135	135	110	110	135
254 x 343	85	346.5	255.8	14.5	108.3	85	10	110	90	90	110
	76	343.8	254.5	13.2	96.9	95	120	120	95	95	125
	70	341.8	253.7	12.4	89.3	105	130	130	105	105	135
305 x 305	63	339.0	253.0	11.7	79.8	115	145	145	115	115	150
	119	316.5	311.8	18.6	151.9	60	80	80	60	60	85
	90	308.7	307.0	14.1	114.0	80	105	102	80	80	110
229 x 305	75	304.8	304.8	11.9	95.1	95	125	125	95	95	130
	70	308.5	230.1	13.1	89.2	95	120	120	95	95	120
	63	305.9	229.0	11.9	79.8	105	130	135	105	105	135
210 x 267	57	303.7	228.2	11.2	72.2	115	145	145	115	115	145
	51	301.1	227.6	10.6	64.6	125	160	160	130	130	165
	61	272.3	211.9	12.8	77.9	95	120	125	95	95	125
	55	269.7	210.7	11.6	69.3	105	135	135	110	110	140
	51	268.4	210.1	10.9	64.6	115	145	145	115	115	150
165 x 267	46	266.6	209.3	10.2	58.9	125	160	160	125	125	160
	41	264.2	208.7	9.6	52.2	140	175	180	140	140	180
	42	267.1	166.5	10.3	54.0	130	155	160	130	130	160
	37	264.5	165.9	9.7	47.6	145	175	180	145	145	180
191 x 229	33	262.4	165.1	8.9	41.9	160	200	200	165	165	205
	81	246.0	199.4	18.0	103.0	65	85	85	65	65	85
	67	240.3	196.7	15.3	84.9	80	100	100	80	80	105
	53	234.6	194.0	12.6	67.4	95	125	125	100	100	125
	49	233.7	192.8	11.4	62.6	105	135	135	105	105	135
	45	231.8	192.0	10.6	57.0	115	145	145	115	115	150
	41	230.1	191.3	9.9	52.3	125	160	160	125	125	160
	37	228.6	190.5	9.1	47.5	135	175	180	135	135	175
152 x 229	34	226.8	189.9	8.5	42.7	150	135	135	150	150	195
	41	232.5	153.5	10.7	52.2	115	145	145	120	120	150
	37	230.6	152.7	9.9	47.5	125	155	160	130	130	160
	34	228.6	151.9	9.1	42.7	140	175	175	145	145	180
	30	227.3	152.9	8.0	38.0	150	190	195	160	160	200
178 x 203	26	224.9	152.4	7.6	33.2	180	220	225	180	180	225
	43	208.6	181.9	10.9	54.3	110	140	140	110	110	145
	37	206.4	179.7	9.7	47.5	120	160	160	125	125	160
	34	204.7	178.8	8.8	42.7	135	175	175	140	140	180
	30	203.2	177.8	7.8	38.0	150	195	200	155	155	200
140 x 203	27	201.3	177.6	7.6	34.2	165	215	220	170	170	220
	27	203.3	143.3	7.9	34.0	160	200	200	160	160	205
	23	201.2	142.4	6.9	29.5	180	230	230	185	185	235
	20	198.6	141.8	6.3	24.7	215	270	275	220	220	275

Continued on opposite page

Structural tees of universal beams

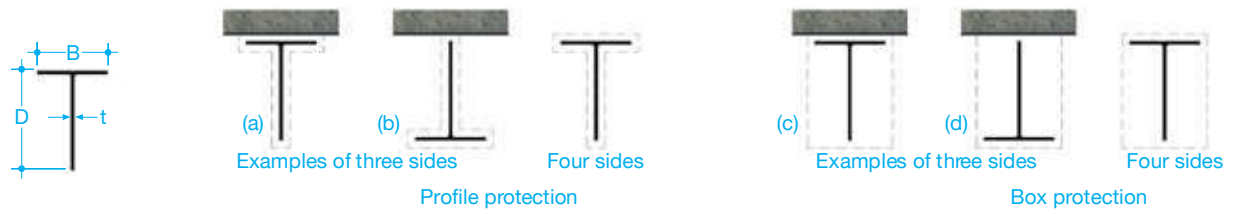

Designation		Depth of section D (mm)	Width of section B (mm)	Web thickness t (mm)	Area of section (cm ²)	Profile protection			Box protection		
Serial size (mm)	Mass (kg/m)					(a) Three sides (m ⁻¹)	(b) Three sides (m ⁻¹)	Four sides (m ⁻¹)	(c) Three sides (m ⁻¹)	(d) Three sides (m ⁻¹)	Four sides (m ⁻¹)
171 x 178	34	182.0	173.2	9.1	42.7	125	160	165	125	125	165
	29	179.3	172.1	8.0	36.1	145	190	190	145	145	195
	26	177.8	171.5	7.3	32.3	160	210	215	165	165	215
	23	176.0	171.0	6.9	28.5	180	240	240	185	185	245
127 x 178	20	176.4	126.0	6.5	24.7	190	240	240	195	195	245
	17	174.2	125.4	5.9	20.9	225	280	285	225	225	285
165 x 152	27	155.4	166.8	7.7	34.2	140	185	185	140	140	190
	23	153.5	165.7	6.7	29.5	160	210	215	160	160	215
	20	151.9	165.1	6.1	25.8	180	240	245	180	180	245
127 x 152	24	155.2	125.2	8.9	30.4	140	180	180	145	145	185
	21	153.3	124.3	8.0	26.6	160	200	205	160	160	210
	19	151.9	123.5	7.2	23.7	175	225	230	180	180	230
102 x 152	17	156.3	102.4	6.6	20.9	195	240	245	200	200	245
	14	154.5	101.9	6.1	18.2	220	275	280	225	225	280
	13	152.4	101.6	5.8	15.7	255	320	320	260	260	325
146 x 127	22	129.8	147.3	7.3	27.6	145	195	200	150	150	200
	19	128.0	146.4	6.4	23.7	165	225	230	170	170	230
	16	125.7	146.1	6.1	20.0	195	265	270	200	200	270
102 x 127	14	130.2	102.1	6.4	18.1	195	250	250	200	200	255
	13	128.5	101.9	6.1	16.1	220	280	280	220	220	285
	11	127.0	101.6	5.8	14.2	245	315	320	250	250	325
133 x 102	15	103.4	133.8	6.3	19.0	175	245	245	180	180	250
	13	101.6	133.4	5.8	16.1	205	285	290	210	210	290

Rolled tees

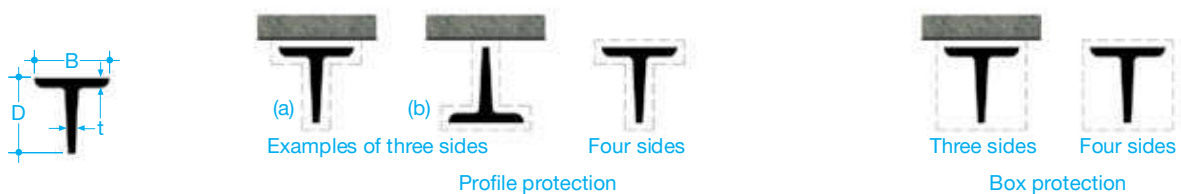

Designation		Depth of section D (mm)	Width of section B (mm)	Thickness t (mm)	Area of section (cm ²)	Profile protection			Box protection	
Serial size (mm)	Mass (kg/m)					(a) Three sides (m ⁻¹)	(b) Three sides (m ⁻¹)	Four sides (m ⁻¹)	Three sides (m ⁻¹)	Four sides (m ⁻¹)
51 x 51	6.9	50.8	50.8	9.5	8.8	175	220	230	175	230
	4.8	50.8	50.8	6.4	6.1	250	325	335	250	335
44 x 44	4.1	44.4	44.4	6.4	5.2	255	325	340	255	340
	3.1	44.4	44.4	4.8	4.0	335	430	445	335	445

Square hollow sections

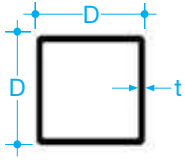

Three sides

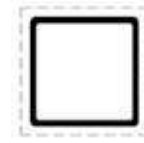

Four sides

Profile or box protection

Designation		Thickness t (mm)	Area of section (cm ²)	Profile or box protection	
Size D x D (mm)	Mass (kg/m)			Three sides (m ⁻¹)	Four sides (m ⁻¹)
20 x 20	1.1	2.0	1.4	425	565
	1.4	2.5	1.7	350	465
25 x 25	1.4	2.0	1.8	410	550
	1.7	2.5	2.2	340	450
	2.0	3.0	2.6	290	385
	2.2	3.2	2.7	275	365
30 x 30	2.1	2.5	2.7	330	440
	2.5	3.0	3.2	280	375
	2.6	3.2	3.4	265	355
40 x 40	2.9	2.5	3.7	325	430
	3.5	3.0	4.4	275	365
	3.7	3.2	4.7	260	345
	4.0	3.6	5.1	235	315
	4.5	4.0	5.7	210	280
50 x 50	5.4	5.0	6.9	175	235
	3.7	2.5	4.7	320	425
	4.4	3.0	5.6	270	355
	4.7	3.2	5.9	255	335
	5.1	3.6	6.5	230	305
	5.7	4.0	7.3	205	275
60 x 60	7.0	5.0	8.9	170	225
	8.5	6.3	10.8	140	185
	5.4	3.0	6.8	265	355
	5.7	3.2	7.2	250	330
	6.3	3.6	8.0	225	300
	7.0	4.0	8.9	205	270
	8.5	5.0	10.9	165	220
	10.5	6.3	13.3	135	180
70 x 70	12.8	8.0	16.3	110	145
	6.3	3.0	8.0	260	350
	6.6	3.2	8.4	250	335
	7.5	3.6	9.5	220	295
	8.2	4.0	10.4	205	270
	10.1	5.0	12.9	165	215
80 x 80	12.5	6.3	15.9	130	175
	15.3	8.0	19.5	110	145
	7.2	3.0	9.2	260	350
	7.6	3.2	9.7	250	330
	8.6	3.6	10.9	220	295
	9.4	4.0	12.0	200	270
	11.7	5.0	14.9	160	215
90 x 90	14.4	6.3	18.4	130	175
	17.8	8.0	22.7	105	140
	9.7	3.6	12.4	220	290
	10.7	4.0	13.6	200	265
	13.3	5.0	16.9	160	215
100 x 100	16.4	6.3	20.9	130	170
	20.4	8.0	25.9	105	140
	10.8	3.6	13.7	220	295
	12.0	4.0	15.3	195	260
	14.8	5.0	18.9	160	210
	18.4	6.3	23.4	130	170
120 x 120	22.9	8.0	29.1	105	135
	27.9	10.0	35.5	85	115
	14.4	4.0	18.4	195	260
	18.0	5.0	22.9	155	210
	22.3	6.3	28.5	125	170
	27.9	8.0	35.5	100	135
	34.2	10.0	43.5	85	110
41.6	12.5	53.0	70	90	

Designation		Thickness t (mm)	Area of section (cm ²)	Profile or box protection	
Size D x D (mm)	Mass (kg/m)			Three sides (m ⁻¹)	Four sides (m ⁻¹)
140 x 140	21.1	5.0	26.9	155	210
	26.3	6.3	33.5	125	165
	32.9	8.0	41.9	100	135
	40.4	10.0	51.5	80	110
	49.5	12.5	63.0	65	90
150 x 150	22.7	5.0	28.9	155	210
	28.3	6.3	36.0	125	165
	35.4	8.0	45.1	100	135
	43.6	10.0	55.5	80	110
	53.4	12.5	68.0	65	90
160 x 160	66.4	16.0	84.5	55	70
	24.1	5.0	30.7	160	210
	30.1	6.3	38.3	125	170
	37.6	8.0	48.0	100	135
	46.3	10.0	58.9	85	110
180 x 180	56.6	12.5	72.1	70	90
	63.3	14.2	80.7	60	80
	70.2	16.0	89.4	55	75
	27.3	5.0	34.7	155	210
	34.2	6.3	43.6	125	165
200 x 200	43.0	8.0	54.7	100	130
	53.0	10.0	67.5	80	105
	65.2	12.5	83.0	65	85
	72.2	14.2	92.0	60	80
	81.4	16.0	104.0	50	70
250 x 250	30.4	5.0	38.7	155	210
	38.2	6.3	48.6	125	165
	48.0	8.0	61.1	100	130
	59.3	10.0	75.5	80	105
	73.0	12.5	93.0	65	85
260 x 260	81.1	14.2	103.0	60	80
	91.5	16.0	117.0	50	70
	48.1	6.3	61.2	125	165
	60.5	8.0	77.1	95	130
	75.0	10.0	95.5	80	105
300 x 300	92.6	12.5	118.0	65	85
	117.0	16.0	149.0	50	65
	49.9	6.3	63.5	125	165
	62.8	8.0	80.0	100	130
	77.7	10.0	98.9	80	105
350 x 350	95.8	12.5	122.0	65	85
	108.0	14.2	137.0	60	75
	120.0	16.0	153.0	55	70
	57.8	6.3	73.6	125	165
	72.8	8.0	92.8	100	130
400 x 400	90.7	10.0	116.0	80	105
	112.0	12.5	143.0	65	85
	126.0	14.2	160.0	60	75
	142.0	16.0	181.0	50	65
	85.4	8.0	109.0	100	130
400 x 400	106.0	10.0	135.0	75	105
	132.0	12.5	168.0	60	85
	148.0	14.2	189.0	55	75
	167.0	16.0	213.0	50	65
	97.9	8.0	125.0	100	130
	122.0	10.0	156.0	75	105
	152.0	12.5	193.0	60	85
170.0	14.2	217.0	55	75	
192.0	16.0	245.0	50	65	
235.0	20.0	300.0	40	55	

Rectangular hollow sections

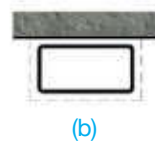
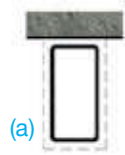
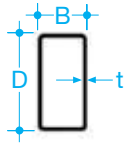

(a)

(b)

Examples of three sides

Four sides

Profile or box protection

Designation		Thickness t (mm)	Area of section (cm ²)	Profile or box protection		
Size D x B (mm)	Mass (kg/m)			(a) Three sides (m ¹)	(b) Three sides (m ¹)	Four sides (m ¹)
50 x 50	2.7	2.5	3.5	360	290	430
	3.2	3.0	4.1	305	245	365
	3.4	3.2	4.3	290	230	345
50 x 30	2.9	2.5	3.7	350	295	430
	3.5	3.0	4.4	290	250	365
	3.7	3.2	4.7	280	235	345
	4.0	3.6	5.1	255	215	315
	4.5	4.0	5.7	230	195	280
	5.4	5.0	6.9	190	160	235
	3.7	2.5	4.7	340	295	425
60 x 40	4.4	3.0	5.6	285	250	355
	4.7	3.2	5.9	270	235	335
	5.1	3.6	6.5	245	215	305
	5.7	4.0	7.3	220	190	275
	7.0	5.0	8.9	180	160	225
	8.5	6.3	10.8	150	130	185
	5.3	3.0	6.8	295	235	355
80 x 40	5.7	3.2	7.2	275	220	330
	6.3	3.6	8.0	250	200	300
	7.0	4.0	8.9	225	180	270
	8.5	5.0	10.9	185	145	220
	10.5	6.3	13.3	150	120	180
	12.8	8.0	16.3	125	100	145
	6.3	3.0	8.0	290	240	350
90 x 50	6.6	3.2	8.4	275	225	335
	7.5	3.6	9.5	240	200	295
	8.2	4.0	10.4	225	185	270
	10.1	5.0	12.9	180	145	215
	12.5	6.3	15.9	145	120	175
	15.3	8.0	19.5	120	95	145
	6.8	3.0	8.6	290	235	350
100 x 50	7.2	3.2	9.1	275	220	330
	8.0	3.6	10.1	250	200	300
	8.9	4.0	11.3	220	175	265
	10.9	5.0	13.9	180	145	215
	13.4	6.3	17.1	145	115	175
	16.6	8.0	21.1	120	95	145
	7.2	3.0	9.2	285	240	350
100 x 60	7.6	3.2	9.7	270	230	330
	8.6	3.6	10.9	240	200	295
	9.4	4.0	12.0	220	185	270
	11.7	5.0	14.9	175	150	215
	14.4	6.3	18.4	140	120	175
	17.8	8.0	22.7	115	95	140
	9.7	3.6	12.4	240	195	290
120 x 60	10.7	4.0	13.6	220	180	265
	13.3	5.0	16.9	180	140	215
	16.4	6.3	20.9	145	115	170
	20.4	8.0	25.9	115	95	140
	24.3	10.0	30.9	100	80	120
	10.8	3.6	13.7	235	205	295
	120 x 80	11.9	4.0	15.2	210	185
14.8		5.0	18.9	170	150	210
18.4		6.3	23.4	135	120	170
22.9		8.0	29.1	110	95	135
27.9		10.0	35.5	90	80	115
15.1		4.0	19.2	210	185	260
150 x 100		18.7	5.0	23.9	165	145
	23.3	6.3	29.7	135	120	170
	29.1	8.0	37.1	110	95	135
	35.7	10.0	45.5	90	75	110
	43.6	12.5	55.5	70	65	90
	16.6	4.0	21.2	200	190	260
	150 x 125	20.6	5.0	26.2	165	155
25.6		6.3	32.6	130	125	170
32.0		8.0	40.8	105	100	135
39.2		10.0	49.9	85	80	110
47.7		12.5	60.8	70	70	90

Rectangular hollow sections

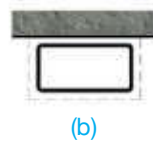
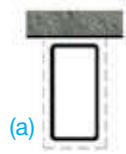
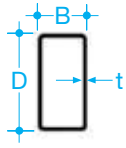

(a)

(b)

Examples of three sides

Four sides

Profile or box protection

Designation		Thickness t (mm)	Area of section (cm ²)	Profile or box protection		
Size D x B (mm)	Mass (kg/m)			(a) Three sides (m ⁻¹)	(b) Three sides (m ⁻¹)	Four sides (m ⁻¹)
160 x 80	14.4	4.0	18.4	220	175	260
	18.0	5.0	22.9	175	140	210
	22.3	6.3	28.5	140	110	170
	27.9	8.0	35.5	115	90	135
	34.2	10.0	43.5	90	75	110
	41.6	12.5	53.0	75	60	90
200 x 100	22.6	5.0	28.7	175	140	210
	28.1	6.3	35.8	140	115	170
	35.1	8.0	44.8	110	90	135
	43.1	10.0	54.9	95	75	110
	52.7	12.5	67.1	75	60	90
	65.2	16.0	83.0	60	50	75
200 x 120	24.1	5.0	30.7	170	145	210
	30.1	6.3	38.3	140	115	170
	37.6	8.0	48.0	110	95	135
	46.3	10.0	58.9	90	75	110
	56.6	12.5	72.1	75	65	90
	63.3	14.2	80.7	65	55	80
200 x 150	70.2	16.0	89.4	60	50	75
	26.5	5.0	33.7	165	150	210
	33.0	6.3	42.1	135	120	170
	41.4	8.0	52.8	105	95	135
	41.0	10.0	64.9	80	80	110
	62.5	12.5	79.6	70	65	90
250 x 100	70.0	14.2	89.2	65	60	80
	77.7	16.0	99.0	55	55	70
	26.5	5.0	33.7	180	135	210
	33.0	6.3	42.1	145	110	170
	41.4	8.0	52.8	115	85	135
	51.0	10.0	64.9	95	70	110
250 x 150	62.5	12.5	79.6	75	60	90
	70.0	14.2	89.2	70	50	80
	77.7	16.0	99.0	65	45	70
	30.4	5.0	38.7	170	145	210
	38.0	6.3	48.4	135	115	165
	47.7	8.0	60.8	110	90	135
250 x 200	58.8	10.0	74.9	90	75	110
	72.3	12.5	92.1	75	60	90
	81.1	14.2	103.0	65	55	80
	90.3	16.0	115.0	60	50	70
	66.7	10.0	84.9	85	80	110
	82.1	12.5	105.0	70	65	90
260 x 140	92.3	14.2	118.0	60	55	80
	30.4	5.0	38.7	170	140	210
	38.0	6.3	48.4	140	115	165
	47.7	8.0	60.8	110	90	135
	58.8	10.0	74.9	90	75	110
	72.3	12.5	92.1	75	60	90
300 x 100	81.1	14.2	103.0	65	55	80
	90.3	16.0	115.0	60	50	70
	30.4	5.0	38.7	180	130	210
	38.0	6.3	48.4	145	105	156
	47.7	8.0	60.8	115	85	135
	58.8	10.0	74.9	95	70	110
300 x 150	72.3	12.5	92.1	80	55	90
	81.1	14.2	103.0	70	50	80
	90.3	16.0	115.0	65	45	70
	54.0	8.0	68.8	110	90	130
	66.7	10.0	84.9	90	70	110
	82.1	12.5	105.0	75	60	90
300 x 150	92.3	14.2	118.0	65	55	80
	103.0	16.0	131.0	60	50	70

Rectangular hollow sections

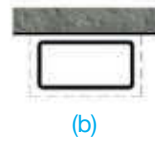
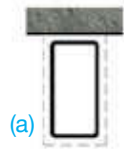
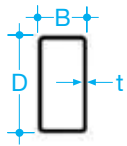

(a)

(b)

Examples of three sides

Four sides

Profile or box protection

Designation		Thickness t (mm)	Area of section (cm ²)	Profile or box protection		
Size D x B (mm)	Mass (kg/m)			(a) Three sides (m ¹)	(b) Three sides (m ¹)	Four sides (m ¹)
300 x 200	38.3	5.0	48.7	165	145	205
	47.9	6.3	61.0	135	115	165
	60.3	8.0	76.8	105	95	130
	74.5	10.0	94.9	85	75	105
	91.9	12.5	117.0	70	60	85
	103.0	14.2	132.0	60	55	75
300 x 250	115.0	16.0	147.0	55	50	70
	52.8	6.3	67.3	130	120	165
	66.5	8.0	84.8	100	95	130
	82.4	10.0	105.0	85	80	105
	102.0	12.5	130.0	65	65	85
	115.0	14.2	146.0	60	55	75
350 x 150	128.0	16.0	163.0	55	50	70
	47.9	6.3	61.0	140	110	165
	60.3	8.0	76.8	110	85	130
	74.5	10.0	94.9	90	70	105
	91.9	12.5	117.0	75	55	85
	103.0	14.2	132.0	65	50	75
350 x 250	115.0	16.0	147.0	60	45	70
	57.8	6.3	73.6	130	115	165
	72.8	8.0	92.8	105	95	130
	90.2	10.0	115.0	85	75	105
	112.0	12.5	142.0	70	60	85
	126.0	14.2	160.0	60	55	75
400 x 120	141.0	16.0	179.0	55	50	70
	49.9	6.3	63.5	145	100	165
	62.8	8.0	80.0	115	80	130
	77.7	10.0	98.9	95	65	105
	95.8	12.5	122.0	75	55	85
	108.0	14.2	137.0	70	50	80
400 x 150	120.0	16.0	153.0	65	45	70
	52.8	6.3	67.3	145	105	165
	66.5	8.0	84.8	115	85	130
	82.4	10.0	105.0	90	70	105
	102.0	12.5	130.0	75	55	85
	115.0	14.2	146.0	65	50	75
400 x 200	128.0	16.0	163.0	60	45	70
	57.8	6.3	73.6	140	110	165
	72.8	8.0	92.8	110	90	130
	90.2	10.0	115.0	90	70	105
	112.0	12.5	142.0	70	60	85
	126.0	14.2	160.0	65	50	75
400 x 300	141.0	16.0	179.0	60	45	70
	85.4	8.0	109.0	105	95	130
	106.0	10.0	135.0	85	75	105
	131.0	12.5	167.0	70	60	85
	148.0	14.2	189.0	60	55	75
	166.0	16.0	211.0	55	50	70
450 x 250	85.4	8.0	109.0	105	90	130
	106.0	10.0	135.0	85	70	105
	131.0	12.5	167.0	70	60	85
	148.0	14.2	189.0	65	50	75
	166.0	16.0	211.0	55	45	70
	85.4	8.0	109.0	110	85	130
500 x 200	106.0	10.0	135.0	90	70	105
	131.0	12.5	167.0	75	55	85
	148.0	14.2	189.0	65	50	75
	166.0	16.0	211.0	60	45	70
	97.9	8.0	125.0	105	90	130
	122.0	10.0	155.0	85	75	105
500 x 300	151.0	12.5	192.0	70	60	85
	170.0	14.2	217.0	60	50	75
	191.0	16.0	249.0	55	45	70
	235.0	20.0	300.0	45	40	55

Circular hollow sections

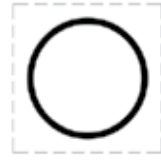
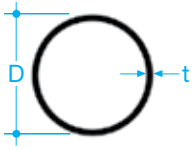

Profile protection

Box protection

Designation		Thickness t (mm)	Area of section (cm ²)	Profile or box protection (m ⁻¹)
Outside diameter D (mm)	Mass (kg/m)			
21.3	1.2	2.6	1.5	440
	1.3	2.9	1.7	400
	1.4	3.2	1.8	370
26.9	1.6	2.9	2.0	425
	1.7	2.9	2.2	385
	1.9	3.2	2.4	355
33.7	2.0	2.6	2.5	415
	2.2	2.9	2.8	375
	2.4	3.2	3.1	345
	2.7	3.6	3.4	310
42.4	2.9	4.0	3.7	285
	2.6	2.6	3.3	410
	2.8	2.9	3.6	370
	3.1	3.2	3.9	340
48.3	3.4	3.6	4.4	305
	3.8	4.0	4.8	275
	4.6	5.0	5.9	230
	3.3	2.9	4.1	365
60.3	3.6	3.2	4.5	355
	4.0	3.6	5.1	300
	4.4	4.0	5.6	275
76.1	5.3	5.0	6.8	225
	4.1	2.9	5.2	360
	4.5	3.2	5.7	330
88.9	5.0	3.6	6.4	295
	5.6	4.0	7.1	270
	6.8	5.0	8.7	220
114.3	5.2	2.9	6.7	358
	5.8	3.2	7.3	325
	6.4	3.6	8.2	290
139.7	7.1	4.0	9.1	265
	8.8	5.0	11.2	215
	10.8	6.3	13.8	175
168.3	6.2	2.9	7.8	355
	6.8	3.2	8.6	325
	7.6	3.6	9.7	290
193.7	8.4	4.0	10.7	260
	10.3	5.0	13.2	210
	12.8	6.3	16.3	170
219.1	8.8	3.2	11.2	320
	9.8	3.6	12.5	285
	10.9	4.0	13.9	260
244.5	13.5	5.0	17.2	210
	16.6	6.3	21.4	170
	10.8	3.2	13.7	320
273	12.1	3.6	15.4	285
	13.4	4.0	17.1	255
	16.6	5.0	21.2	205
323.9	20.7	6.3	26.4	165
	26.0	8.0	33.1	135
	32.0	10.0	40.7	110
355.6	20.1	5.0	25.7	205
	25.2	6.3	32.1	165
	31.6	8.0	40.3	130
406.4	39.0	10.0	49.7	105
	48.0	12.5	61.2	85
	23.3	5.0	29.6	205
457.0	25.1	5.4	31.9	190
	29.1	6.3	37.1	165
	36.6	8.0	46.7	130
508.0	45.3	10.0	57.7	105
	55.9	12.5	71.2	85
	70.1	16.0	89.3	70

Designation		Thickness t (mm)	Area of section (cm ²)	Profile or box protection (m ⁻¹)
Outside diameter D (mm)	Mass (kg/m)			
219.1	26.4	5.0	33.6	205
	33.1	6.3	42.1	165
	41.6	8.0	53.1	130
	51.6	10.0	65.7	105
	63.7	12.5	81.1	85
	71.8	14.2	91.4	75
	80.1	16.0	102.0	65
	98.2	20.0	125.0	55
244.5	29.5	5.0	37.6	205
	37.0	6.3	47.1	165
	46.7	8.0	59.4	130
	57.8	10.0	73.7	105
	71.5	12.5	91.1	85
273	80.6	14.2	103.0	75
	90.2	16.0	115.0	65
	111.0	20.0	141.0	55
	33.0	5.0	42.1	205
	41.4	6.3	52.8	160
	52.3	8.0	66.6	130
	64.9	10.0	82.6	105
323.9	80.3	12.5	102.0	85
	90.6	14.2	115.0	75
	101.0	16.0	129.0	65
	125.0	20.0	159.0	55
	153.0	25.0	195.0	45
355.6	39.3	5.0	50.1	205
	49.3	6.3	62.9	160
	62.3	8.0	79.4	130
	77.4	10.0	98.6	105
	96.0	12.5	122.0	85
	108.0	14.2	138.0	75
	121.0	16.0	155.0	65
	150.0	20.0	191.0	55
406.4	184.0	25.0	235.0	45
	54.3	6.3	69.1	160
	68.6	8.0	87.4	130
	85.2	10.0	109.0	100
	106.0	12.5	135.0	85
	120.0	14.2	152.0	75
	134.0	16.0	171.0	65
457.0	166.0	20.0	211.0	55
	204.0	25.0	260.0	45
	62.2	6.3	79.2	160
	78.6	8.0	100.0	130
	97.8	10.0	125.0	100
	121.0	12.5	155.0	80
508.0	137.0	14.2	175.0	75
	154.0	16.0	196.0	65
	191.0	20.0	243.0	55
	235.0	25.0	300.0	45
	295.0	32.0	376.0	35
	70.0	6.3	89.2	160
	88.6	8.0	113.0	130
508.0	110.0	10.0	140.0	105
	137.0	12.5	175.0	80
	155.0	14.2	198.0	75
	174.0	16.0	222.0	65
	216.0	20.0	275.0	50
	266.0	25.0	339.0	40
	335.0	32.0	427.0	35
	411.0	40.0	524.0	25
508.0	77.9	6.3	99.3	160
	98.6	8.0	126.0	125
	123.0	10.0	156.0	100
	153.0	12.5	195.0	80
	173.0	14.2	220.0	75
	194.0	16.0	247.0	65

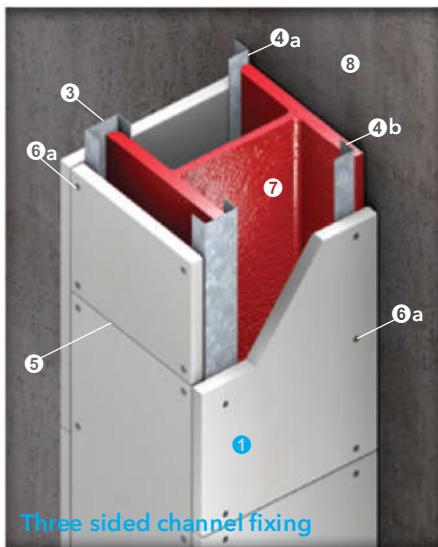
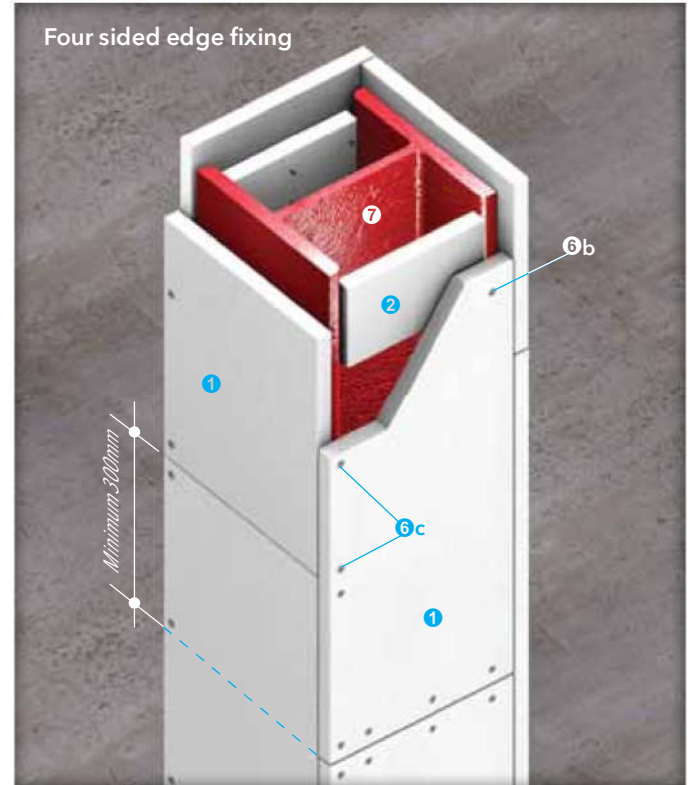
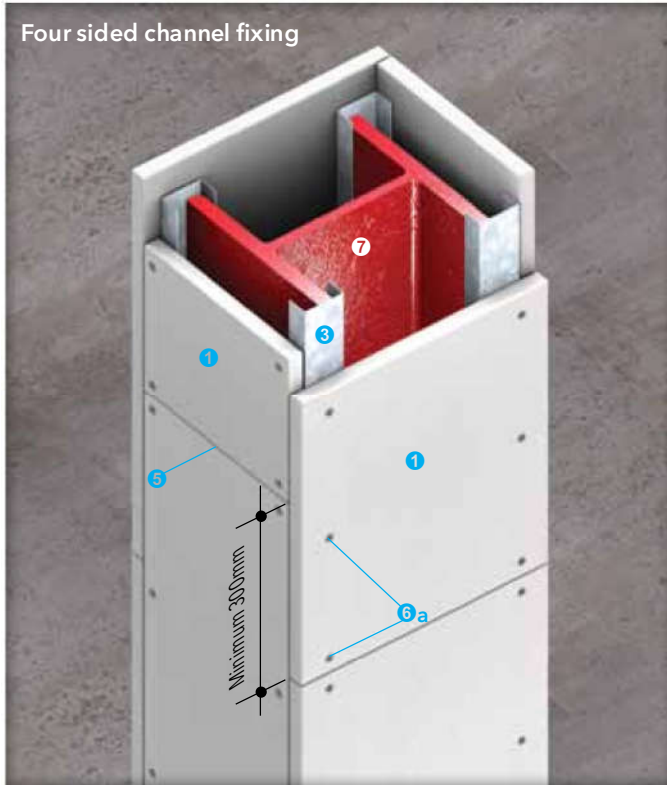

Up to 150/-/- fire resistance in accordance with the requirements of AS 1530: Part 4: 2005

- ① PROMATECT® 100 board, thickness in accordance with the Hp/A Ratio tables on page 53
- ② PROMATECT® 100 soldiers 100mm wide, minimum thickness similar to the board thickness of ①
- ③ Continuous galvanised steel channel 19mm x 38mm x 19mm x 0.8mm thick or similar, leg of each channel is located against inner surface of flange
- ④a Continuous galvanised steel angles minimum 32mm x 19mm x 0.8mm thick or similar fixed to the wall using non combustible proprietary anchors at nominal 500mm centres
- ④b Continuous galvanised steel angles minimum 32mm x 19mm x 0.8mm thick or similar fixed to the flange using Tek screws, shot fired nails or welding. Secure edges of side boards at 200mm centres
- ⑤ Horizontal joints in adjacent board sides to be staggered at minimum 300mm
For wide columns, it is advisable to include a PROMATECT® 100 cover

strip behind the joints within the web of the steel column to provide additional impact resistance

- ⑥a Self-drilling or self-tapping drywall screws fixed to channel/angle at nominal 200mm centres. Screw length should be additional 20mm of the board thickness
- ⑥b Self-drilling or self-tapping drywall screws fixed to soldiers at nominal 100mm centres. Screw length should be additional 20mm of the board thickness
- ⑥c Steel wire staple fixing in accordance with table below. When edge fixing it is advisable to drill pilot holes, particularly with 15mm thick boards. Please consult Promat for further guidance

Board thickness	Steel wire staples at 150mm centres
15mm	44/10/1mm
20mm	44/10/1mm
25mm	50/10/1mm
30mm	60/10/1mm

- ⑦ Structural steel column
- ⑧ Concrete wall substrate

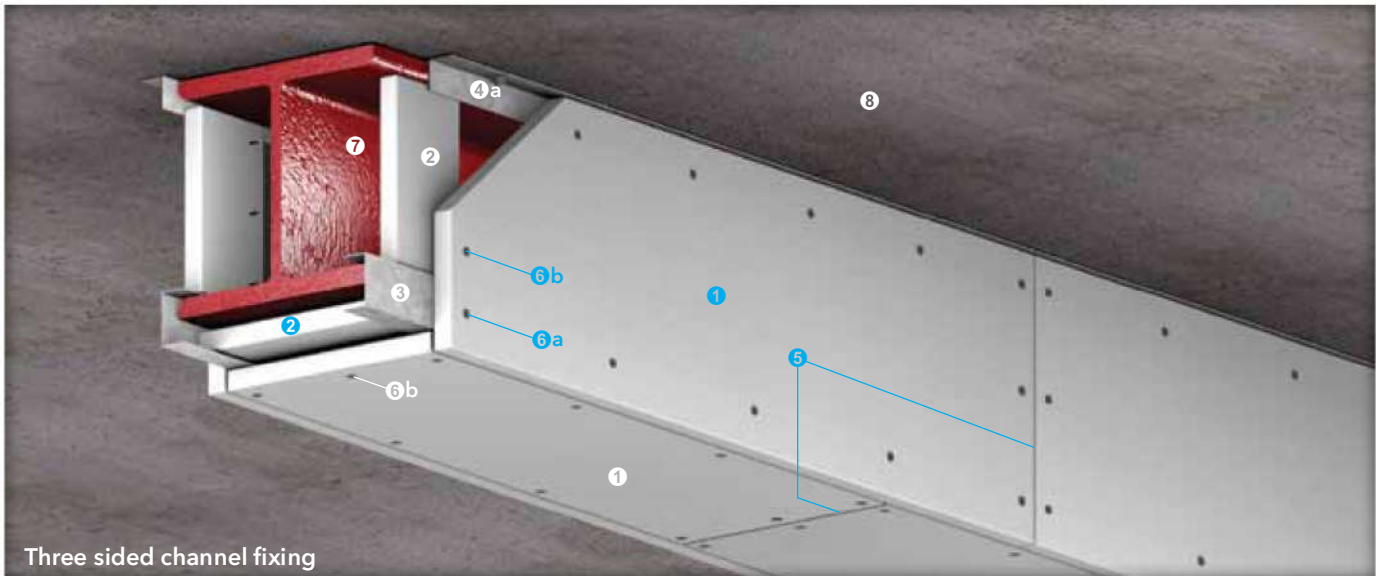

Three sided channel fixing

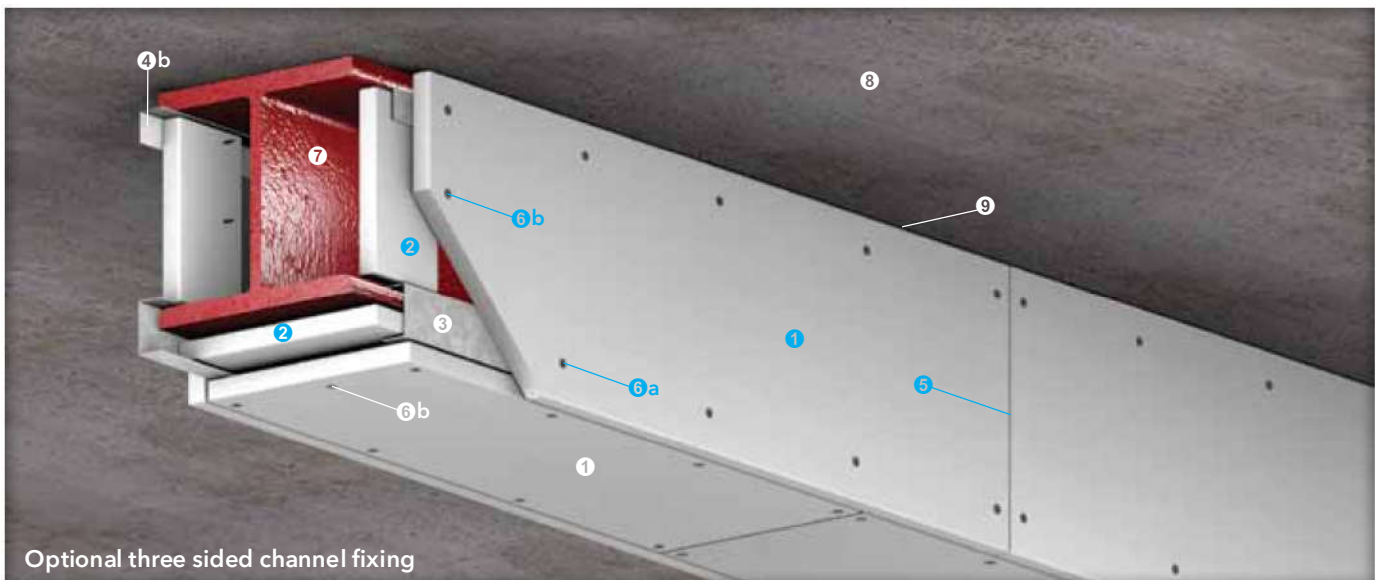

Optional three sided channel fixing

Up to 150/- fire resistance in accordance with the requirements of AS 1530: Part 4: 2005

using non combustible proprietary anchors at nominal 500mm centres

- ① PROMATECT® 100 board, thickness in accordance with the Hp/A Ratio tables on page 53
- ② PROMATECT® 100 soldiers 100mm wide, minimum thickness similar to the board thickness of ①, fixed within the web of the steel beam at maximum 1220mm centres behind the board joints using screws at 100mm centres or using staples at 50mm centres
- ③ Continuous galvanised steel channel 19mm x 38mm x 19mm x 0.8mm thick or similar located at the bottom flange, leg of each channel is facing inner surface of the flange
- ④a Continuous galvanised steel angles minimum 32mm x 19mm x 0.8mm thick or similar fixed to the floor slab
- ④b Continuous galvanised steel angles minimum 32mm x 19mm x 0.8mm thick or similar beneath the upper flange
- ⑤ Vertical and horizontal joints in adjacent board sides to be staggered at minimum 300mm
- ⑥a Self-drilling or self-tapping drywall screws fixed to channel/angle at nominal 200mm centres. Screw length should be additional 20mm of the board thickness
- ⑥b Self-drilling or self-tapping drywall screws fixed to soldiers at nominal 100mm centres. Screw length should be additional 20mm of the board thickness
- ⑦ Structural steel beam
- ⑧ Floor slab
- ⑨ Caulk all edges between the board and the floor slab with PROMASEAL®-A Acrylic Sealant, depth in accordance with the required board thickness

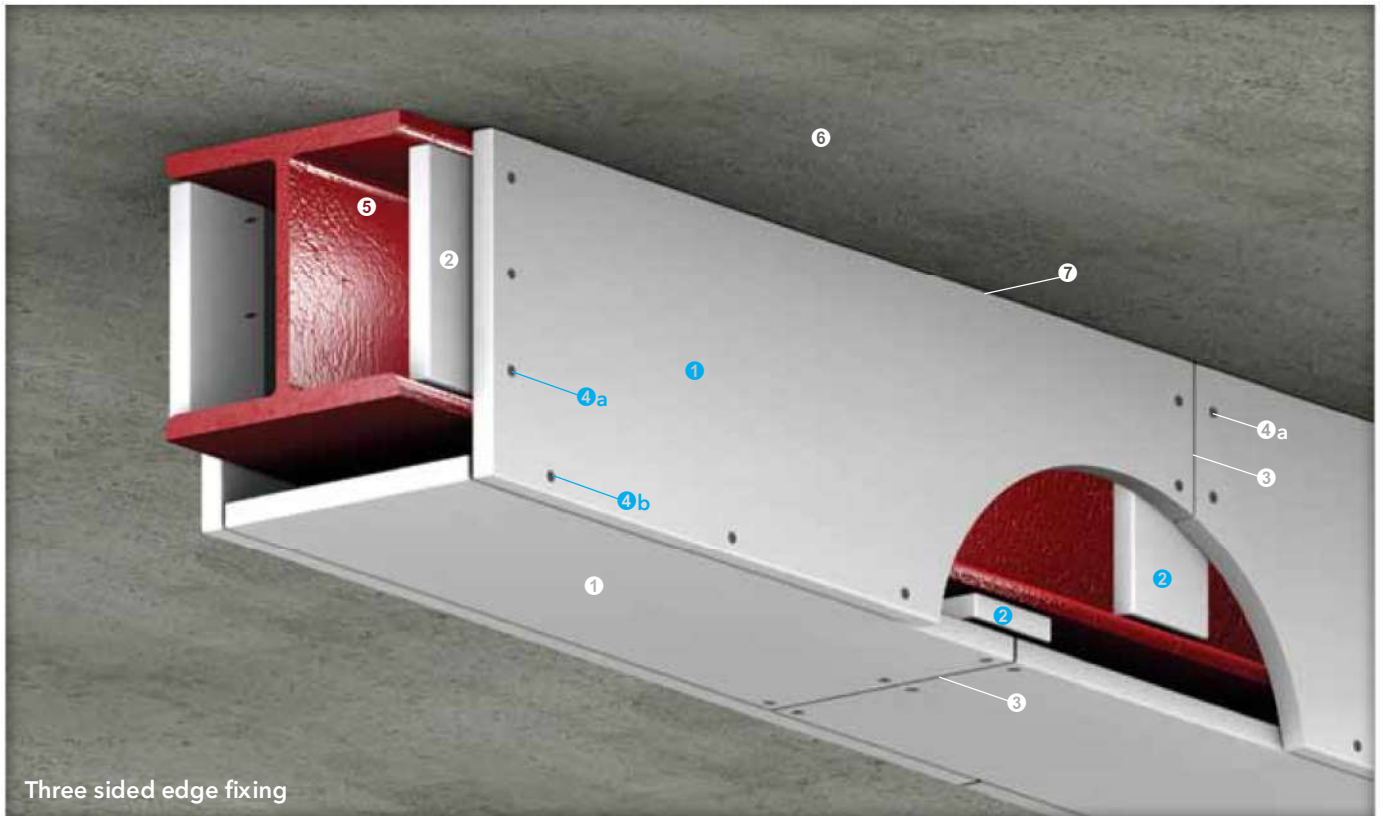

Three sided edge fixing

Up to 150/-/- fire resistance in accordance with the requirements of AS 1530: Part 4: 2005

- ❶ PROMATECT® 100 board, thickness in accordance with the Hp/A Ratio tables on [page 53](#)
- ❷ PROMATECT® 100 soldiers 100mm wide, minimum thickness similar to the board thickness of ❶, fixed within the web of the steel beam at maximum 1220mm centres behind the board joints using screws at 100mm centres or using staples at 50mm centres

For deep beams clad with thicker boards for greater fire resistance, it is advisable to fix the soldiers at nominal 600mm centres in order to reduce the load on the soldiers. For steel beams greater than 600mm deep, a T-section soldier should be used to provide a stronger support
- ❸ Vertical and horizontal joints in adjacent board sides to be staggered at minimum 300mm
- ❹a Self-drilling or self-tapping drywall screws fixed to soldiers at nominal 100mm centres. Screw length should be additional 20mm of the board thickness

- ❹b Steel wire staple fixing in accordance with table below. When edge fixing it is advisable to drill pilot holes, particularly with 15mm thick boards. Please consult Promat for further guidance

PROMATECT® 100 board thickness	Steel wire staples at 100mm centres
15mm	44/10/1mm
20mm	44/10/1mm
25mm	50/10/1mm
30mm	60/10/1mm

- ❺ Structural steel beam
- ❻ Floor slab
- ❼ Caulk all edges between the board and the floor slab with PROMASEAL®-A Acrylic Sealant, depth in accordance with the required board thickness

The following is a standard Architectural Specification for structural steel column and beam protection using PROMATECT® 100. Please note that PROMATECT® 100 can be installed by using either screw or staple type of edge fixing. The end user must determine the suitability of any particular design to meet the performance requirements of any application before undertaking any work. If in doubt, please first obtain the advice from a suitably qualified engineer.

The installation methods described herein are suitable for steel sections up to 686mm deep and 325mm wide. For larger section or when protecting multiple sections within a single encasement, please consult Promat.

Where a column box encasement abuts a beam protected with a profiled fire protection system, e.g. intumescent paint, the column webs should be sealed at their tops using PROMATECT® 100.

Fire Exposure & Area of Application

Exposed faces of steelwork internal to building, for up to 150 minute fire resistance in accordance with the requirements of AS 1530: Part 4: 2005.

Location

(1)

Type of construction

_____ minute⁽²⁾ fire resistance to PROMATECT® 100 one sided, two sided, three sided or four sided encasement of structural steel columns and beams.

Lining boards

_____ mm⁽³⁾ thick PROMATECT® 100 PromaX® mineral boards as manufactured by Promat International (Asia Pacific) Ltd, in size _____ mm x _____ mm⁽⁴⁾, cut to size on-site/pre cut in accordance with the schedule of sizes⁽⁵⁾ and fixed in accordance with the manufacturer's recommended details and fixing instructions.

Screw fixing

COLUMNS

PROMATECT® 100 boards to be fixed by board face to board edge using _____ mm^(6a) self-drilling, self-tapping screws at nominal 200mm centres.

BEAMS

Vertical PROMATECT® 100 boards to be screwed to 100mm wide x _____ mm⁽³⁾ thick PROMATECT® 100 soldiers wedged between flanges at 1200mm centres using _____ mm^(6a) self-drilling, self-tapping screws at nominal 100mm centres.

Where mechanical fixing is required for columns or beams, PROMATECT® 100 boards to be fixed by board face to board edge using _____ mm^(6a) self-drilling, self-tapping screws at nominal 200mm centres to nominal 19mm x 38mm x 19mm x 0.8mm continuous pressed steel channels or similar at bottom steel flange AND to 32mm x 19mm x 0.8mm continuous pressed steel angles secured to soffit of floor/roof slab or top steel flange. The angles should be fixed at nominal 500mm centres.

Staple fixing

COLUMNS

PROMATECT® 100 boards to be fixed by board face to board edge using _____ mm^(6b) staples at nominal 100mm centres.

BEAMS

Vertical PROMATECT® 100 boards to be screwed to 100mm wide x _____ mm⁽³⁾ thick PROMATECT® 100 soldiers wedged between flanges at 1200mm centres using _____ mm^(6b) staples at nominal 50mm centres.

Continued on opposite page

Butt jointing for screw fixing

For beam casings only, PROMATECT® 100 board joints in the soffit to be backed with 100mm wide x minimum _____ mm(3) thick PROMATECT® 100 internal cover strips secured with _____ mm(7) self-drilling, self-tapping screws at nominal 100mm centres.

Butt jointing for staple fixing

For beam casings only, PROMATECT® 100 board joints in the soffit to be backed with 100mm wide x minimum _____ mm(3) thick PROMATECT® 100 internal cover strips secured with _____ mm(7) staples to one side of board joint only.

Follow-on trades

Surface of boards to be prepared for painting/plastering/tiling(8) in accordance with manufacturer's recommendations.

NOTE:

- ⁽¹⁾ insert location, e.g. "beams and columns to offices interior", or provide steelwork drawing reference.
- ⁽²⁾ insert required fire resistance level not exceeding 150 minutes.
- ⁽³⁾ insert required thickness by reference to section factor (Hp/A) and fire resistance level.
- ⁽⁴⁾ select board size on basis of economy in cutting. Standard board size is 2500mm x 1200mm.
- ^{(5), (8)} delete as appropriate.
- ^(6a) insert screw length which gives minimum 25mm penetration having regard to encasement thickness.
- ^(6b) insert staple length which gives minimum 25mm penetration having regard to encasement thickness.
- ⁽⁷⁾ insert screw length which is minimum 5mm longer than twice the encasement thickness.

Hp/A ratio table 1 Up to 150/-/ fire resistance in accordance with the requirements of AS 1530: Part 4: 2005 (report no. BRANZ FAR 3015) for structural steel column protection at critical temperature of 550°C

Fire resistance	PROMATECT® 100 board thickness (mm)					
	15	20	25	30 (15 x 2 layers)	35 (20 + 15, 1 layer each)	40 (20 x 2 layers)
30 minutes	260	260	260	260	260	260
60 minutes	260	260	260	260	260	260
90 minutes	114	185	260	260	260	260
120 minutes	68	102	145	201	260	260
150 minutes	–	70	96	126	163	190

Hp/A ratio table 2 Up to 150/-/ fire resistance in accordance with the requirements of AS 1530: Part 4: 2005 (report no. BRANZ FAR 3015) for structural steel beam protection at critical temperature of 550°C

Fire resistance	PROMATECT® 100 board thickness (mm)					
	15	20	25	30 (15 x 2 layers)	35 (20 + 15, 1 layer each)	40 (20 x 2 layers)
30 minutes	260	260	260	260	260	260
60 minutes	260	260	260	260	260	260
90 minutes	102	162	249	260	260	260
120 minutes	–	92	129	176	238	260
150 minutes	–	–	87	114	146	168

Hp/A ratio table 3 Up to 150/-/ fire resistance in accordance with the requirements of AS 1530: Part 4: 2005 (report no. BRANZ FAR 3015) for structural steel beam protection at critical temperature of 620°C

Fire resistance	PROMATECT® 100 board thickness (mm)					
	15	20	25	30 (15 x 2 layers)	35 (20 + 15, 1 layer each)	40 (20 x 2 layers)
30 minutes	260	260	260	260	260	260
60 minutes	260	260	260	260	260	260
90 minutes	115	232	249	260	260	260
120 minutes	–	94	149	243	260	260
150 minutes	–	–	85	120	171	213

For single layer application of ≥30mm thick PROMATECT® 100 board, please consult Promat.

Partitions



Steel stud partition type	Fire resistance performance	STC	R _w	Board layer and thickness	Typical system weight	Total partition thickness	Test/Approval no.	Page no.
 <p>PROMATECT® 100 single steel stud partition (double sided)</p>	-/90/60	Up to 50dB	Up to 50dB	1 x 15mm (each side)	* From 27kg/m ²	From 94mm	BRE P106900-1005 AS 1530: Part 4: 2014	80
	-/120/120	Up to 48dB	Up to 50dB	1 x 20mm (each side)	* From 35kg/m ²	From 104mm	WFRA45883 AS 1530: Part 4: 2014	81
	120/120/120	Up to 48dB	Up to 50dB					
 <p>PROMATECT® 100 single steel stud partition (double sided)</p>	-/240/240	Up to 55dB	Up to 59dB	2 x 20mm (each side)	* From 70kg/m ²	From 164mm	BRE P106900-1005 to the requirements of AS 1530: Part 4: 2014	87
 <p>PROMATECT® 100 double steel stud partition (double sided)</p>	-/120/120	Up to 57dB	Up to 60dB	1 x 20mm (each side)	* From 36kg/m ²	From 178mm	WFRA 45883 to the requirements of AS 1530: Part 4: 2014	95
 <p>PROMATECT® 100 timber stud partition</p>	-/90/90	Up to 35dB	Up to 39dB	1 x 20mm (each side)	* From 37kg/m ²	From 130mm	BRANZ FR6112 AS 1530: Part 4: 2014	99
	90/90/90	Up to 35dB	Up to 39dB					
 <p>PROMATECT® 100 solid/frameless internal partition</p>	-/120/120	Up to 36dB	Up to 36dB	2 x 20mm	* From 34kg/m ²	40mm	BRANZ FAR3309 AS 1530: Part 4: 2005	103

* For partitions up to 3000mm. Stud sizes may increase for partitions above 3000mm of height. Please consult Promat.



Introduction

Partitions are used to separate buildings, enclose compartments and contain fire by providing a barrier to the passage of fire from one side or the other, or both. In doing so, they are able to satisfy each of the relevant fire resistant criteria (integrity, insulation and, if the wall is loadbearing, load bearing capacity) from either side for the prescribed period.

The application of partition and external wall systems using Promat boards covers both non loadbearing and loadbearing in commercial, industrial, institutional, residential and high rise constructions, or in the restoration of existing buildings. Promat's internal partition systems require less material to achieve similar fire resistant level when compared to industry average wallboard partition systems. The single layer board application leads to simplified construction methods over other equivalents and in turn to increased productivity and reduced overall installation cost.

These partition and external wall systems have been developed by Promat International (Asia Pacific) Ltd to satisfy standard requirements for intended applications. Such considerations include:

Time & cost effectiveness

Single layer application reduces installation cost and time compared to traditional wallboard constructions.

Slim walls

Partitions can be as thin as 35mm.

Lightweight

Lighter loads on structures compared to industry average wallboard partition systems for equivalent fire resistance.

Thermal resistance

Excellent thermal resistance performance. **Impact resistant** PROMATECT®-H partition systems have been tested for resistance to impact, stiffness and robustness in accordance with the criteria of BS 5234: Part 2.

Acoustic performance

Tested and assessed to a range of standards, including ISO 140-3: 1995, ISO 717-1: 1996, AS 1191: 2002, AS/NZS 1276: Part 1, BS 5821: 1984 and BS 2750: Part 3: 1980, to meet the needs of industry. Please refer to [pages 64 to 66](#) for details.

Fire resistance performance

Promat partitions and external wall systems have been extensively tested and assessed in accordance with BS 476: Parts 21 and 22 and AS 1530: Part 4 to satisfy the integrity, insulation and where applicable loadbearing capacity (structural adequacy) criteria.

General design considerations for partitions

Following are some of the factors to take into account when determining correct specifications that ensure a partition provides required design performance under both fire and ambient conditions.

Studwork design

The design of studwork should be adequate for the height of the partition. The studwork details given in the following specifications are suitable up to the maximum heights stated. For greater heights the dimension of the framing members could change depending upon factors such as movement and deflection, and local approvals. Larger or more frequent frame sections will often improve fire and structural performance.

The studwork shall be appropriately designed for the applied loads, e.g. wind load, and where applicable structural load in the case of load bearing systems. The framing for the partition systems must be securely fixed back to a substrate that has an equal or greater fire performance than the designed partition. All fixings must be non combustible and must be those listed in the approval documents. The design shall be in accordance with the relevant British, Australian and/or International Standards.

Non loadbearing partitions

Non loadbearing partitions and external wall systems using Promat boards can be generally categorised as framing systems consisting of steel or timber studs and solid partitions. For steel stud systems, selection of suitable stud size shall be in accordance with the maximum partition height given in the stud selection tables. The partition systems in the following pages, where stated, are designed for lateral loads of up to 0.25kPa using the composite action of the frame and boarding.

Loadbearing partitions

Loadbearing capacity of featured partition systems in this handbook are calculated in accordance with AS 4600: 2018 for load cases defined by AS 1170: 2002. The maximum load bearing capacity is given in kN for a given partition height taking into account the reduction in steel strength at elevated temperature.

Studs are located at 600mm maximum centres with noggings. Loads considered in this manual are for axial compression only. Wind and other loads have not been taken into consideration. For further information on these loads, please consult Promat.

Deflection

Where differential movement is expected between the floor or beam above the construction and/or the floor below, it is generally advisable to incorporate a deflection head track to ensure undue stress is not placed upon the partition. This also allows for the sagging and deflection of a floor or structural beam will be subjected to under fire conditions. Even concrete floors will suffer considerable deflection under fire if exposed for any extended duration.

Some form of movement joint is also required to allow for the expansion of the studs under fire conditions. A partition will also bow at its centre. As the wall bows, it naturally becomes shorter. For this reason alone, use should be made of a top track with long side legs. This will allow the stud to bow and as a result drop down, without the studs dropping out of the head track.

Movement joint

Movement stress from dimensional changes due to varying temperature or moisture conditions can cause cracking and other symptoms of distress in partitions. Other external forces such as impact or vibration can directly affect the structural movement of partitions. This movement can be controlled through a variety of design techniques such as introducing perimeter relief and slip connections to reduce the transfer of stress from the structure to other building sub elements and/or through the use of expansion joints, control joints and construction joints.

In a partition, expansion joints are needed when the partition abuts a rigid mass. A vertical movement joint should be located at maximum 10000mm centres in long runs of partition. However, introducing a control joint into a fire resistant partition creates an opening for flame and temperature transmission. Such openings must also be treated with approved fire stopping systems.

Please refer to [page 71](#) for further details on movement joints.

Caulking & service penetrations

To maintain fire and where applicable acoustic performance of the partition system, gaps at the perimeter must be appropriately filled with suitable caulking material. PROMASEAL®-A Acrylic Sealant or other tested fire and acoustic resistant material of equivalent or better performance must be used.

Care needs to be taken in detailing a suitable fire stopping system around any penetration of the partition by services to ensure that the fire-stopping material remains in situ, and fire and smoke do not penetrate the partition.

Allowance should be made for thermal movement of the services in both ambient and fire conditions to ensure loads are not applied to the partition. Some examples of service penetrations include electrical cables, conduits or wires, switches and power outlets, plastic and metal pipes, air conditioning and ventilation ductwork. Further guidance on the penetration seals of these elements can be obtained on the PENETRATION SEALS section this handbook.

Fire doors & glazing

Tested or assessed door and/or glazed assemblies should always be used. All and any doors or glazed elements with a fire resistant wall should be shown, by fully compliant testing to the appropriate standard, to be capable of providing at least an equal fire performance to the wall itself. This means fire doors should be tested in lightweight partition systems, not just in masonry. In most cases additional framework will be required to prevent loads being applied to the partition. Careful detailing is needed around the perimeter of any door or glazed assembly. Further guidance on the detailing at fire doors and glazing is available on [page 72](#).

Partition junction

Care must be taken to ensure that partition corner junctions and intersections are stable for both fire and ambient conditions. Framing at these locations must be mechanically fastened together. Further information on the detailing these junctions can be found on [page 67](#).

Board fixing

Promat boards can be installed horizontally or vertically.

For steel stud partition system, joints in the boards must be staggered between either side of the framing with all the joints located at a framing member. The boards may be fixed to the studs using No.8 bugle head self-drilling and self-tapping screws of a length appropriate for the board thickness. Needle point screws are normally used to fix boards to light gauge steel frames up to 0.8mm. Drill point screws are generally appropriate for heavy gauge steel frames from 0.8mm to 2.0mm.

When a timber frame is used, Promat boards are fixed to the framework using screws or nails of a length appropriate for the board thickness and the required fire resistance performance at nominal 300mm centres and minimum 12mm from the board edge. Minimum edge distance to fasteners and the maximum spacing between screws or nails must be maintained.

Internal and external corners may be set using a perforated metal corner bead fixed to the board linings at not more than 500mm centres.

Steel frame components

Components selection

Construction of Promat fire resistant steel stud partitions can be achieved using stud and track components. Other steel components of equivalent performance can of course be used but it is the responsibility of the manufacturer of the component to substantiate equivalent performance with the recommended component.

Deflection head & bottom tracks

The main function of the ceiling and floor tracks is to hold the studs in position until the board is fitted. They provide a friction fit for the studs and also act as a slip joint to allow for any movement in the structure.

The track sections come in two basic profiles. A standard track has a nominal 32mm flange whilst the deflection head track has a nominal 50mm flange. However, head tracks with wider flange are available but they have to be specially designed for instances where clearance for expansion at the head track exceeds 20mm.

No clearance for expansion is applicable at the head track for a loadbearing partition. Track sections should be fixed at maximum 600mm intervals to the supporting structure. Fixings should be located not more than 100mm from either end of the track section.

Vertical studs

The recommended studs come in 0.50mm, 0.55mm, 0.75mm and 1.15mm. The 0.50mm to 0.75mm studs have standard 25mm bell-mouthed service holes for electrical cabling. For the 1.15mm stud, round holes are punched at designated centres along the stud.

Spliced extensions are possible in situations where the overall height of the partition is more than the stud length. The 0.50mm to 0.75mm studs may be boxed and the 1.15mm studs may be spliced back to back.

For greater rigidity at fire resistant glazing and door openings, and also at locations where extra load carrying capacity is required, studs of 0.50mm to 0.75mm may be boxed and studs of 1.15mm may be fixed back to back. See guide below on spliced studs and stiffening framing.

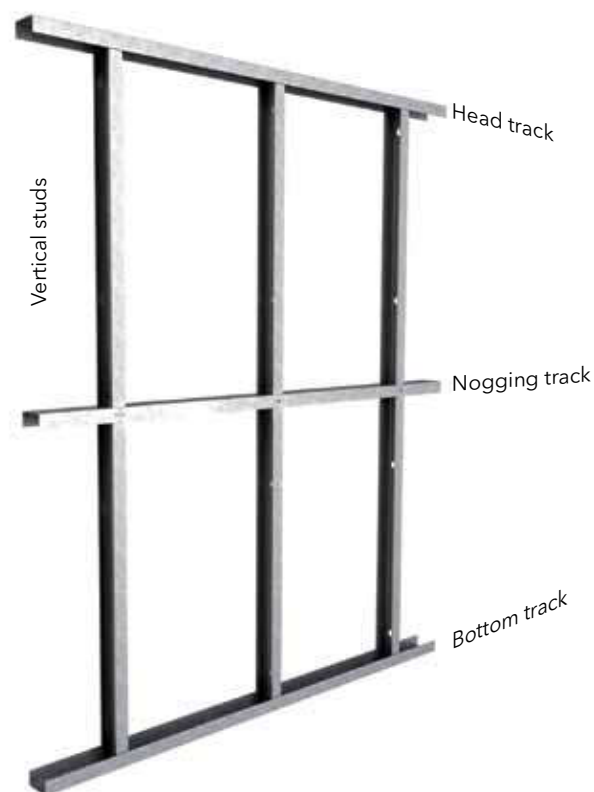

Fixing of spliced vertical studs for partition heights up to 7000mm

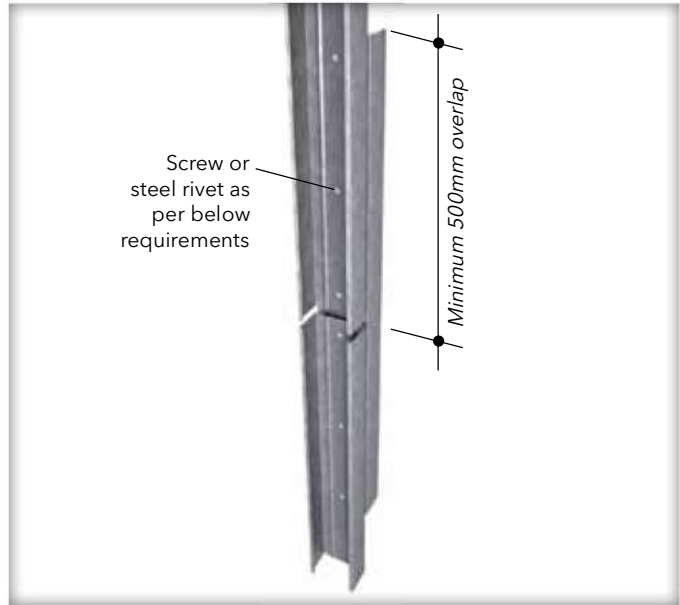
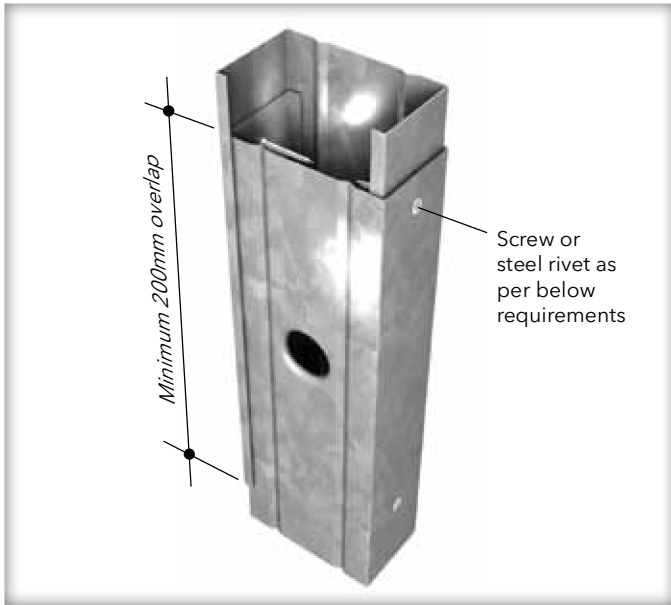

1. 0.50/0.55/0.75mm studs

Splice location in wall	Minimum required fasteners on both sides of studs over the splice
Up to 10%	2 pieces
10% to 25%	3 pieces

2. 1.15mm studs

Splice location in wall	Minimum required fasteners on both sides of studs over the splice
Up to 10%	3 pieces
10% to 25%	5 pieces

NOTE: The splice location percentage refers to the height of the partition. For example, taking a partition 10000mm high, a 10% splice location would be located within 1,000mm of the top or bottom of the wall. A 25% splice location would be within 2000-5000mm of the top or bottom of a 10000mm high wall.

- Splices should be alternate subsequently at top and bottom of wall
- Do not splice studs between 25% and 75% of wall height
- Splicing of studs is recommended for non loadbearing partitions only
- Where splicing is not possible due to the height, use fully boxed sections

Nogging track

Noggings are necessary to provide bracing to the partition studs and preventing the studs from twisting when fitting the lining boards. The noggings are to be screwed, riveted or crimped to both flanges of the studs. Continuous nogging tracks 0.55mm and 0.75mm are available from Rondo. This nogging track can be fitted to the stud framing in one length. Alternatively, individual noggings may be cut from the track. Noggings of 0.75mm can be used with 1.15mm studs.

TOP TRACK FIXING

Track to be structurally designed in accordance with BS 5950 or AS 4600, for the given opening dimensions.

BOTTOM TRACK FIXING

Track to be fastened to substrate floor and ceiling with M6 anchor bolts 40mm long at maximum 600mm centres. Studs can be installed vertically at 600-610mm centres depending on the board size used.

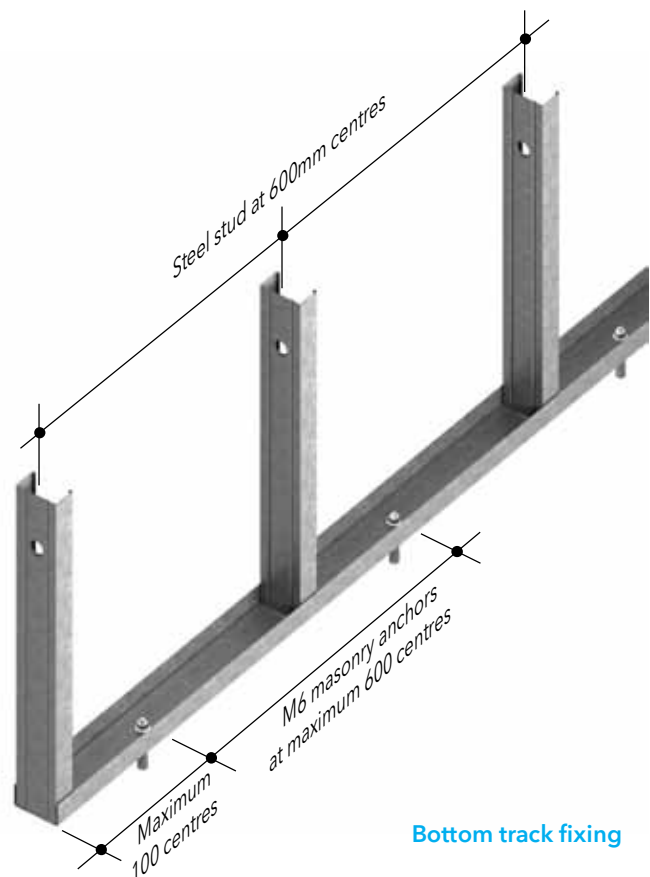

Bottom track fixing

Horizontal track using steel studs

- Studs to be cut to a short length and screwed in between each of the vertical studs.
- Cut the base of the track leaving two short studs either side. Insert the noggings between the vertical steel studs and fix through the studs into the vertical studs on either side, using only steel rivets or screws.
- All horizontal joints of the boards are to be fixed to the noggings.

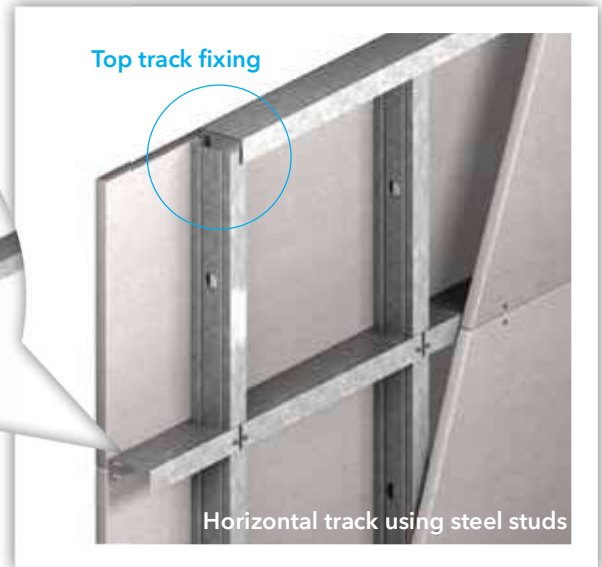
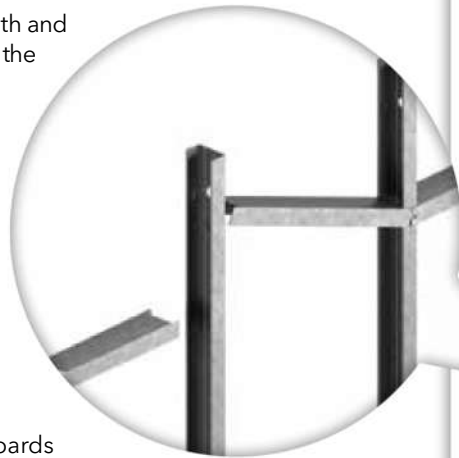

Horizontal track using steel channels

- Steel channel cut to length and screw fixed to the both sides of the vertical studs.
- All horizontal joints of the boards are fixed to the noggings.

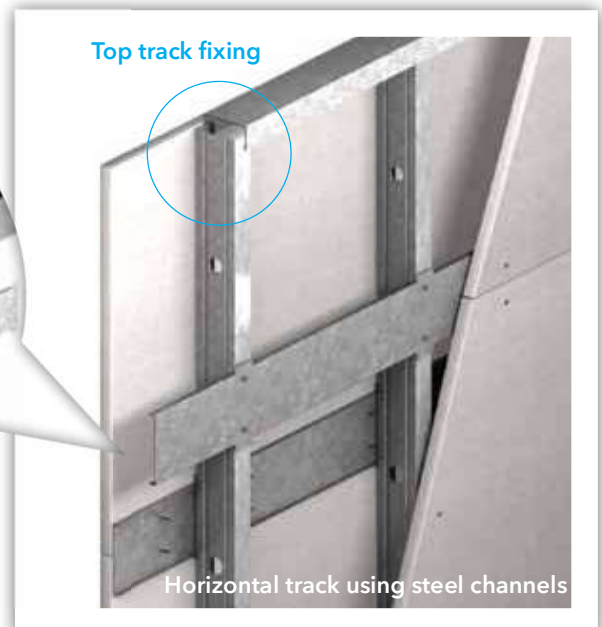
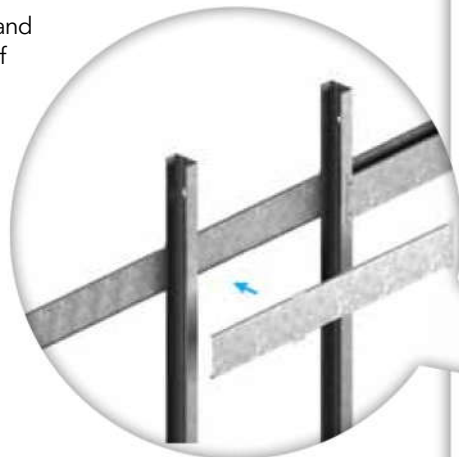

Horizontal joints with board strips

- Cover fillets minimum 75mm wide cut from main lining boards. Fix board to board using stitching screws of a length appropriate to the board thickness, at maximum nominal 200mm centres.
- All horizontal joints of the boards to be covered and fixed by board strips.

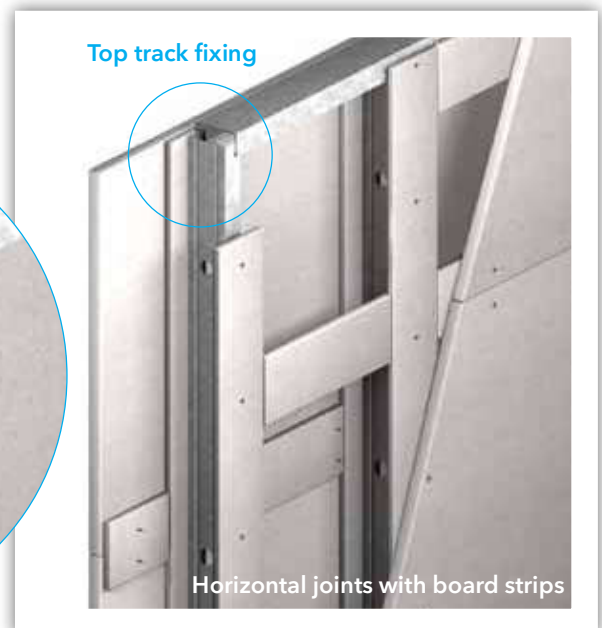
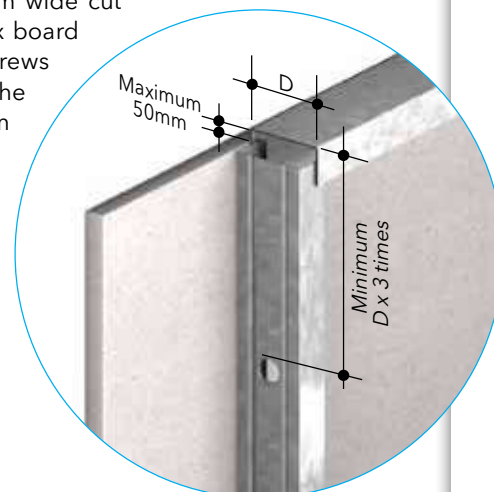

Top track fixing



Timber Frame Components

Timber frame

Timber has very good performance in fire. It does burn but at a relatively slow and to a predictable depth known as the charring rate. This is one major advantage of using timber over steel because the fire resistance of timber elements of construction may be calculated based on a predictable charring rate.

Timber also has a very low thermal conductivity value and hence does not heat uniformly. Therefore, timber material a few millimetres inside the burning zone is just warm. The formation of a self insulating char provides some resistance to further heat penetration.

Unlike materials with a high thermal conductivity such as steel, there are less problems associated with expansion or loss of strength due to increases in temperature over the whole section in timber. This means that in some instances timber retains its structural integrity better than steel.

There are many different types of timbers and they all char at varying rates. Higher density timbers char generally (but not always) more slowly than those of lower density. Denser hardwoods used for structural purposes, such as jarrah, teak, keruing and greenheart, char at a rate of approximately 15mm in 30 minutes. Lower density (<math><650\text{kg/m}^3</math>) softwood timbers such as Western red cedar have an estimated charring rate of 25mm in 30 minutes.

Tables are available which can provide a definitive charring rate for a specific timber species, and can be based on the use of heartwood or sapwood of the given species.

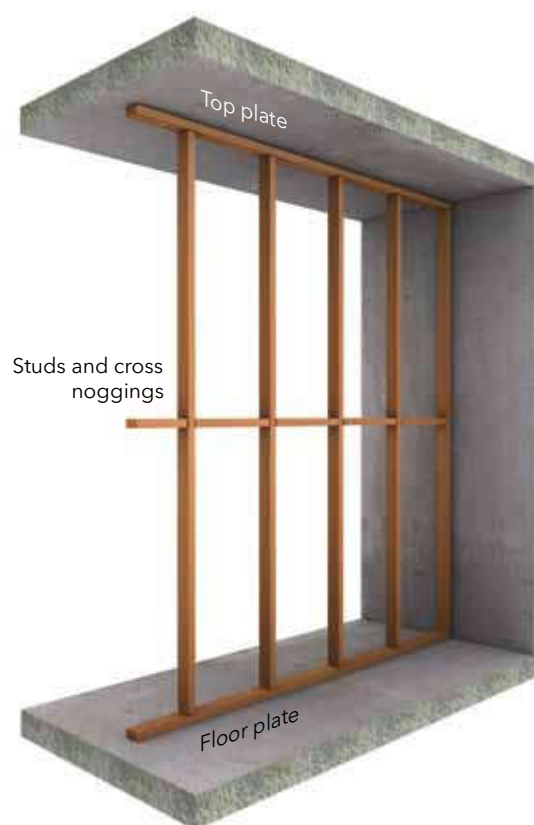

Studs & cross noggings

The frame used in timber stud partitions generally consists of 90mm deep x 45mm wide softwood timber. The fire performance of the partition system accounts for the loss of the timber section due to charring effect without compromising the fire performance of the partition.

Where the boards are to be installed with their long edges vertical, the studs are located at maximum 600mm or 610mm centres (depending on the board width) with cross noggings at 1200mm or 1220mm centres. Where the boards are to be installed with their long edges horizontal, the studs are located at 600mm or 610mm centres with cross noggings at 1200mm or 1220mm centres.

The cross noggings may be fixed to the studs using nails or woodscrews of at least 100mm long. See fixing methods at left. Either method can be adopted to fix the cross noggings.

Top & floor plates

The top and floor plates are to be of the same material and dimensions as the studs. They are to be secured to the surrounding structure with minimum 100mm long M6 masonry anchors with minimum 600mm centres with the drilled depth into the concrete structure of at least 40mm. Polyamide nylon anchor sleeves may be allowed for use with timber framing.

The vertical studs are fixed to the top and floor plates using either nails or woodscrews of at least 100mm long in the manner shown in the left picture.

Loadbearing partition

Where a partition is loadbearing, the required size of the stud shall be calculated by a suitably qualified structural engineer. Care should be taken to ensure that the loadbearing partition has been designed to resist all applied loads and in accordance with BS 5268: Part 4, AS 1720: Part 1 or AS 1684. Generally, the fire performance and the load carrying capacity will improve by increasing the cross-sectional dimensions of the timber elements and/or decreasing the stud spacing.



Cross noggling method 1

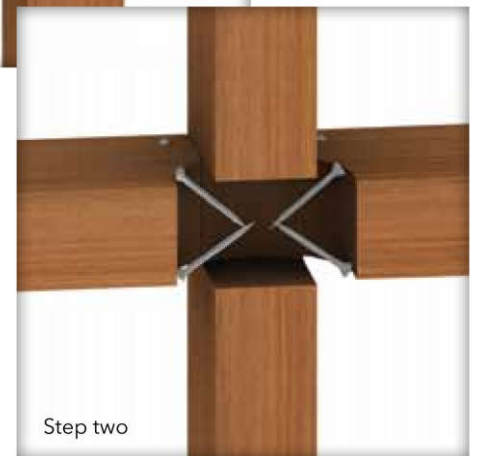

Cross noggling method 2

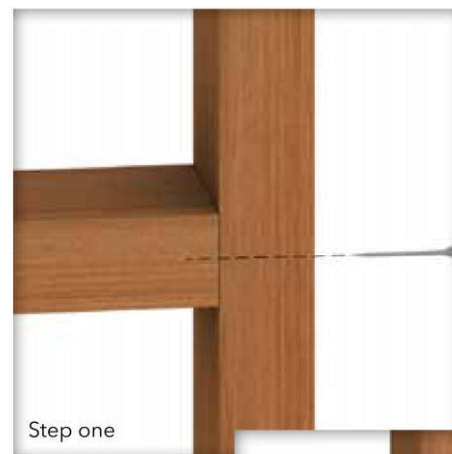



Acoustics in building

Sound is a form of energy generated by a source, transmitted through a medium and collected by a receiver. It can be pleasant to be heard, such as music and speeches etc, while some, such as scratching a glass surface with a sharp object, are irritating. This offensive sound is commonly termed noise. The acoustic design of buildings can be divided into two basic requirements, noise control and room acoustics.

Noise control relates to the quantity of sound with an objective to ensure the sound level does not adversely affect the comfort of building occupants. This involves control of sound produced in a room, such as telephones ringing, as well as limiting the noise entering from other rooms or outside the building. A common solution targeting this problem is the introduction of sound absorption systems.

Room acoustics relate to the quality of sound with an objective to enhance the quality of desired sound within a room. This involves factors such as speech intelligibility and perception of musical clarity. The most widely applied solution employed by building designers is the use of a sound insulating system.

A point worth noting is that although both noise control and room acoustics have independent objectives, they are however inter-related in practice. As this section of technical handbook covers partition and ceiling systems, the following concentrates only on issues related to sound insulation which involves transmission loss (TL) of airborne sound.

Sound transmission & classification

The sound transmission loss of a building element, such as a partition, is a measure of how much sound is reduced as it passes through the barrier, expressed in dB or decibels, the unit used to quantify sound. The generally accepted term for the single number ratings for sound transmission loss is the Sound Transmission Class or STC (ASTM E413-87). This is determined by comparing the TL value to the reference curve in ASTM E413-87. Generally the higher the STC value, the better the performance of the system. The following table provides a rough idea of what various STC levels mean in terms of privacy afforded.

STC	Privacy afforded
25	Normal speech easily understood
30	Normal speech audible, but unintelligible
35	Loud speech understood
40	Loud speech audible, but unintelligible
45	Loud speech barely audible
50	Shouting barely audible
55	Shouting not audible

Source: U.S. Dept of Commerce/National Bureau of Standards Handbook, "Quieting: A Practical Guide to Noise Control".

Another widely accepted equivalent term is the Weighted Sound Reduction Index or R_w (ISO 717: Part 1: 1996 or BS 5821: Part 1: 1984). It is determined in a similar manner but instead of TL values, an equivalent Sound Reduction Index (R or R_w), is used.

Note should be taken that results obtained in STC and R_w may have a ± 3 dB deviation from one another.

Most building structures are not built like laboratories and it is very common that the sound insulation rating measured in ideal test conditions will not be achieved in a building. In order to meet the desired level of performance, building designers should therefore carefully consider the compatibility of the selected system with the supporting structure. Note that field performance is typically lower than laboratory performance by approximately 10%.

General design considerations

With modern design concepts and technology in building construction, acoustic performance within buildings has become an important element for consideration by building designers. There are many factors involved in establishing an ideal noise level for any particular building space, some of which are as follows:

Continued on opposite page

- To avoid fatigue induced by noise;
- To prevent distraction or disturbance;
- To maintain a good communication and listening environment.

Heavy walls such as concrete have good transmission loss. However, there are some drawbacks which limit their performance. Mass law dictates that a wall will increase its transmission loss by only 5dB for every doubling of mass. Therefore, a single 100mm thick concrete wall of 2300kg/m³ density might have an STC 45 rating whereas a 200mm thick concrete wall would only achieve STC 50 for a doubling in mass.

For most owners and builders, a wall of this size and weight is not desirable. Cost may more than double and the decibel-per-dollar achieved is clearly not acceptable. This limitation can be easily overcome by using a lightweight system, i.e. the partition system, where it is more practical to utilise principals such as air cavity, resilient mountings, sound absorbing core materials or a combination of these principals without the large increase in mass required for solid walls.

Following are some common practices that are effective for noise control and room acoustics.

1. Double studding & air cavity

With typical dry wall partitions, sound striking at the wall surface is transmitted through the first surface material into the wall cavity. It then strikes the opposite wall surface, causing it to vibrate and transmit the sound into the air of the adjoining room. This is termed airborne sound. When the sound strikes the wall at the stud, sound is transmitted direct through the stud and is termed structure borne sound.

The principal of double studding basically means separation of two panels of a drywall partition into a double-leaf wall, integrated with appropriate air spacing (cavity) between the leaves. The introduction of an air-space provides some form of separation or discontinuity between the two wall faces in a double-leaves wall.

As an example, a double stud partition creating an air cavity eliminates direct mechanical connection between the surfaces. The sound transmission is reduced by breaking the sound path. In addition, the air cavity provides vibration isolation between the two sides. Sound in one room striking the one side of the wall causes it to vibrate but because of the mechanical separation and the cushioning effect of the cavity, the vibration of the other side is greatly reduced.

2. Sound absorbing core material

Sound absorption is the effectiveness of a material at preventing the reflection of sound. Generally, the more sound absorption, the fewer echoes will exist. The sound absorbing core used in the Promat partition designs can be mineral or rock wool, glass wool or polyester, depending upon fire resistance requirements.

This core will further improve the sound isolation performance of the wall by absorbing sound energy in the cavity before the sound can set the opposite wall surface in motion. They will also provide some damping of the vibrating wall surface.

3. Treatment to flanking paths

When working with acoustic systems, it is critical that strict attention be paid to construction and detailing. The acoustic integrity of a system can be influenced by the combination of elements that make up the system. Single leaf and uninsulated systems are particularly dependent on high quality of installation. For example, if there is a gap of 5mm wide around the perimeter of an STC 45 rated wall of 3m x 3m, the actual performance would degrade to about STC 30. Therefore, to make acoustically rated partitions effective, they must be airtight. Any path for air also means there is a path for sound. In order to achieve the designed STC rating closely, the following factors must also be taken into account:

- Sound paths, e.g. windows, doors, floors and ceilings;
- Penetrations through walls, even above ceilings or below floorings, must be sealed;
- Stagger the joints between multiple layers of wall boards or ceiling linings;
- Do not install electrical points back to back on either side of a wall;
- Openings for return air in ceiling plenum systems must be strictly controlled.

4. Wall & floor intersections

A good acoustic partition is only as good as its joint or intersection at wall and floor, like a chain and its weakest link. If this joint or intersection is not treated properly, the acoustic value may be lost. Many joint defects from flanking paths allow sound to travel via air gaps through the structure.

Acoustic sealants are the simplest means to provide a permanent air tight seal. They are made from materials that are permanently elastic which will allow floor or wall materials to move, as they are prone to do because of expansion and contraction or outside forces such as structural movement. A permanent airtight seal is the most effective way to maintain the acoustic integrity of the wall. Regardless of which system is employed, all openings, cracks and material joints should be made air tight with a permanently elastic acoustical sealant.

System selection guide

As sound insulation requirements may vary from country to country, the table below suggests acoustic values for some typical partition installations, unless otherwise specified by the architects. Please consult Promat for more information.



Some sources of sound leakage

- ① Air leaks through gaps or cracks
- ② Doors
- ③ Lightweight panels above doors
- ④ Electrical outlets and service pipes
- ⑤ Partition performance
- ⑥ Sound transmission via suspended ceilings or partitions
- ⑦ Common floor heating duct
- ⑧ Common ventilation system without sound absorbents treatment
- ⑨ Lightweight mullion or partition closer
- ⑩ Appliance

STC rating			Applications for separating
Minimum	Average	Luxury	
45dB	50dB	55dB	Bedroom to bedroom
50dB	55dB	60dB	Bedroom to living room
50dB	55dB	60dB	Bedroom to lobby
45dB	50dB	55dB	Office to office
40dB	45dB	50dB	Office to general area
45dB	50dB	55dB	Office to conference room
45dB	50dB	55dB	Office to washroom
40dB	45dB	50dB	Conference room to general area
40dB	45dB	50dB	Conference room to conference room
45dB	-	-	Classroom to classroom
55dB	-	-	Classroom to shop
45dB	-	-	Classroom to recreation area
60dB	-	-	Classroom to music room

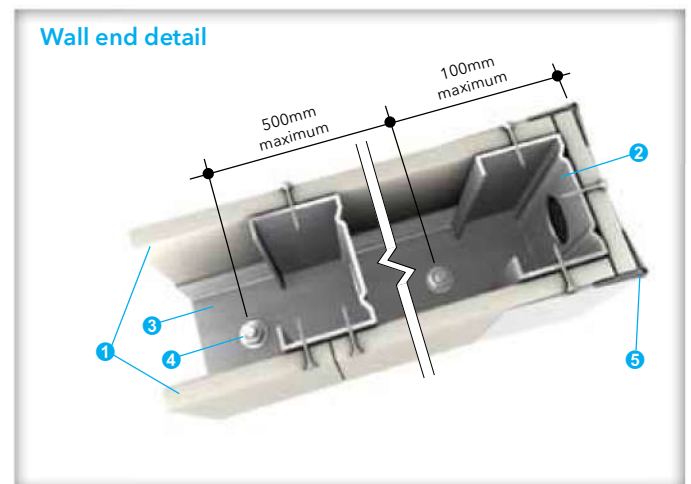
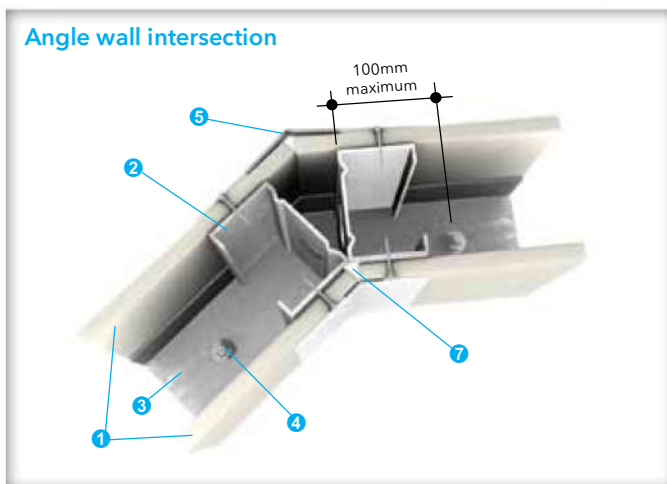
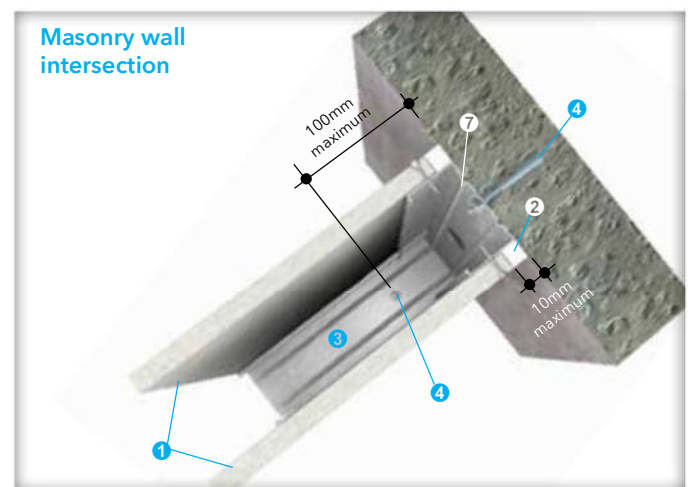
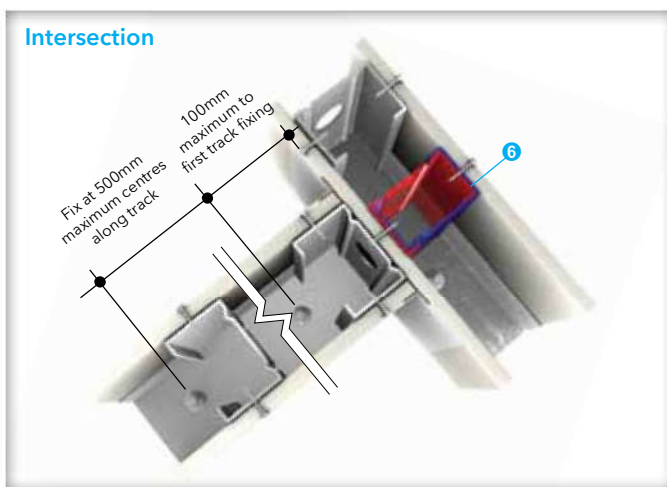
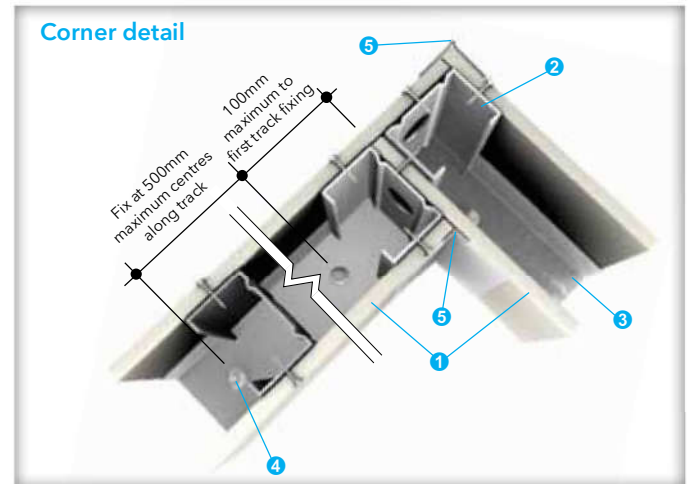
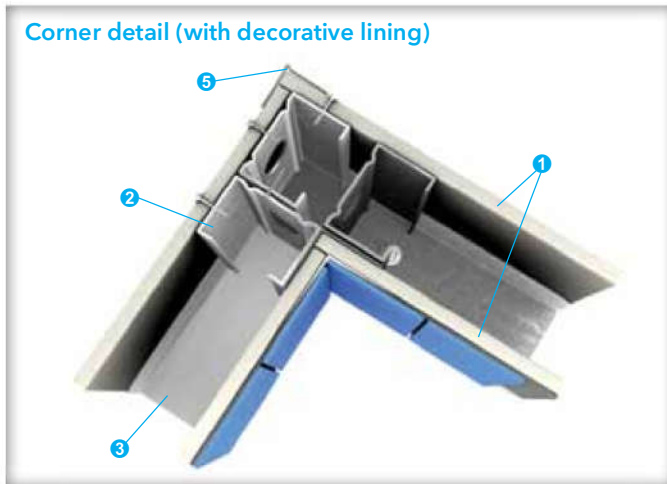

- ① PROMATECT® 100 board
- ② Steel stud at 600mm centres
- ③ Floor track
- ④ 40mm long M6 expansion bolts at 500mm centres
- ⑤ Set corner with tape and jointing compound
- ⑥ Boxed stud at wall intersection

- ⑦ Caulk all perimeter gaps with PROMASEAL®-A Acrylic Sealant to achieve the required fire resistance and/or acoustic performance

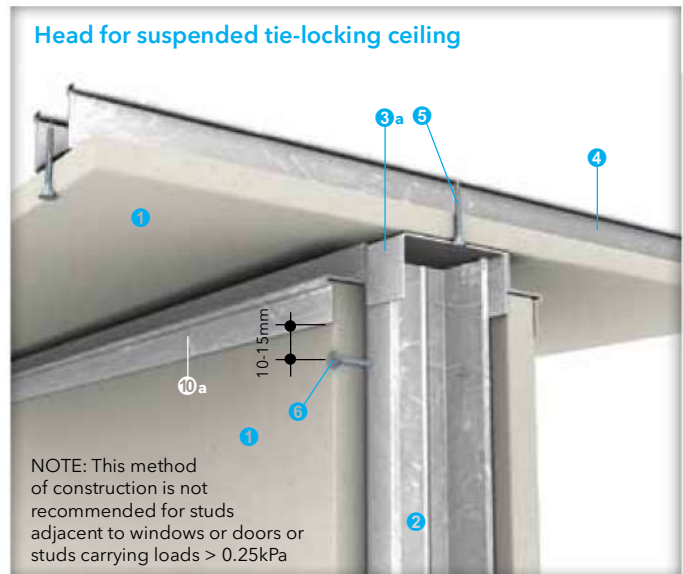
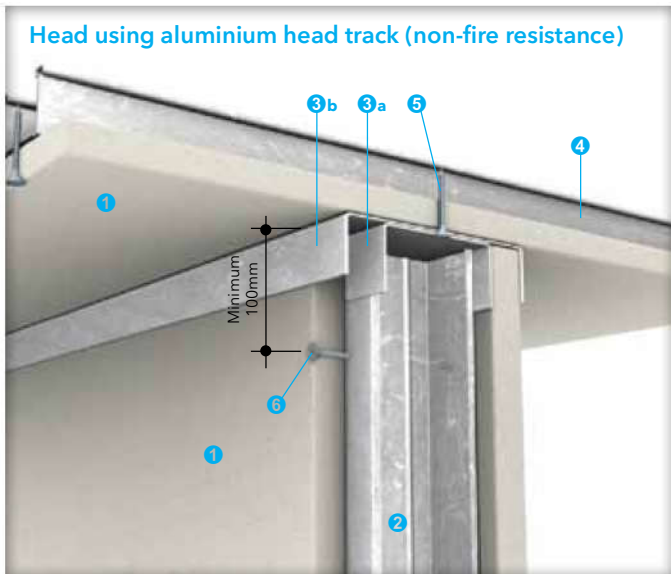
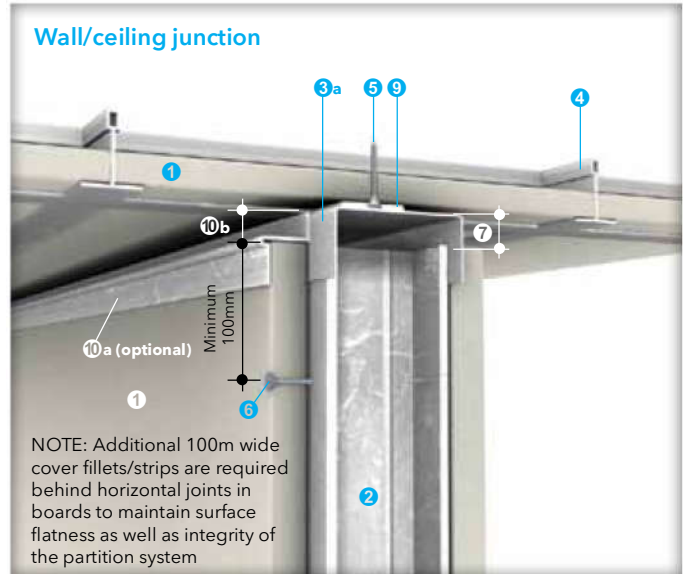
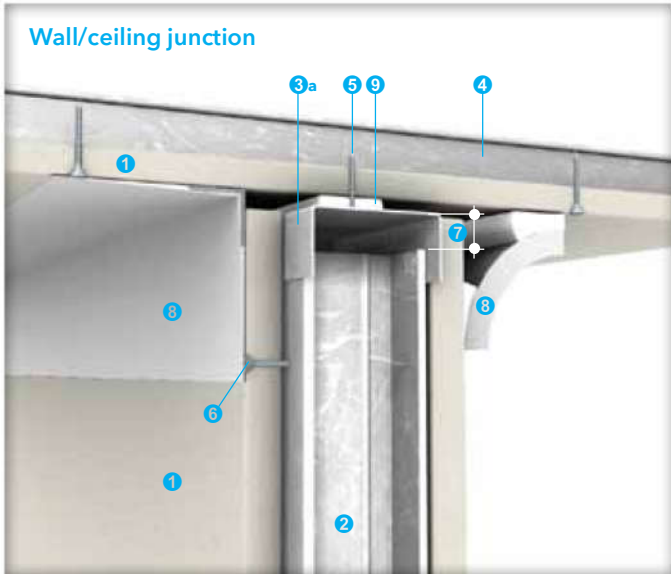

- 1 PROMATECT® 100 board
- 2 Steel stud at 600mm centres
- 3a Top track with leg length minimum 35mm to act as deflection head to accommodate vertical movement
- 3b Extruded aluminium track for 64, 76 or 92mm studs
- 4 Concealed ceiling framing
- 5 Fix top track to channel at maximum 600mm centres to ceiling framing
- 6 No. 6 drywall screws at nominal 200mm centres
- 7 Clearance minimum 8mm (for 3000mm high partition) to allow for expansion under fire conditions
- 8 Tape or cornice finishing based on requirement for aesthetic appearance
- 9 Apply sealant, e.g. PROMASEAL®-A Acrylic Sealant, above track and fix wall track to ceiling framing
- 10a Finishing bead to protect board edge from damage due to construction of ceiling and fixing of accessories such as lighting, etc
- 10b (Optional) Allow minimum 8mm clearance to accommodate adjustment. Fixing should start at minimum 100mm from corner edge to prevent unnecessary breakage

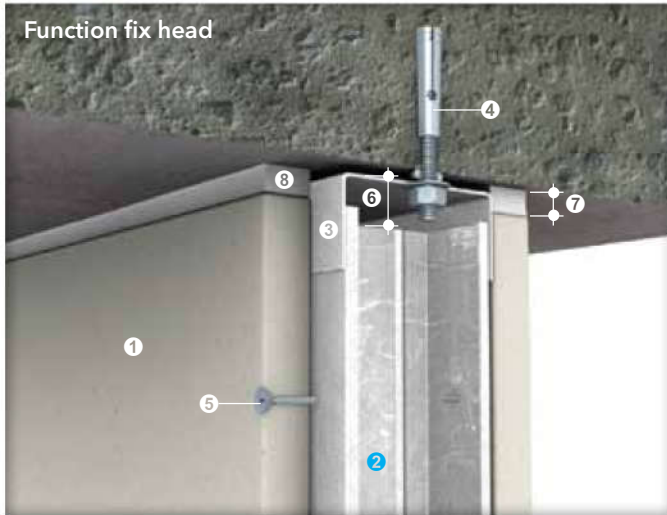

- ① PROMATECT® 100 board
- ② Steel stud at 600mm centres
- ③ Top track with minimum leg length 35mm is fixed in place by anchor bolts. Depth of track dependant upon performance requirement and partition height
- ④ Anchor bolts with minimum 40mm penetration to concrete substrate at maximum 500mm centres
- ⑤ No. 6 drywall screws at nominal 200mm centres

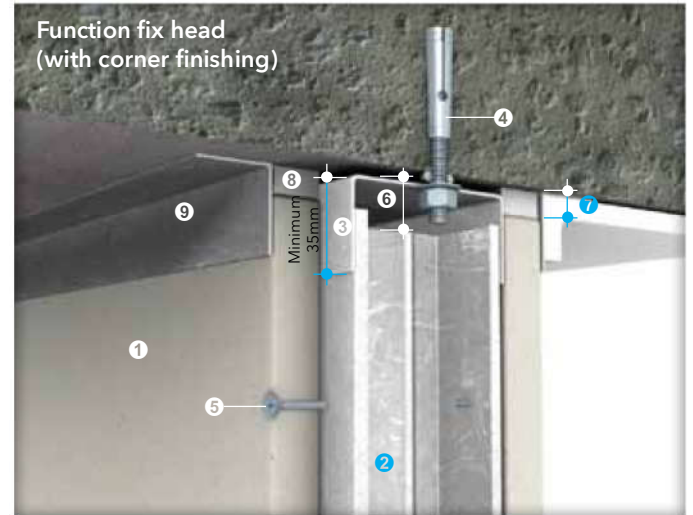

- ⑥ Minimum 6 - 8mm clearance at wall head to allow vertical expansion of steel studs
- ⑦ Allow maximum 5mm clearance between board edge and concrete soffit to accommodate structural movement, if any gap is to be sealed with PROMASEAL®-A Acrylic Sealant
- ⑧ PROMASEAL®-A Acrylic Sealant to fill gap and act as an isolator to limit sound transmission in acoustical wall construction
- ⑨ Corner finishing, e.g. tape, cornice, angle etc. dependant upon requirement of aesthetic appearance

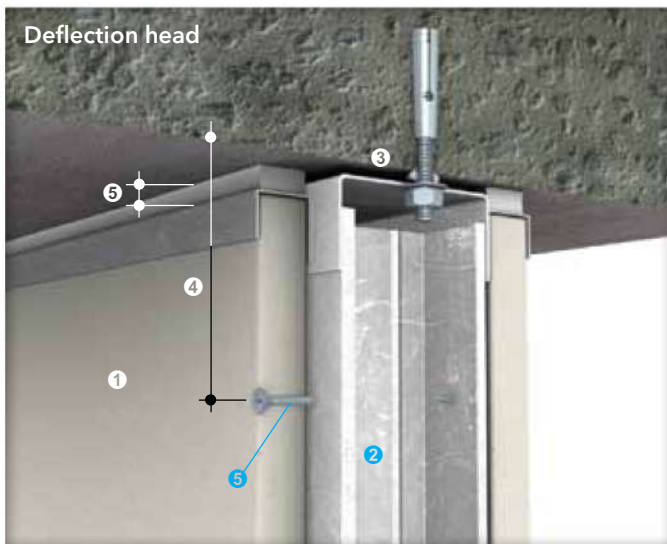

- ① PROMATECT® 100 board
- ② Steel stud at 600mm centres
- ③ Anchor bolts with minimum 40mm penetration into concrete substrate at maximum 500mm centres. For acoustic wall installation if concrete surface is uneven, apply a bead of PROMASEAL®-A Acrylic Sealant between the top track and concrete substrate to seal possible gaps
- ④ Fixing start 100mm from corner edge to avoid possible breakage under structural movement. NOTE: Should be taken that screw fixing does not fix through the track

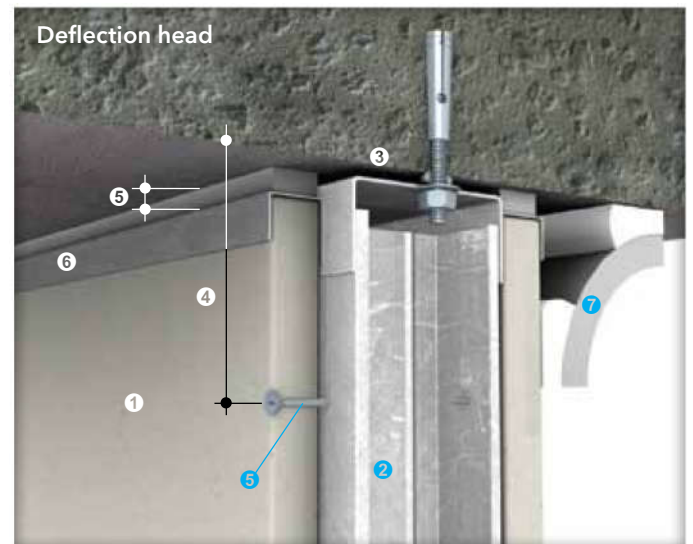

- ⑤ Allow maximum 20mm gap to accommodate vertical movement of structure. Gap is to be filled with flexible sealant such as PROMASEAL®-A Acrylic Sealant in order to optimize integrity of partition
- ⑥ Edge finishing (optional) based upon performance requirement to protect edge from damage
- ⑦ (Optional) Corner finishing, e.g. cornice based upon aesthetic requirement

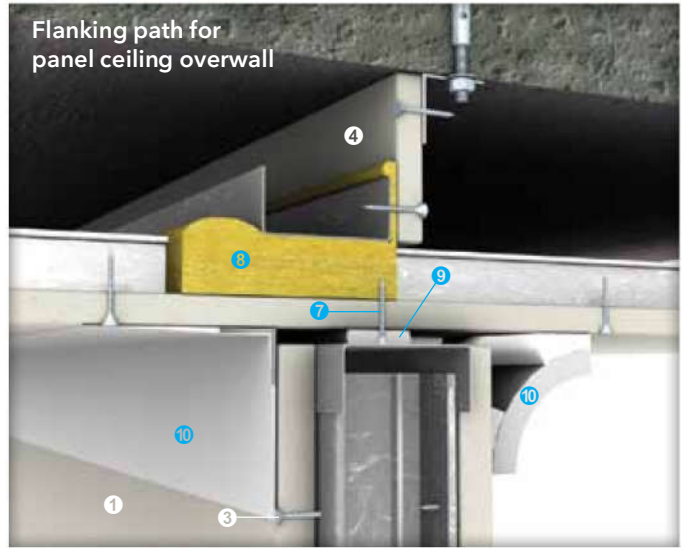
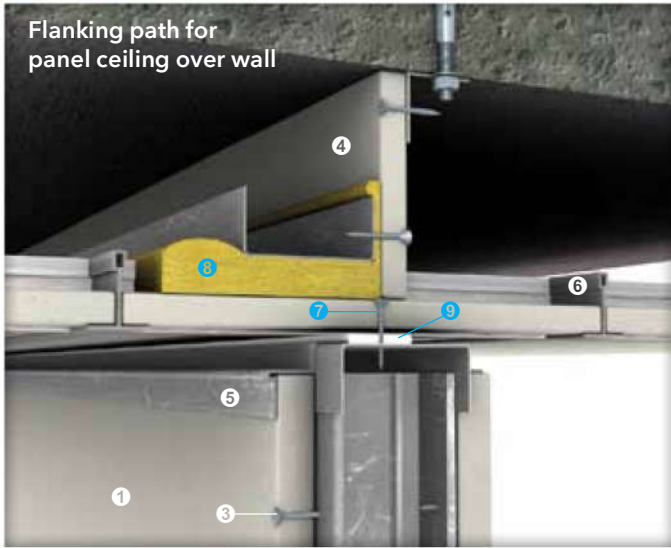

- ① PROMATECT® 100 board
- ② Use of anchor bolts at maximum 500mm centres to secure continuous angles to concrete soffit
- ③ No. 6 drywall screws at nominal 200mm centres length dependant upon board thickness
- ④ Minimum 12mm thick PROMATECT® 100 board runs over wall continuously and fixed to soffit. Joints should be backed by strips of 100mm wide PROMATECT® 100 board of similar thickness
- ⑤ Finishing head to protect board edge from damage due to ceiling construction and fixing of accessories such as lighting etc

- ⑥ Exposed grid framing system. NOTE: Due to large number of joints in ceiling construction, not recommended where high performance acoustic rating required
- ⑦ Ceiling panel screw fixed to wall track to secure in position
- ⑧ Minimum 50mm thick glass wool or equivalent sound absorbing material held in place with track or angle, should be continuous to minimize sound leakage
- ⑨ Bead of PROMASEAL®-A Acrylic Sealant isolator between top track and ceiling panel to reduce conduction of sound frequencies
- ⑩ Tape or cornice finishing based upon requirement of aesthetic appearance

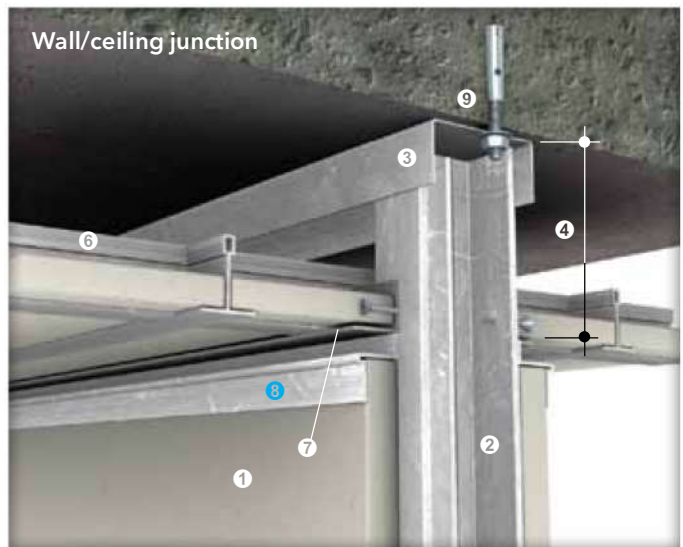

- ① PROMATECT® 100 board
- ② Steel stud at 600mm centres
- ③ Top track with minimum 35mm leg length fixed to concrete soffit using anchor bolts with minimum 40mm penetration to concrete substrate maximum spacing 500mm centres
- ④ Fixing point is minimum 100mm from corner edge of board to avoid unnecessary damage due to structure movement. Use No. 6 drywall screws
- ⑤ Set corner with tape and set or cornice finish

- ⑥ Ceiling framing, suspended from concrete soffit
- ⑦ Perimeter angle fixed to steel studs of partition wall to receive ceiling panels
- ⑧ Finishing bead to protect board edge from damage and for aesthetic appearance
- ⑨ Anchor bolts fixed to concrete substrate at maximum 500mm centres. For acoustic wall installation if concrete surface is uneven, apply a bead of PROMASEAL®-A Acrylic Sealant between the top track and concrete substrate to seal possible gap

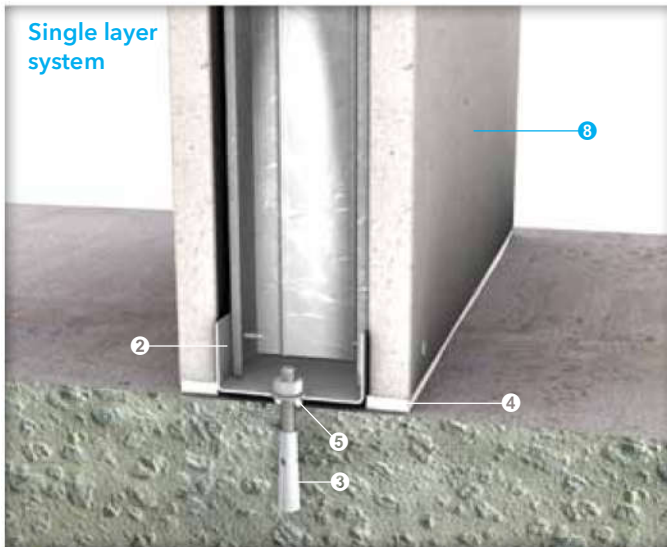

- 1 PROMATECT® 100 board
- 2 Bottom track
- 3 40mm long M6 expansion anchors at 500mm centres

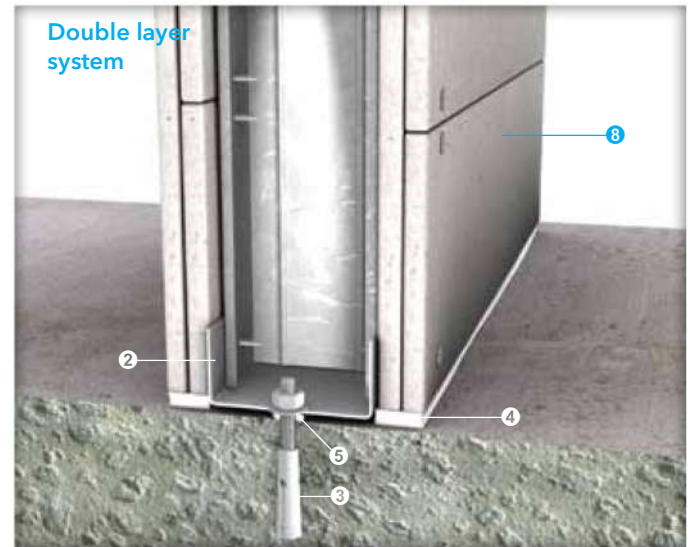

- 4 Caulk all perimeter gaps with PROMASEAL®-A Acrylic Sealant to achieve stated fire and/or acoustic performance
- 5 Continuous bead of PROMASEAL®-A Acrylic Sealant for acoustic integrity

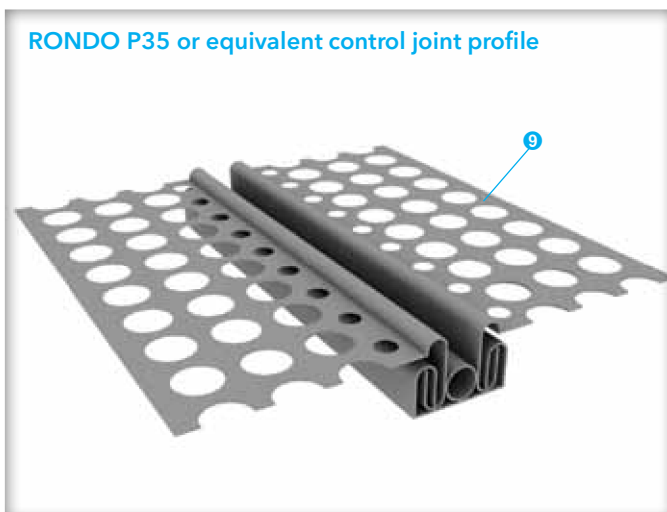
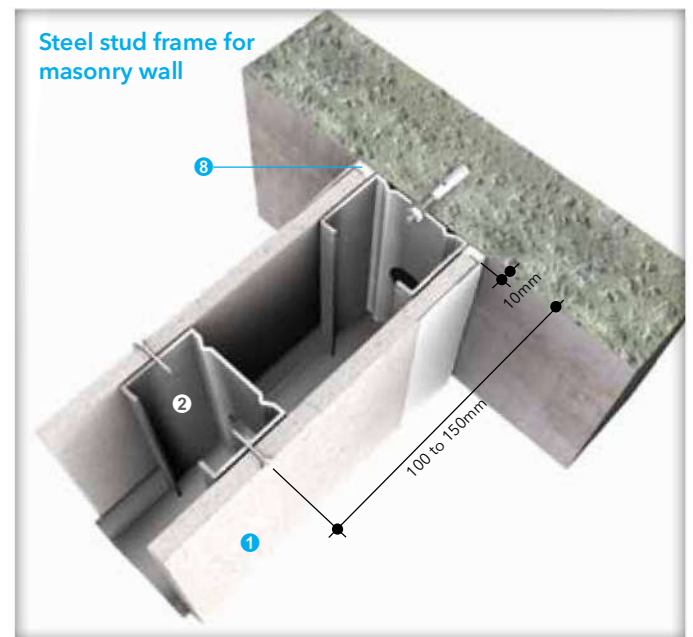
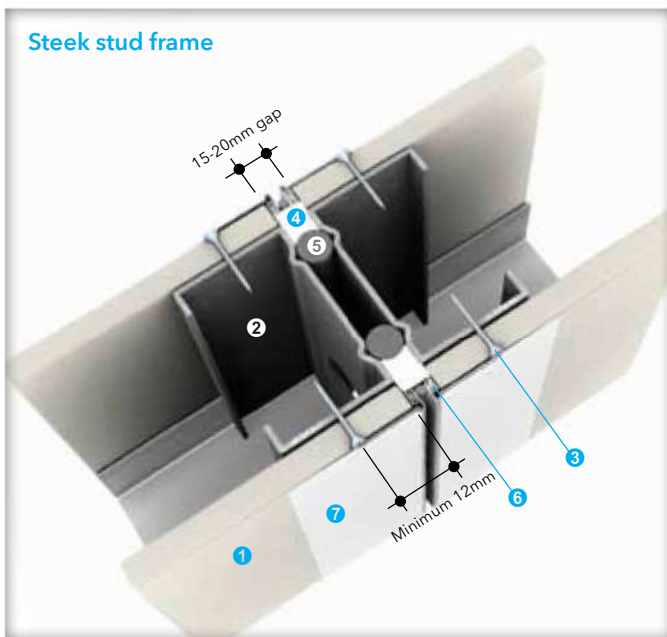

- 1 PROMATECT® 100 board
- 2 Steel studs at maximum 600mm centres
- 3 Fixing point is minimum 100mm from corner edge of board to avoid unnecessary damage due to structural movement. Use No. 6 drywall screws
- 4 PROMASEAL®-A Acrylic Sealant
- 5 Backing rod
- 6 RONDO P35 or equivalent control joint profile
- 7 Finish surface as per external angles
- 8 Caulk all perimeter gaps with PROMASEAL®-A Acrylic Sealant to achieve the required fire resistance and/or acoustic performance
- 9 Perforated locating wing

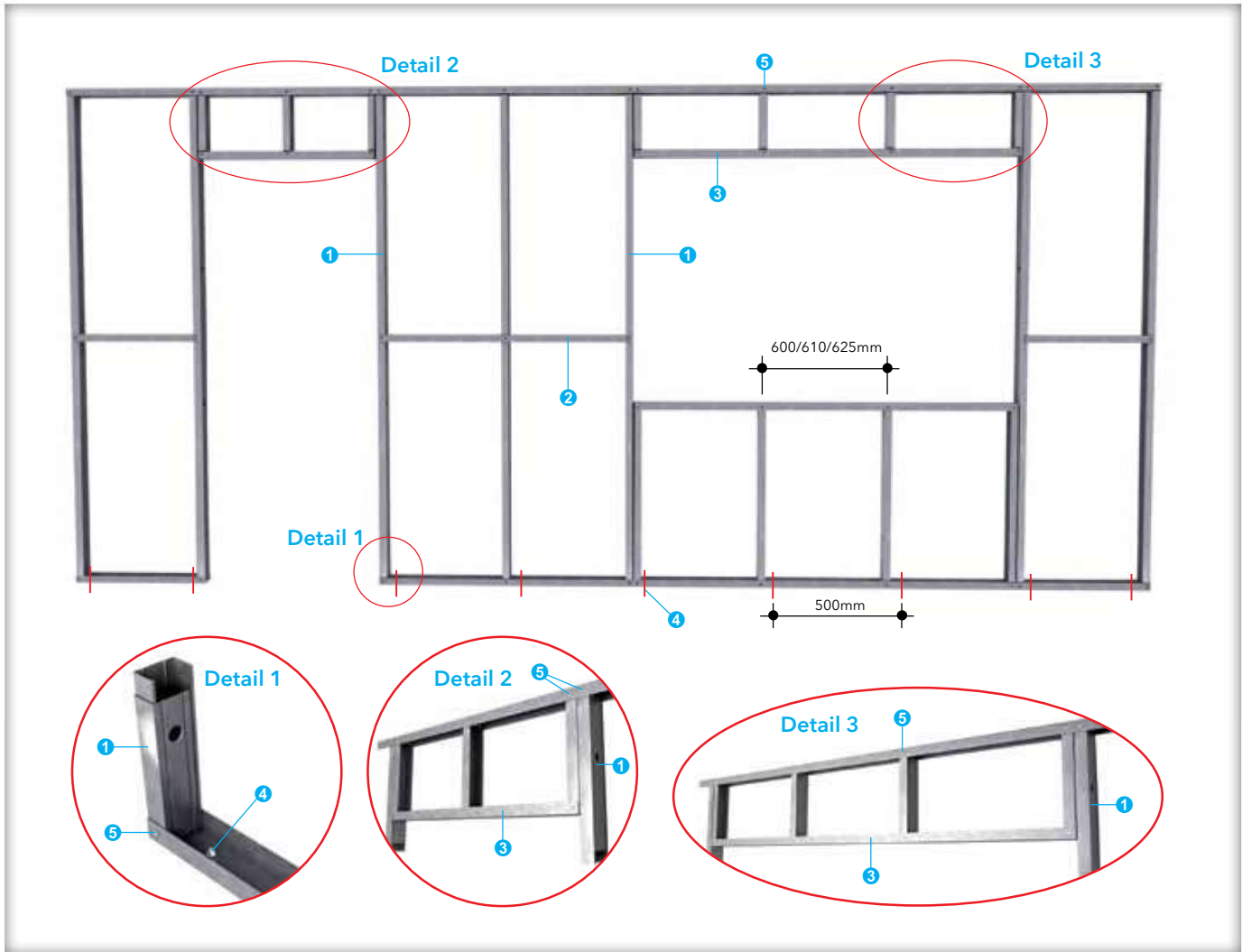

- ① Boxed studs either side of openings, the studs need to be fixed rigidly top and bottom
- ② Horizontal noggings
- ③ Stud track
- ④ Expansion bolt at 600mm centres
- ⑤ No.8 wafer head screws 16mm long or 3mm steel pop rivets

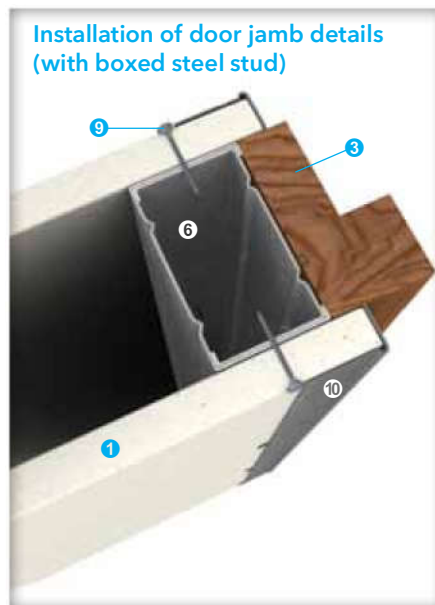
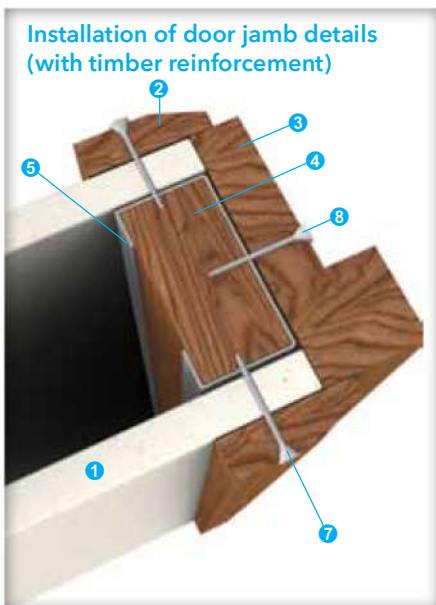

- ① PROMATECT® 100 board
- ② Timber architrave
- ③ Timber door jamb
- ④ Timber studs as reinforcement
- ⑤ Steel stud
- ⑥ Steel stud boxed
- ⑦ Screw fixing (nominal 300mm centres)
- ⑧ Screw fixing (nominal 500mm centres)
- ⑨ Screw fixing (nominal 200mm centres)
- ⑩ Edge metal profile

Planned and unplanned loads

PROMATECT® 100 drywalls facilitate easy fixing of most type of loads or fixtures which can be attached either pre or post installation of the PROMATECT® 100 drywall system. The basic concept is that the support or special fixers/fasteners to be used will also employ the support of the framework of the drywall system. A wide range of propriety expanding fasteners are readily available to fix any load onto a PROMATECT® 100 wall or partition system. Use fasteners in accordance with to the manufacturer's recommendations.

Details for planned and unplanned loads on PROMATECT® 100 drywalls.

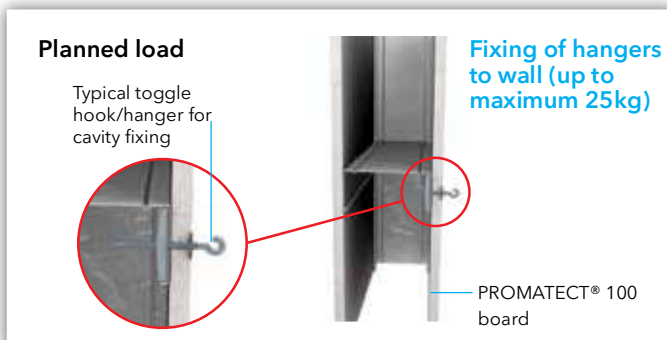
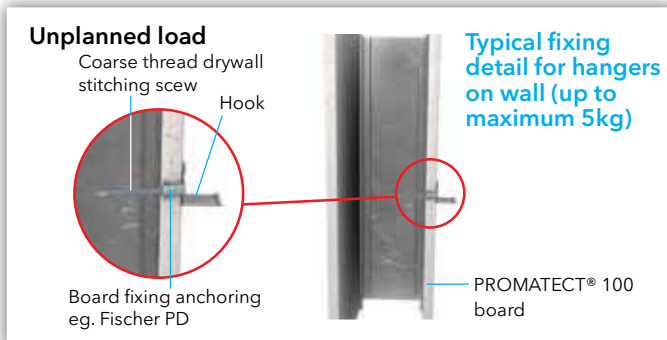

Positioning fixtures and accessories

Most types of wall hangings such as wash basins, kitchen cabinets and shelving etc can easily be installed to PROMATECT® 100 walls or partition systems.

Typical technical details include the following:

- Planned loads up to 25kg (e.g. cabinets and wash basins) can be easily added by fixing horizontal noggins made of timber members at the desired location and securing to the steel stud frame.
- Unplanned loads up to 5kg (e.g. hanging picture frames, for example) can be added by inserting the screw or cavity fixture inclined downward at the appropriate angle, as shown above.
- For planned loads up to 25kg, horizontal noggins can be fixed to the surface of the board, via two additional studs and fixing the load to the strengthening horizontal noggin.
- Fittings and fixtures such as lights and switches are easily fixed to PROMATECT® 100 drywalls. Please refer to [page 79](#) for the recommendations.
- The fitting of toilet fixtures within PROMATECT® 100 wall or partition systems are fully outlined in the recommendations on [page 74](#).

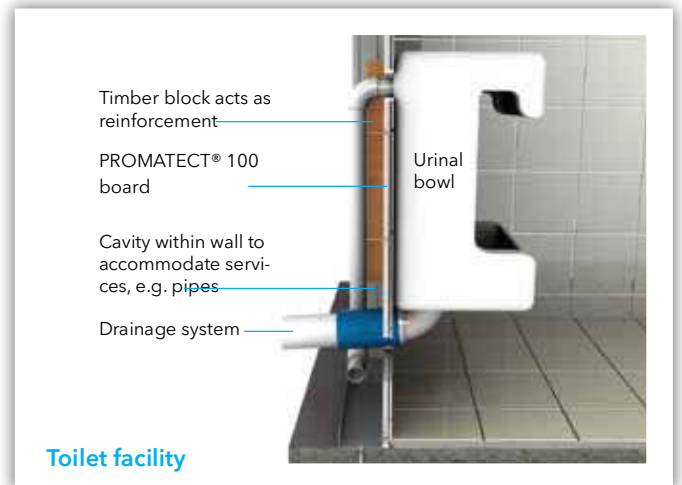
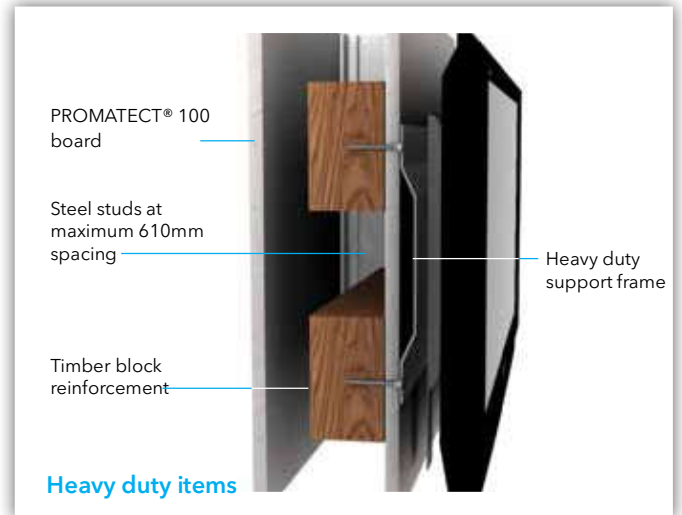

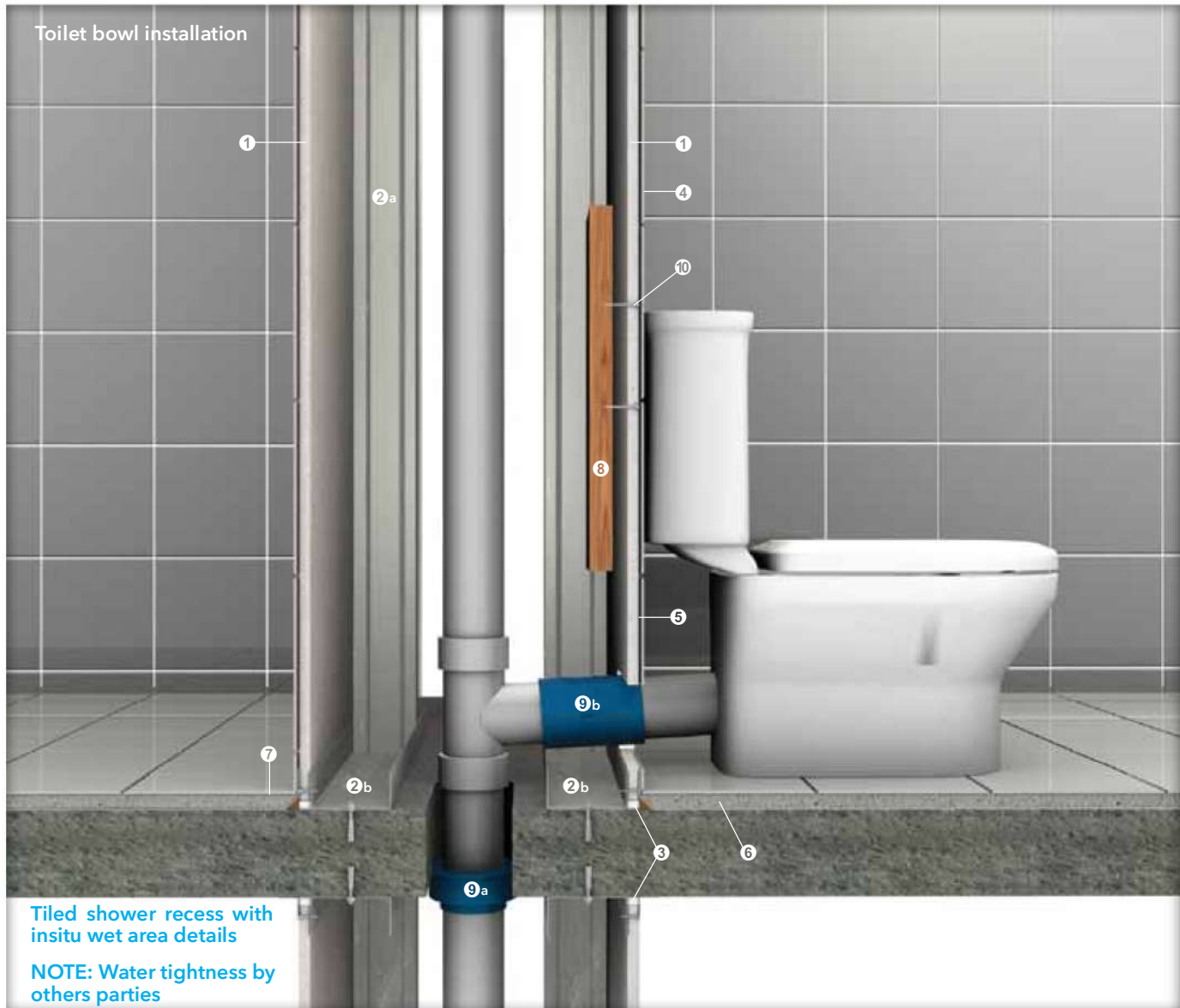

- ❶ PROMATECT® 100 board with thickness dependant upon performance requirement
- ❷ Approved flashing when required by building regulation to prevent water egress
- ❸ PROMASEAL®-A Acrylic Sealant is used to fill gap and seal joints whenever necessary to maintain integrity of wall system
- ❹ Decorative lining onto PROMATECT® 100 board
NOTE: Installation procedures of decorative lining should be strictly in accordance with the recommendation of manufacturer/supplier
- ❺ Insitu internal membrane applied to face of wall lining to prevent moisture related problems
- ❻ Mortar bed prepared according to manufacturer specification to receive floor finishing e.g. tiles, etc
- ❼ Steel studs, spaced at maximum 600mm centres. Studs size dependant upon performance requirement and partition height
- ❽ Reinforcement material, e.g. timber plate, etc. of minimum 9mm thick to support loading
- ❾ Waste pipe made of PVC, uPVC etc. protected by PROMASEAL® FC or FCS retrofit collar to maintain compartmentation during fire conditions. For option of collars please consult Promat
- ❿ No. 6 drywall screws fixed at maximum 200mm centres length depends upon board thickness used
- Ⓜ Top and bottom tracks fixed to concrete substrate using anchor bolts at maximum 500mm centres. For top track, use track with minimum 35mm leg length to accommodate vertical movement of structure
- Ⓨ Plastic pipe, e.g. uPVC or PVC connection to main waste pipe protected with PROMASEAL® FCW wall collar for fire resistance application

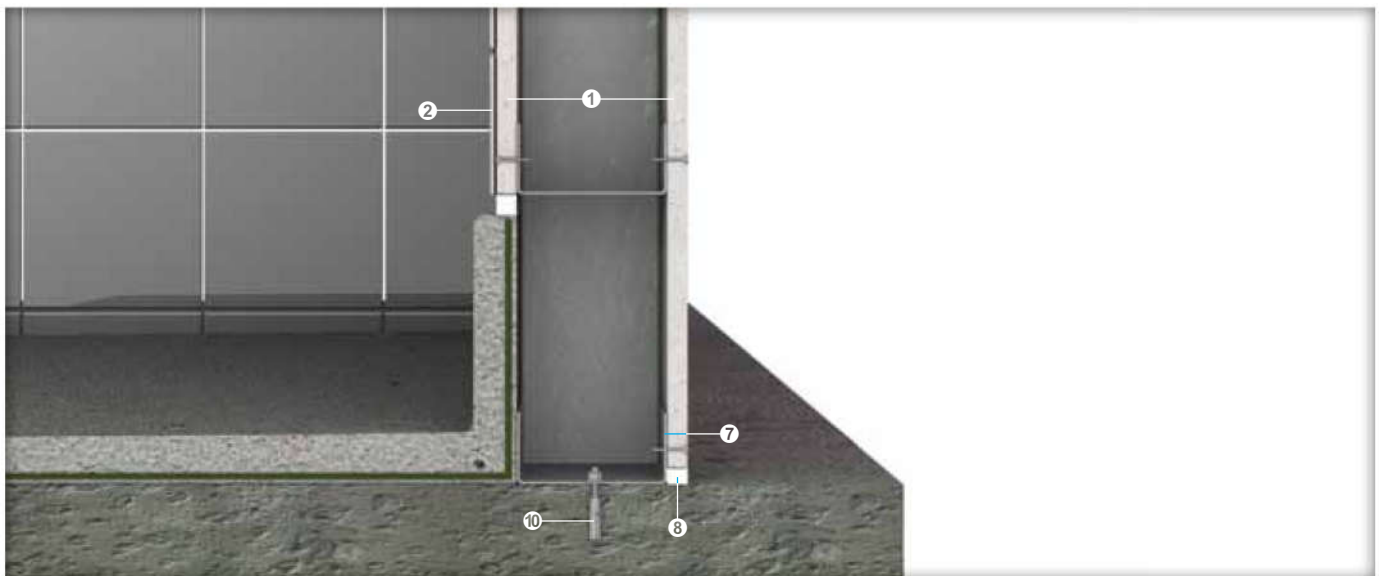

- ① PROMATECT® 100 board with thickness dependant upon performance requirement
- ② Decorative lining, e.g. ceramic or stone tiles
- ③ Use adhesive to install decorative lining. Type of adhesive and application should strictly follow manufacturers recommendations
- ④ Use of flashing tape to prevent water ingress
- ⑤ Bath tub specified by architect or designer. Installation to be carried out according to manufacturer specification
- ⑥ Supporting batten fixed to wall framing using appropriate screw fixing to secure bath tub in position
- ⑦ Bottom track
- ⑧ PROMASEAL®-A Acrylic Sealant
- ⑨ Maximum 6mm gap is allow to accommodate fixing of bath tub. Any gap thereafter should be properly sealed with appropriate flexible sealant
- ⑩ Anchor bolts bolts at maximum 500mm centres

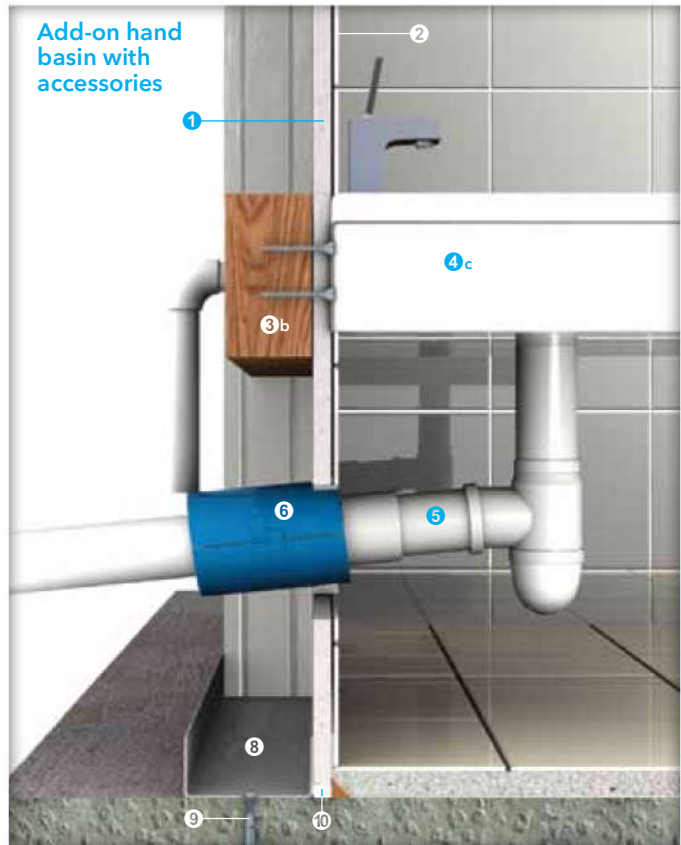
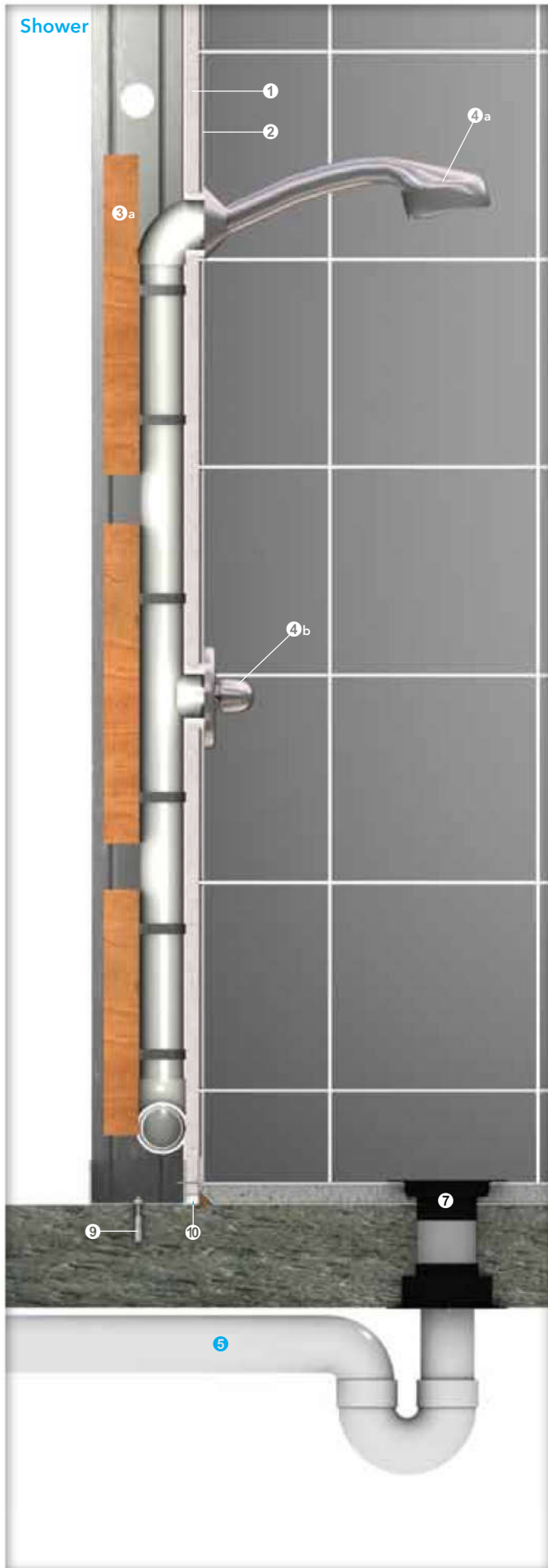

- ① PROMATECT® 100 board with thickness dependant upon performance requirement
- ② Decorative lining, e.g. ceramic or stone tiles
- ③a Timber reinforcement
- ③b Timber block fixed between steel studs acting as reinforcement to support loading from basin fixture
- ④a Typical shower head (with/without handle) as specified by architect or designer
- ④b Knob to control water inlet. This is specified by architect or designer
- ④c Basin as specified by architect or designer
- ⑤ Water waste pipe, e.g. uPVC, etc. connecting to main sewage system
- ⑥ For fire protection application; PROMASEAL® FCW wall collar can be used to prevent fire spread through opening or gap. In cases where waste pipe penetrates floor slab, PROMASEAL® FC or FCS retrofit collar system may be used instead. For other option please consult Promat
- ⑦ PromaSnap® floor waste collar
- ⑧ Bottom track
- ⑨ Anchor bolt to concrete substrate
- ⑩ PROMASEAL®-A Acrylic Sealant

Typical framing details for water tap support and penetrations

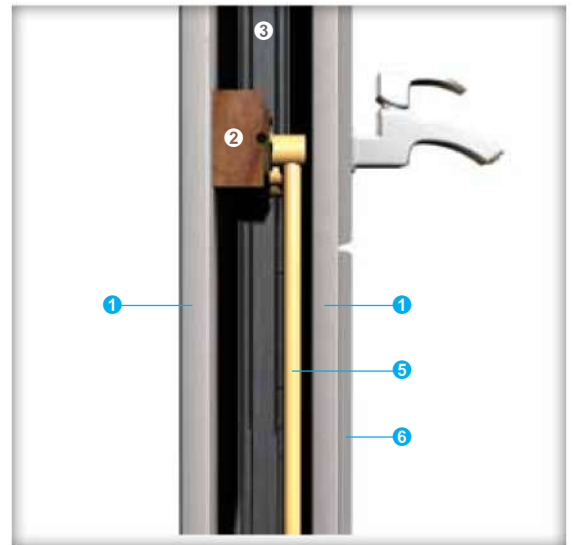

- ① PROMATECT® or PROMINA® board with thickness dependant upon performance requirement
- ② Timber supporting battern
- ③ Steel stud
- ④ PROMASEAL® A Sealant for copper and steel pipes. Use PROMASEAL® Intumescent pipe collars for plastic pipes greater than 25mm in diameter
- ⑤ uPVC or PVC or copper or steel pipework
- ⑥ Ceramic tiles

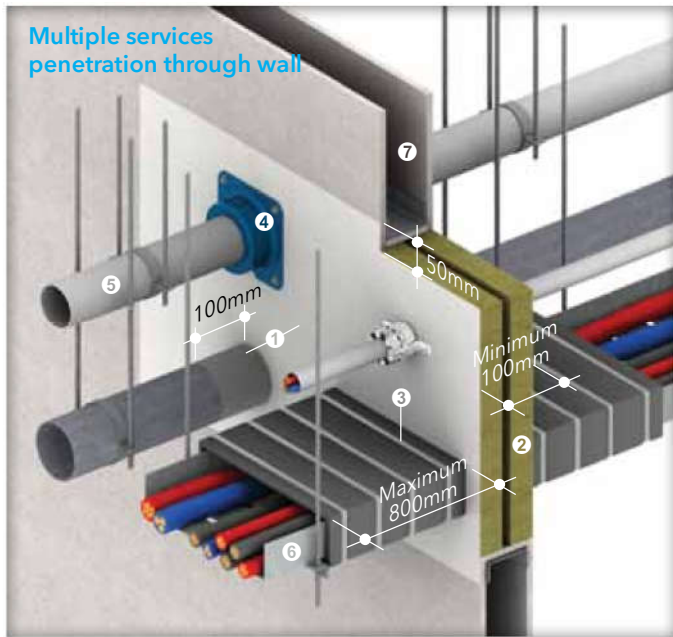

- 1 PROMASEAL® Bulkhead Sealer coating (or PROMASEAL®-A Acrylic Sealant), with minimum 100mm length of coating on the penetrating elements measured from the openings
- 2 One layer of mineral wool 50mm thick x 120kg/m³ for up to -/120/90 fire resistance or two layers of PROMASEAL® Bulkhead batten 50mm thick x minimum 120kg/m³ for up to -/120/120 fire resistance
- 3 PROMASEAL® Wrap
- 4 PROMASEAL® Retrofit Collar (square base) fixed through the batt with a threaded rod
- 5 Non combustibile plastic pipes with appropriate support within 300mm from both sides of the Bulkhead barrier
- 6 Electrical cables supported with cable tray or steel trunking within 300mm from both sides of the Bulkhead barrier
- 7 Fire resistant concrete or masonry walls

PROMASEAL®-A Acrylic Sealant (not shown above) should be liberally applied to all joints and contact points between the Bulkhead barrier and items 3 or 5 AND between the barrier and the floor

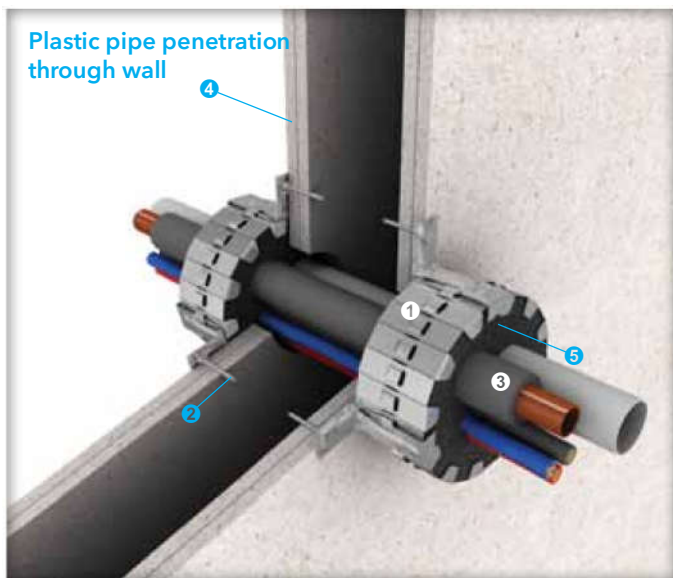

- 1 PROMASTOP® UniCollar®
- 2 Suitable fixing, i.e. laminating screws for lightweight partitions OR steel bolt anchors for masonry/concrete floors
- 3 Various building services, e.g. electrical cables, plastic (uPVC or PEX) pipes and/or insulated copper pipes
- 4 Fire resistance lightweight partitions
- 5 All gaps between collars and services filled with PROMASEAL® Grafitex



- 1 One or two layers of PROMATECT® 100 boards, maximum size 700mm x 700mm
- 2 PROMATECT® 100 board 50mm thick, fixed to concrete/masonry wall using anchor bolts or 75mm x self-tapping Teks screws steel/timber framed lightweight partition at nominal 200mm centres
- 3 PROMATECT® 100 board 9mm thick
- 4 Hinges
- 5 General building services, e.g. electrical cables, metal pipes etc
- 6 Fire resistant concrete/masonry wall or steel/timber framed lightweight partition

Curtain wall detail

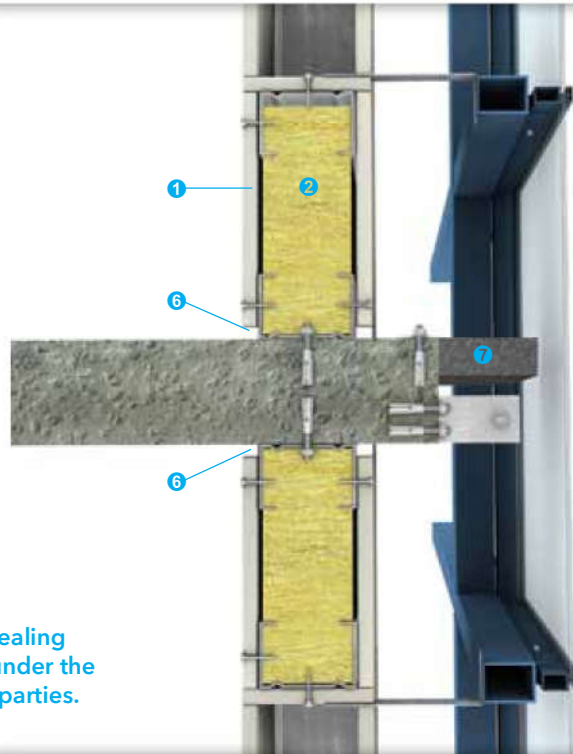

NOTE: Weather tight sealing and structural design under the responsibility of other parties. Please consult Promat

Power outlet/light switch installation

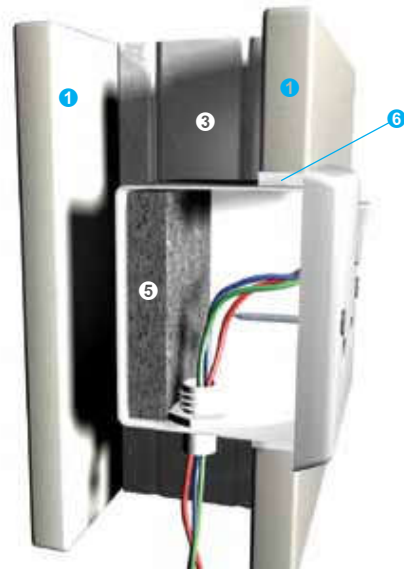
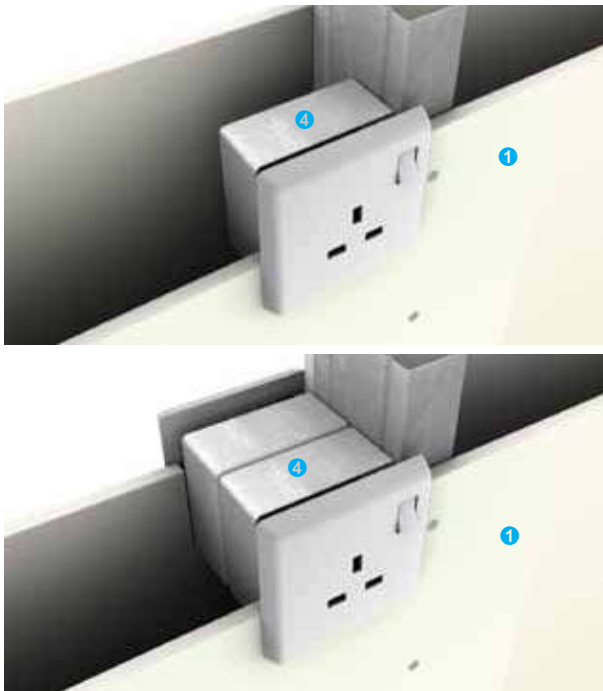

NOTE: For fire resistant walls, steel electrical switch boxes should be employed to avoid degrading fire performance of the wall system

- ① PROMATECT® 100 board with thickness dependant upon performance requirement
- ② Insulation material enhances thermal insulation of building
- ③ Steel studs at maximum 610mm centres. Stud size dependant upon performance requirement and partition height
- ④ Fire resistance switchbox based upon performance. Please consult Promat

- ⑤ PROMASEAL® Switchbox intumescent infill
- ⑥ PROMASEAL®-A Acrylic Sealant is used to seal gap to maintain integrity of partition system
- ⑦ PROMASEAL® Expansion Joint Strip



Fire resistance	FRL	-/60/60
	Standard	AS 1530: Part 4: 2014
	Approval	P106900-1005
Acoustic	STC, R _w	See acoustic table below
	Standard	ISO 140: Part 3: 1996 ISO 717: Part 1: 1996
	Predicted assessment	Marshall Day 13th October 2016
Construction	Maximum height	5000mm
	Maximum length	Unlimited
	Partition thickness	From 94mm
	Partition mass*	From 27kg/m ²

- ① One layer of PROMATECT® 100 board 15mm thick at both sides of steel studs
- ② Galvanised steel studs, measurements in accordance with Studs Tables on page 94 (allow appropriate expansion at top horizontal track, no allowance at this track for loadbearing purposes)
- ③ 25mm long self-tapping screws at maximum 300mm centres
- ④ 40mm long M6 masonry anchors at nominal 500mm centres
- ⑤ Caulk all perimeter gaps with PROMASEAL®-A Acrylic Sealant to achieve the required fire resistance and/or acoustic performance

See page 60 and 61 for bottom and top track fixings; pages 67 to 71 for details of wall head, wall base, wall junction and wall movement joints.

Acoustic Table

Stud depth	64mm	76mm	92mm	150mm
Cavity infill	# STC / R _w (C _r)			
a) Nil	41/40dB (-10)	42/41dB (-10)	42/42dB (-10)	42/44dB (-7)
b) Bradford R2.0 Soundscreen 50mm x 32kg/m ³	46/46dB (-12)	48/47dB (-11)	49/48dB (-11)	50/50dB (-8)
c) Bradford R2.0 Soundscreen 75mm x 32kg/m ³	46/46dB (-12)	48/47dB (-11)	49/48dB (-10)	50/50dB (-8)
d) R1.8 Pink Wall Batts 60mm x 9kg/m ³	45/45dB (-12)	47/46dB (-11)	49/47dB (-11)	50/49dB (-8)

NOTE: Above values are predicted figures. # Margin of error is generally within ±3dB



Fire resistance	FRL	-/120/120
	Standard	AS 1530: Part 4: 2014
	Approval	WFRA 45883 P106900-1005
Acoustic	STC, R _w	See acoustic table below
	Standard	ISO 140: Part 3: 1996 ISO 717: Part 1: 1996
	Predicted assessment	Marshall Day 18th October 2006
Construction	Maximum height*	4000mm
	Maximum length	Unlimited
	Partition thickness	From 104mm
	Partition mass*	From 35kg/m ²

* Details for walls above 8500mm high are available on request

- 1 One layer of PROMATECT® 100 board 20mm thick at both sides of steel studs
- 2 Galvanised steel studs, measurements in accordance with Studs Tables on page 94 (allow appropriate expansion at top horizontal track, no allowance at this track for loadbearing purposes)
- 3 45mm long self-tapping screws at maximum 300mm centres
- 4 40mm long M6 masonry anchors at nominal 500mm centres
- 5 Caulk all perimeter gaps with PROMASEAL®-A Acrylic Sealant to achieve the required fire resistance and/or acoustic performance

See page 60 and 61 for bottom and top track fixings; pages 67 to 71 for details of wall head, wall base, wall junction and wall movement joints.

Acoustic Table

Stud depth	64mm	76mm	92mm	150mm
Cavity infill	# STC / R _w (C _{tr})			
a) Nil	42/43dB (-11)	42/43dB (-9)	42/44dB (-9)	42/46dB (-7)
b) Bradford R2.0 Soundscreen 50mm x 32kg/m ³	48/48dB (-10)	48/49dB (-10)	48/49dB (-8)	48/51dB (-7)
c) Bradford R2.0 Soundscreen 75mm x 32kg/m ³	49/48dB (-10)	49/49dB (-10)	49/50dB (-9)	49/51dB (-7)
d) R1.8 Pink Wall Batts 60mm x 9kg/m ³	48/47dB (-11)	48/48dB (-10)	48/49dB (-9)	48/51dB (-8)

NOTE: Above values are predicted figures. # Margin of error is generally within ±3dB

Vertical sheeting (Below 3000mm) / Non loadbearing and loadbearing

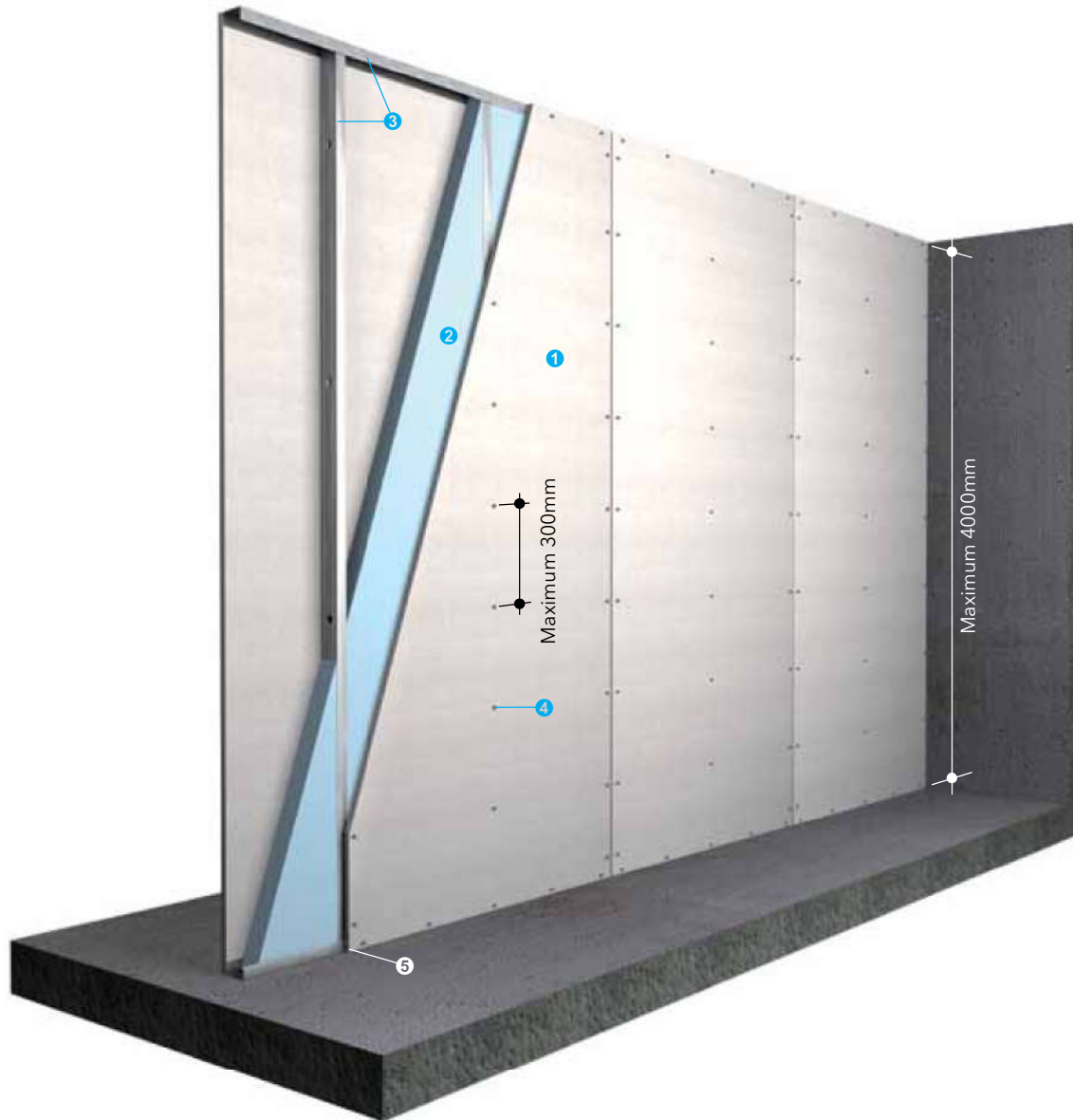

- ① One layer of PROMATECT® 100 board 20mm thick at both sides of steel studs
- ② Cavity infill if required to improve acoustic or thermal insulation
- ③ Galvanised steel studs, measurements in accordance with Studs Tables on page 94 (allow appropriate expansion at top horizontal track)
- ④ 45mm long self-tapping screws at maximum 300mm centres
- ⑤ Caulk all perimeter gaps with PROMASEAL®-A Acrylic Sealant to achieve the required fire resistance and/or acoustic performance

See page 60 and 61 for bottom and top track fixings; pages 67 to 71 for details of wall head, wall base, wall junction and wall movement joints.

Vertical sheeting (Above 3000mm) / Non loadbearing

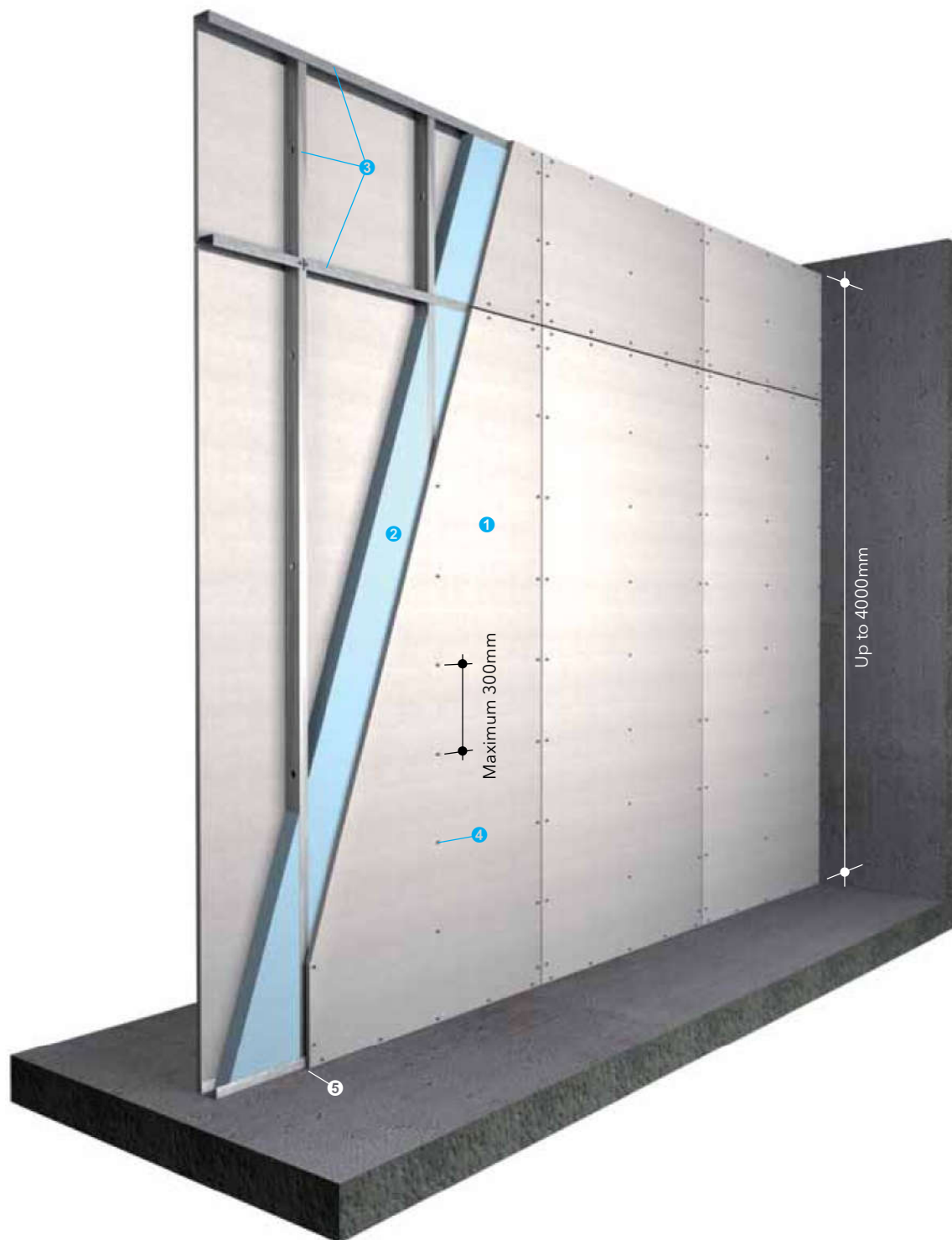

- ① One layer of PROMATECT® 100 board 20mm thick at both sides of steel studs
- ② Cavity infill if required to improve acoustic or thermal insulation
- ③ Galvanised steel studs, measurements in accordance with Studs Tables on [page 94](#) (allow appropriate expansion at top horizontal track)
- ④ 45mm long self-tapping screws at maximum 300mm centres
- ⑤ Caulk all perimeter gaps with PROMASEAL®-A Acrylic Sealant to achieve the required fire resistance and/or acoustic performance

See [page 60 and 61](#) for bottom and top track fixings; [pages 67 to 71](#) for details of wall head, wall base, wall junction and wall movement joints.

Horizontal sheeting with nogging joint / Non loadbearing

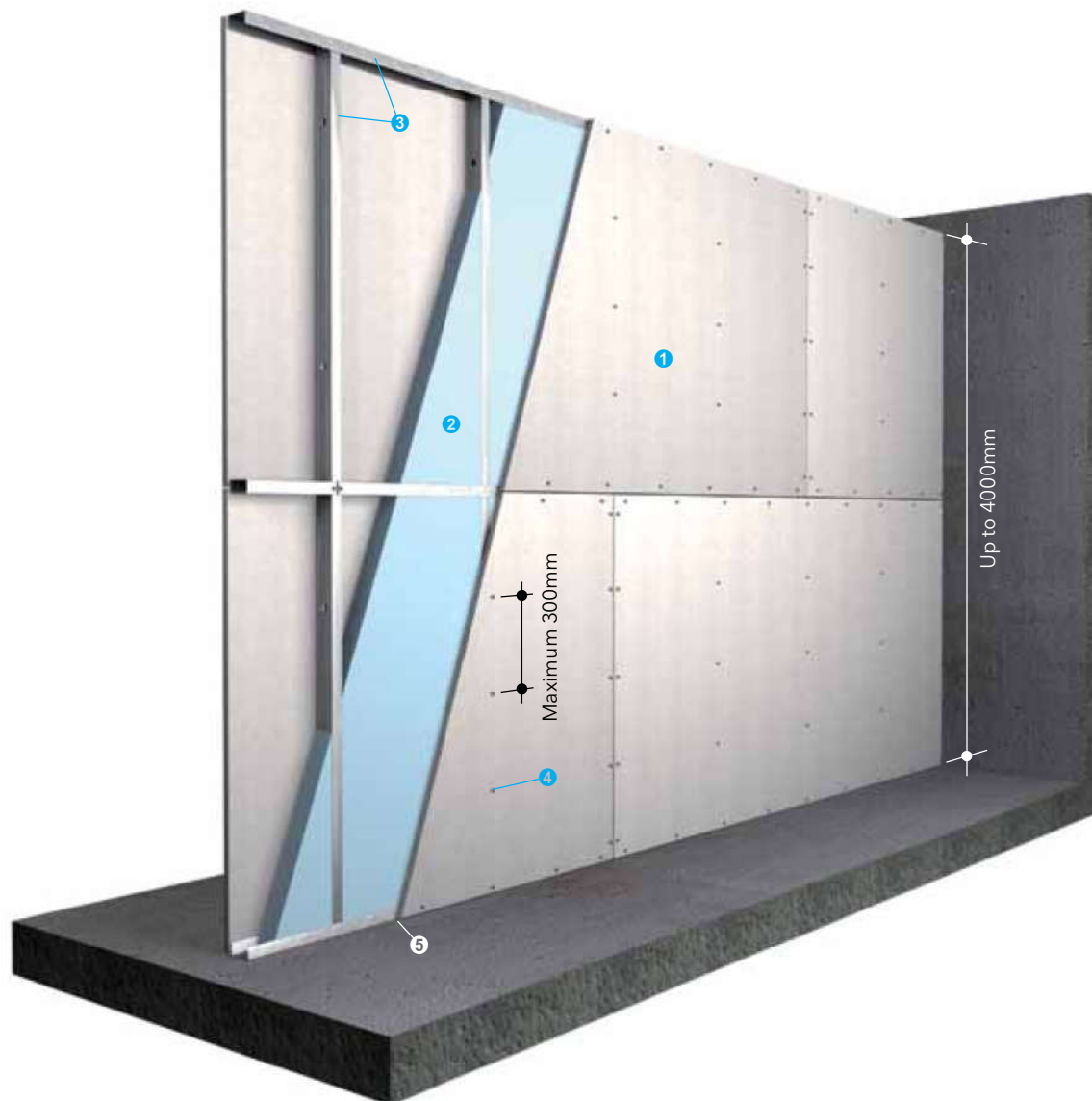

- ❶ One layer of PROMATECT® 100 board 20mm thick at both sides of steel studs
- ❷ Cavity infill if required to improve acoustic or thermal insulation
- ❸ Galvanised steel studs, measurements in accordance with Studs Tables on [page 94](#) (allow appropriate expansion at top horizontal track), refer to table below for the distance between stud
- ❹ 45mm long self-tapping screws at maximum 300mm centres
- ❺ Caulk all perimeter gaps with PROMASEAL®-A Acrylic Sealant to achieve the required fire resistance and/or acoustic performance

See [page 60](#) and [61](#) for bottom and top track fixings; [pages 67](#) to [71](#) for details of wall head, wall base, wall junction and wall movement joints.

Horizontal sheeting with strip joint / Non loadbearing



- ① One layer of PROMATECT® 100 board 20mm thick at both sides of steel studs
- ② Cavity infill if required to improve acoustic or thermal insulation
- ③ Galvanised steel studs, measurements in accordance with Studs Tables on [page 94](#) (allow appropriate expansion at top horizontal track)
- ④ 45mm long self-tapping screws at maximum 300mm centres
- ⑤ Caulk all perimeter gaps with PROMASEAL®-A Acrylic Sealant to achieve the required fire resistance and/or acoustic performance
- ⑥ 20mm thick PROMATECT® 100 cover strips at horizontal board joint

See [page 60 and 61](#) for bottom and top track fixings; [pages 67 to 71](#) for details of wall head, wall base, wall junction and wall movement joints.

Horizontal sheeting with channel joint / Non loadbearing



- ❶ One layer of PROMATECT® 100 board 20mm thick at both sides of steel studs
- ❷ Cavity infill if required to improve acoustic or thermal insulation
- ❸ Galvanised steel studs, measurements in accordance with Studs Tables on [page 94](#) (allow appropriate expansion at top horizontal track)
- ❹ 45mm long self-tapping screws at maximum 300mm centres
- ❺ Caulk all perimeter gaps with PROMASEAL®-A Acrylic Sealant to achieve the required fire resistance and/or acoustic performance
- ❻ Fixing channel 100mm x 10mm x 0.9mm thick

See [page 60 and 61](#) for bottom and top track fixings; [pages 67 to 71](#) for details of wall head, wall base, wall junction and wall movement joints.



Fire resistance	FRL	-/240/240
	Standard	AS 1530: Part 4: 2014
	Approval	BRE P106900-1005
Acoustic	STC, R _w	See acoustic table below
	Standard	ISO 140: Part 3: 1996 ISO 717: Part 1: 1996
	Predicted assessment	Marshall Day 13th October 2016
Construction	Maximum height*	5000mm
	Maximum length	Unlimited
	Partition thickness	From 164mm
	Partition mass*	From 70kg/m ²

- ① Two layer of PROMATECT® 100 board 20mm thick on both sides of steel studs
- ② Galvanised steel studs, measurements in accordance with Studs Tables on page 94 (allow appropriate expansion at top horizontal track)
- ③ 32mm long self-tapping screws at maximum 300mm centres
50mm long self-tapping screws at maximum 200mm centres to fixed second layer to frame
40mm long stitching screws at maximum 200mm centres to fixed second layer to first layer
- ④ 40mm long M10 masonry anchors at nominal 500mm centres
- ⑤ Caulk all perimeter gaps with PROMASEAL®-A Acrylic Sealant to achieve the required fire resistance and/or acoustic performance

See page 60 and 61 for bottom and top track fixings; pages 67 to 71 for details of wall head, wall base, wall junction and wall movement joints.

Acoustic Table

Stud depth	92mm	150mm
Cavity infill	# STC / R _w (C _r)	
a) Nil	53/54dB (-7)	53/55dB (-6)
b) Bradford R2.0 Soundscreen 50mm x 32kg/m ³	55/58dB (-6)	55/59dB (-6)
c) Bradford R2.0 Soundscreen 75mm x 32kg/m ³	55/58dB (-6)	55/59dB (-6)
d) R1.8 Pink Wall Batts 60mm x 9kg/m ³	55/58dB (-6)	55/59dB (-6)

NOTE: Above values are predicted figures. # Margin of error is generally within ±3dB

Vertical sheeting (Below 3000mm) / Non loadbearing

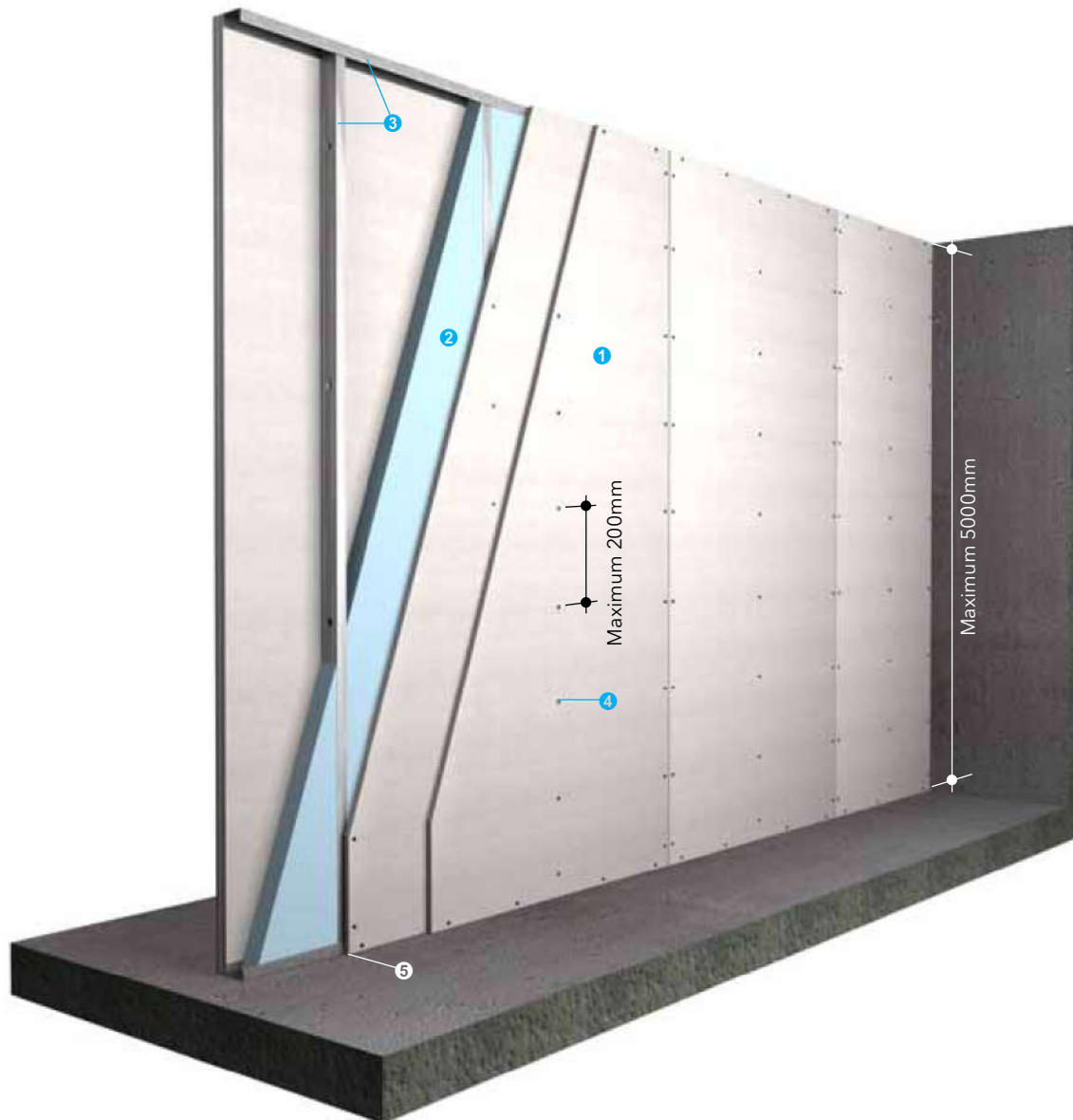

- ① Two layer of PROMATECT® 100 board 20mm thick on both sides of steel studs
- ② Cavity infill if required to improve acoustic or thermal insulation
- ③ Galvanised steel studs, measurements in accordance with Studs Tables on [page 94](#) (allow appropriate expansion at top horizontal track)
- ④ 32mm long self-tapping screws at maximum 300mm centres
50mm long self-tapping screws at maximum 200mm centres to fixed second layer to frame
40mm long stitching screws at maximum 200mm centres to fixed second layer to first layer
- ⑤ Caulk all perimeter gaps with PROMASEAL®-A Acrylic Sealant to achieve the required fire resistance and/or acoustic performance

See [page 60](#) and [61](#) for bottom and top track fixings; [pages 67](#) to [71](#) for details of wall head, wall base, wall junction and wall movement joints.

Vertical sheeting (Above 3000mm) / Non loadbearing

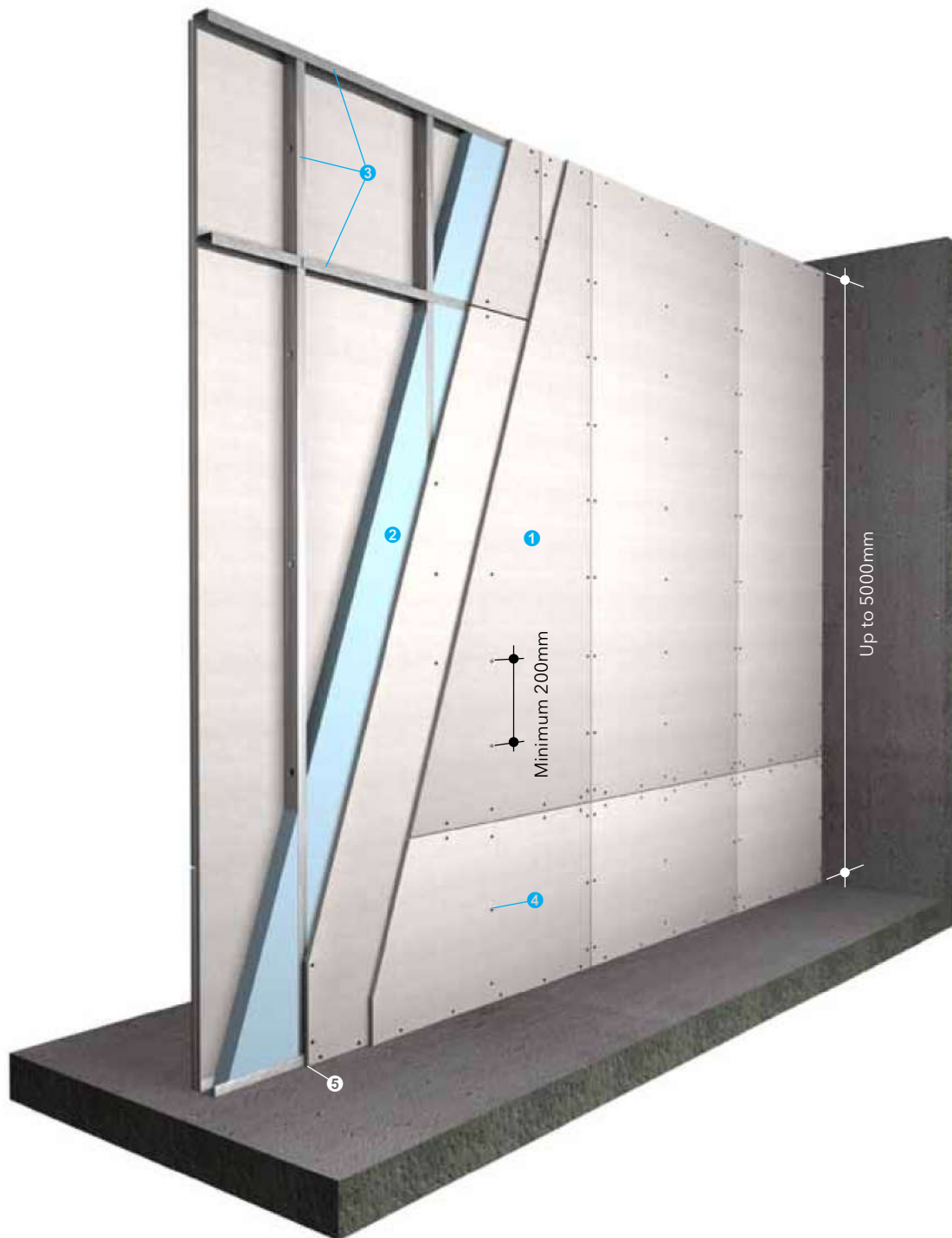

- ① Two layer of PROMATECT® 100 board 20mm thick on both sides of steel studs
- ② Cavity infill if required to improve acoustic or thermal insulation
- ③ Galvanised steel studs, measurements in accordance with Studs Tables on [page 94](#) (allow appropriate expansion at top horizontal track)
- ④ 32mm long self-tapping screws at maximum 300mm centres
50mm long self-tapping screws at maximum 200mm centres to fixed second layer to frame
40mm long stitching screws at maximum 200mm centres to fixed second layer to first layer
- ⑤ Caulk all perimeter gaps with PROMASEAL®-A Acrylic Sealant to achieve the required fire resistance and/or acoustic performance

See [page 60](#) and [61](#) for bottom and top track fixings; [pages 67](#) to [71](#) for details of wall head, wall base, wall junction and wall movement joints.

Horizontal sheeting with nogging joint / Non loadbearing

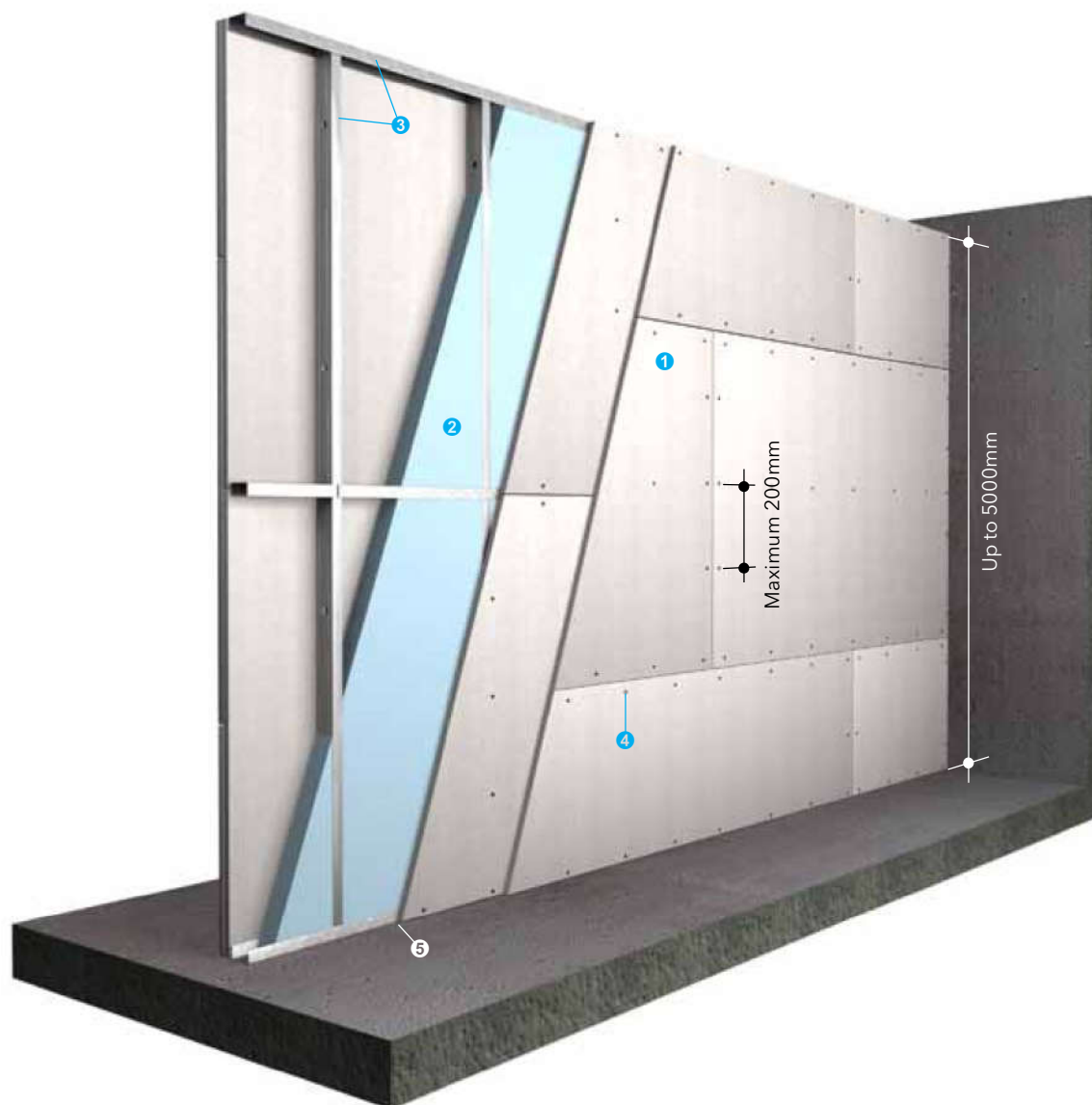

- ❶ Two layer of PROMATECT® 100 board 20mm thick on both sides of steel studs
- ❷ Cavity infill if required to improve acoustic or thermal insulation
- ❸ Galvanised steel studs, measurements in accordance with Studs Tables on [page 94](#) (allow appropriate expansion at top horizontal track), refer to table below for the distance between stud
- ❹ 32mm long self-tapping screws at maximum 300mm centres
50mm long self-tapping screws at maximum 200mm centres to fixed second layer to frame
40mm long stitching screws at maximum 200mm centres to fixed second layer to first layer
- ❺ Caulk all perimeter gaps with PROMASEAL®-A Acrylic Sealant to achieve the required fire resistance and/or acoustic performance

See [page 60](#) and [61](#) for bottom and top track fixings; [pages 67](#) to [71](#) for details of wall head, wall base, wall junction and wall movement joints.

Horizontal sheeting with strip joint / Non loadbearing

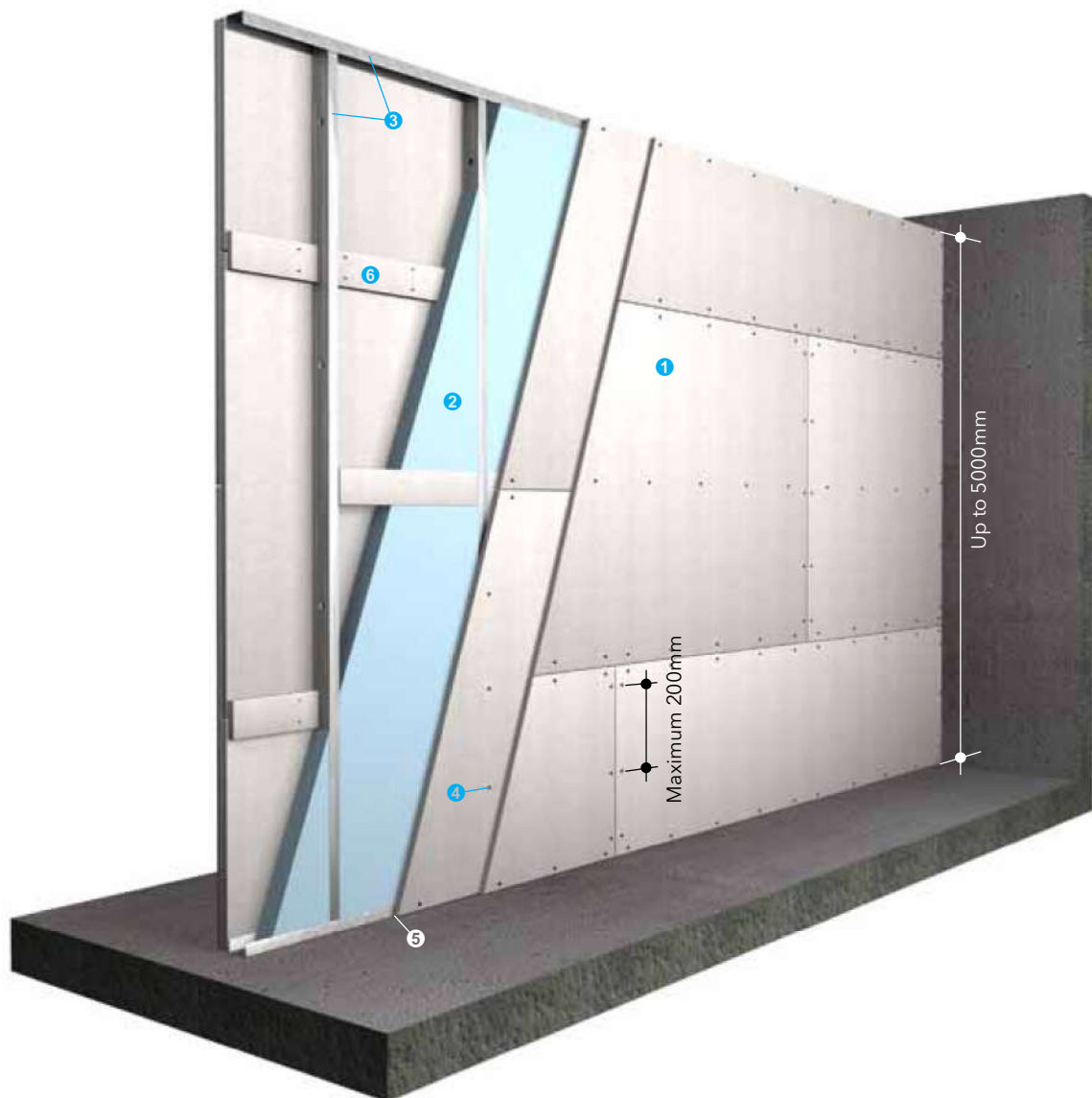

- ① Two layer of PROMATECT® 100 board 20mm thick on both sides of steel studs
- ② Cavity infill if required to improve acoustic or thermal insulation
- ③ Galvanised steel studs, measurements in accordance with Studs Tables on [page 94](#) (allow appropriate expansion at top horizontal track)
- ③ 32mm long self-tapping screws at maximum 300mm centres
50mm long self-tapping screws at maximum 200mm centres to fixed second layer to frame
40mm long stitching screws at maximum 200mm centres to fixed second layer to first layer
- ⑤ Caulk all perimeter gaps with PROMASEAL®-A Acrylic Sealant to achieve the required fire resistance and/or acoustic performance
- ⑥ 20mm thick PROMATECT® 100 cover strips at horizontal board joint

See [page 60](#) and [61](#) for bottom and top track fixings; [pages 67 to 71](#) for details of wall head, wall base, wall junction and wall movement joints.

Horizontal sheeting with channel joint / Non loadbearing

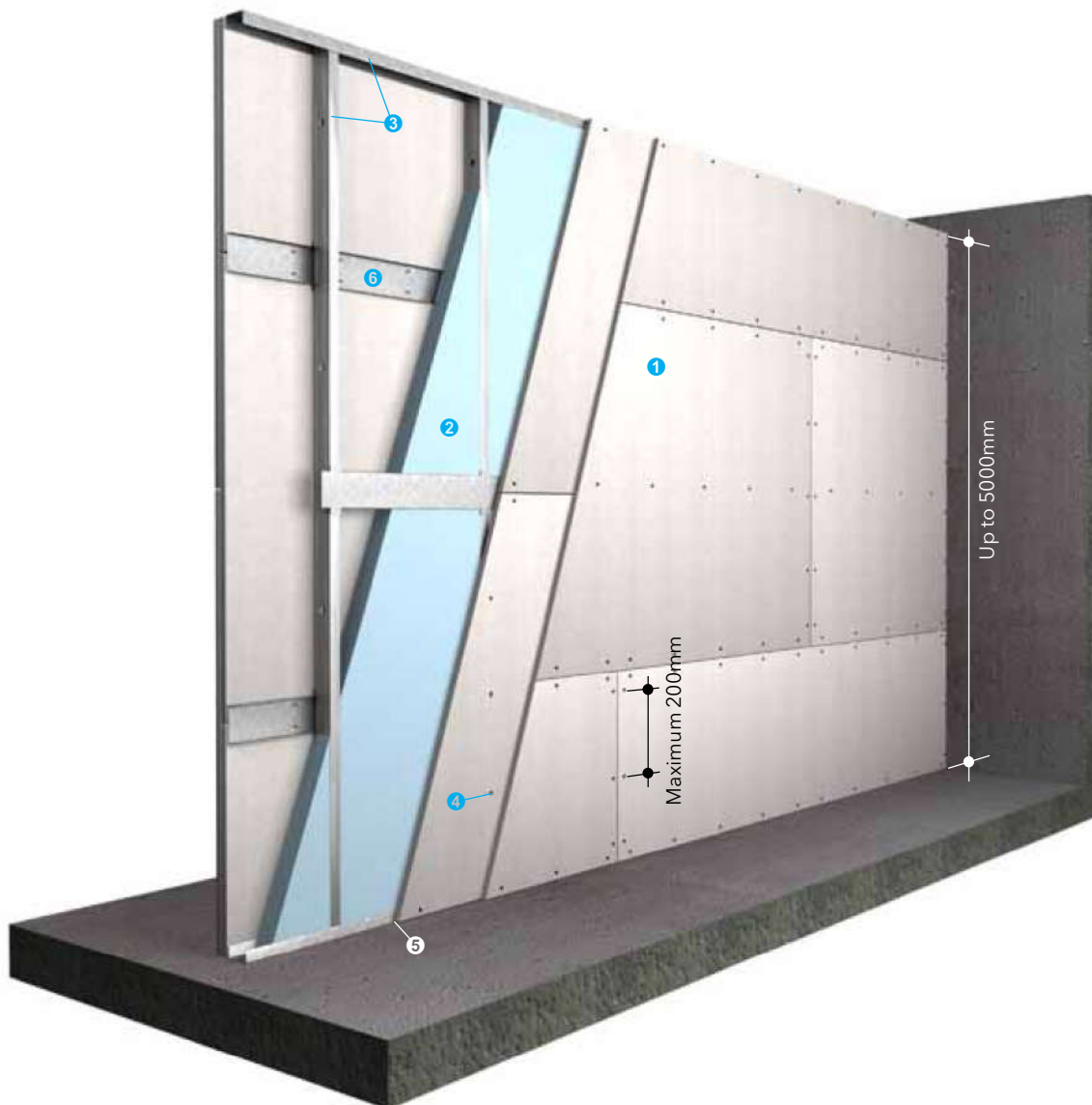

- ❶ Two layer of PROMATECT® 100 board 20mm thick on both sides of steel studs
- ❷ Cavity infill if required to improve acoustic or thermal insulation
- ❸ Galvanised steel studs, measurements in accordance with Studs Tables on [page 94](#) (allow appropriate expansion at top horizontal track)
- ❹ 32mm long self-tapping screws at maximum 300mm centres
50mm long self-tapping screws at maximum 200mm centres to fixed second layer to frame
40mm long stitching screws at maximum 200mm centres to fixed second layer to first layer
- ❺ Caulk all perimeter gaps with PROMASEAL®-A Acrylic Sealant to achieve the required fire resistance and/or acoustic performance
- ❻ Fixing channel 100mm x 10mm x 0.9mm thick

See [pages 60 and 61](#) for bottom and top track fixings; [pages 67 to 71](#) for details of wall head, wall base, wall junction and wall movement joints.

The following are standard Architectural Specifications for single steel stud partition systems using PROMATECT® 100. The designer must determine the suitability of the design to the application and requirements before undertaking or constructing any works relating to the specifications and where in doubt should obtain the advice of a suitably qualified engineer.

Fire attack from either side / non loadbearing

Up to 240 minute fire resistance, integrity and insulation in accordance with the criteria of AS 1530:Part 4: 2014⁽¹⁾. Lateral load of up to 0.25kPa.

Acoustic performance

The partition system shall have a Weighted Sound Reduction Index up to R_w 50.

Supporting structure

Care should be taken that any structural element that the partition system is supported from, e.g. steel stud or perimeter steel channel, has fire resistance equal to or greater than FRL of the partition.

Lining boards

One or two⁽²⁾ layer on either side of 15mm or 20mm⁽³⁾ thick PROMATECT® 100 PromaX® mineral boards as manufactured by Promat International (Asia Pacific) Ltd. All joints to be coincident with steel framing. Standard board dimension 1200mm x 2500mm x 20mm thick.

Fixing

Galvanised steel frame made of ceiling and floor tracks will be secured to the floor, ceiling and walls with 40mm long M6 masonry anchors at 500mm centres. Vertical steel studs are then friction fitted into the tracks at 600mm centres for boards to be installed with long edge vertically and at 625mm centres for boards to be installed with long edge horizontally. Adequate clearance for vertical expansion will be allowed at the ceiling/top track. No clearance is necessary at the bottom track. See table below for steel size and clearance at top track for given partition height.

Horizontal noggings, cut out of the steel track material will be friction fitted between the steel studs to coincide with horizontal joints between boards.

Studs table

Partitions lined with 20mm thick PROMATECT® 100 using studs at 600mm centres, 0.25kPa, minimum two rows of nogging at 1200mm centres. Contact Promat for stud tables for 60 and 240 minute walls.

Maximum partition height	Stud depth	Maximum stud thickness	Maximum partition thickness	Top track	Clearance at top track
4000mm	64mm	0.55mm	104mm	65 x 46 x 0.7mm	20mm

20mm thick PROMATECT® 100 boards will be screw-fixed to the frame with 35mm x No.8 self-tapping screws at maximum 300mm centres.

Tests & standards

Along with all material tests the complete system along with the framing is tested in accordance with the criteria of BS 476: Part 476: 1987 and/or AS 1530: Part 4: 2014⁽¹⁾. The partition system should meet the requirements specified in NCC Specification C1.8 or S6C1 for static, dynamic and indentation load tests as specified under Clauses 3.1, 3.2 and 3.4 or S6C3, S6C4 or S6C5

Jointing

- Plain butt joints between machined edges of boards. ⁽⁴⁾
- Joints filled in preparation for painting. ⁽⁵⁾
- Joints filled and taped in preparation for decoration. ⁽⁶⁾

Follow-on trades

Surface of boards to be prepared for painting/plastering/tiling⁽⁵⁾ in accordance with manufacturer's recommendations.

NOTES:

- (1), (2), (3), (4), (5), (6) delete as appropriate.
- All perimeter gaps caulked with PROMASEAL®-A Acrylic Sealant.



Fire resistance	FRL	-/120/120
	Standard	AS 1530: Part 4: 2005
	Approval	WFRA 45833
Acoustic	STC, R _w	See acoustic table below
	Standard	ISO 140: Part 3: 1996 ISO 717: Part 1: 1996
	Predicted assessment	Marshall Day 18th October 2006
Construction	Maximum height*	3000mm
	Maximum length	Unlimited
	Partition thickness	From 178mm
	Partition mass*	From 36kg/m ²

* Details for walls above 3000mm high are available on request

- ① One layer of PROMATECT® 100 board 20mm thick at both sides of steel studs
- ② Galvanised steel studs, measurements in accordance with Studs Table on page 98 (allow appropriate expansion at top horizontal track)
- ③ 45mm long No.8 self-tapping screws at maximum 300mm centres
- ④ 40mm long M6 masonry anchors at nominal 500mm centres
- ⑤ Caulk all perimeter gaps with PROMASEAL®-A Acrylic Sealant to achieve the required fire resistance and/or acoustic performance
- ⑥ A minimum 10mm air space to be left between the frames to ensure best acoustic performance

Acoustic Table

Stud depth	64mm	76mm	92mm	150mm
Cavity infill	# STC / R _w (C _{tr})			
a) Nil	40/44dB (-6)	41/45dB (-6)	43/46dB (-6)	47/49dB (-7)
b) Glasswool partition batts 50mm x 32kg/m ³	58/59dB (-8)	58/60dB (-7)	58/60dB (-6)	58/61dB (-5)
c) Glasswool partition batts 75mm x 32kg/m ³	59/59dB (-7)	59/60dB (-7)	59/61dB (-7)	59/62dB (-6)
d) ASB3 / TSB3 Polyester batts 60mm x 8kg/m ³	56/57dB (-6)	56/58dB (-6)	56/59dB (-6)	56/59dB (-5)
e) Soundscreen™ R1.6 Batts 60mm	57/58dB (-7)	57/59dB (-7)	57/59dB (-6)	57/60dB (-5)

NOTE: Above values are predicted figures. # Margin of error is generally within ±3dB

Horizontal sheeting with strip joint / Non loadbearing

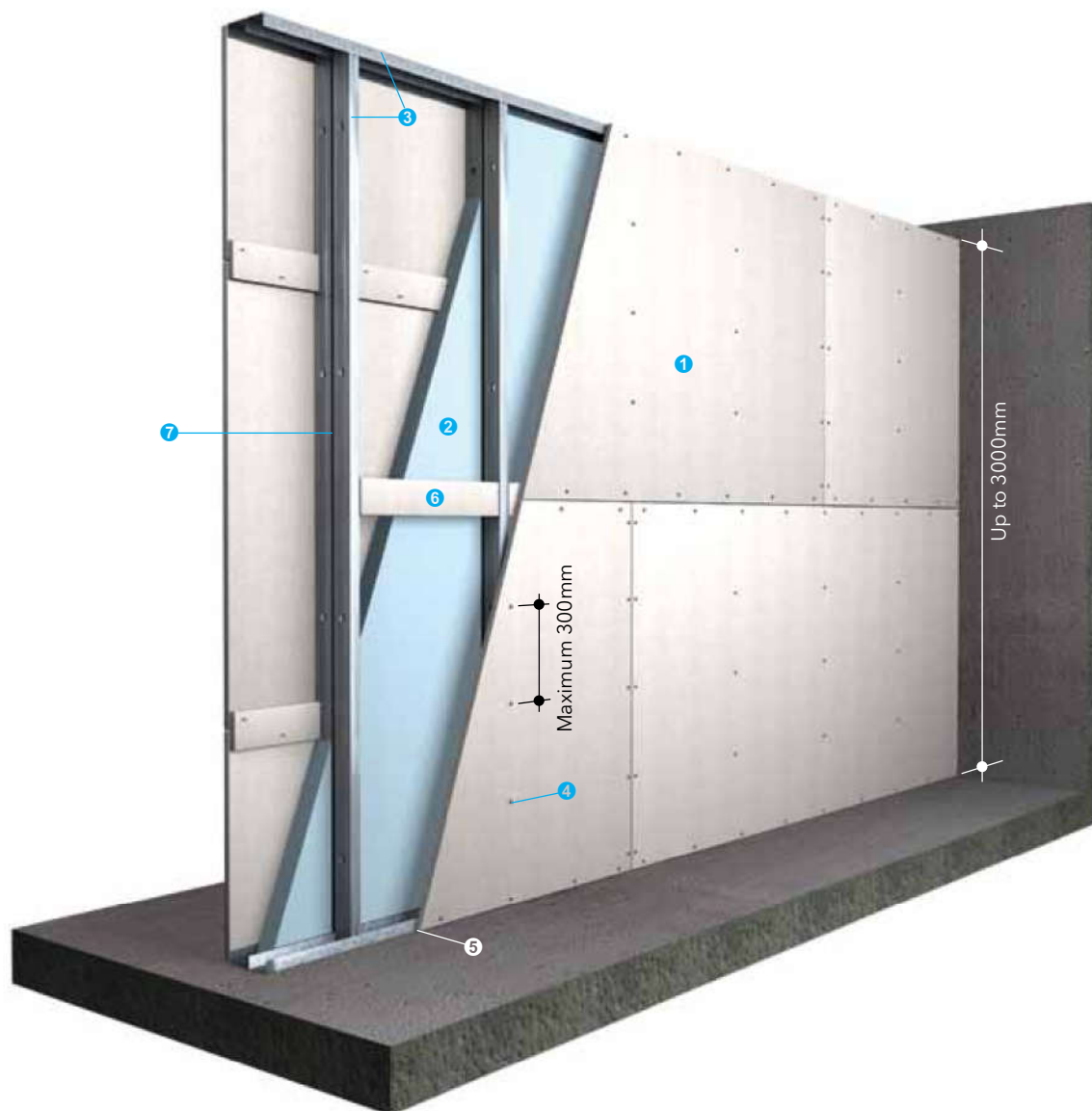

- ❶ One layer of PROMATECT® 100 board 20mm thick at both sides of steel studs
- ❷ Cavity infill if required to improve acoustic or thermal insulation
- ❸ Galvanised steel studs, measurements in accordance with Studs Table on page 98 (allow appropriate expansion at top horizontal track)
- ❹ 45mm long No.8 self-tapping screws at maximum 300mm centres
- ❺ Caulk all perimeter gaps with PROMASEAL®-A Acrylic Sealant to achieve the required fire resistance and/or acoustic performance
- ❻ 20mm thick PROMATECT® 100 cover strips
- ❼ A minimum 10mm air space to be left between the frames to ensure best acoustic performance

See pages 60 and 61 for bottom and top track fixings; pages 67 to 71 for details of wall head, wall base, wall junction and wall movement joints.

The following are standard Architectural Specifications for double steel stud partition systems using PROMATECT® 100. The designer must determine the suitability of the design to the application and requirements before undertaking or constructing any works relating to the specifications and where in doubt should obtain the advice of a suitably qualified engineer.

Fire attack from either side / non loadbearing

Up to 120 minute fire resistance, integrity and insulation in accordance with the criteria of AS1530: Part 4: 2014⁽¹⁾.

Acoustic performance

The partition system shall have a Weighted Sound Reduction Index up to R_w 60.

Supporting structure

Care should be taken that any structural element that the partition system is supported from, e.g. steel stud or perimeter steel channel, has a fire resistance equal to or greater than 120 minutes.

Lining boards

Single layer each side 20mm thick PROMATECT® PromaX® mineral boards as manufactured by Promat International (Asia Pacific) Ltd. All joints to be coincident with steel framing. Standard board dimension 1200mm x 2500mm x 20mm thick.

Fixing

2 rows of galvanised steel framing made of ceiling and floor tracks will be secured to the floor, ceiling and walls with 40mm long M6 masonry anchors at 500mm centres. An air gap of 10mm minimum will be provided between the two rows of the galvanised steel frame. Vertical steel studs are then friction fitted into each of the two rows tracks at 600mm centres for boards to be installed vertically and at 625mm centres for boards to be installed horizontally. Adequate clearance for vertical expansion will be allowed at the ceiling/top track. No clearance is necessary at the bottom track. See table below for steel size and clearance at top track for given partition height.

Horizontal noggings, cut out of the steel track material will be friction fitted between the steel studs.

Tests & standards

Along with all material tests the complete system along with the framing is tested in accordance with the criteria of AS 1530: Part 4: 2014⁽¹⁾.

Jointing

Plain butt joints between machined edges of boards. ⁽²⁾

Joints filled in preparation for painting. ⁽³⁾

Joints filled and taped in preparation for decoration. ⁽⁴⁾

Follow-on trades

Surface of boards to be prepared for painting/plastering/tiling⁽⁵⁾ in accordance with manufacturer's recommendations.

NOTES:

- (1), (2), (3), (4), (5) delete as appropriate.
- All perimeter gaps caulked with PROMASEAL®-A Acrylic Sealant.



Fire resistance	FRL	-/90/90 90/90/90
	Standard	AS 1530: Part 4: 2014
	Approval	BRANZ FR6112
Acoustic	# STC # R _w	35dB 39dB
	Standard	ISO 140: Part 3: 1996 ISO 717: Part 1: 1996
	Predicted assessment	Marshall Day 18th October 2006
Construction	Maximum height	4000mm
	Maximum length	Unlimited
	Partition thickness	From 130mm
	Partition mass*	From 37kg/m ²

Margin of error is generally within ±3dB

- ① One layer of PROMATECT® 100 board 20mm thick
- ② Timber studs 90mm deep x 45mm wide at nominal 600mm or 625mm centres
- ③ 75mm long No.8 woodscrews or 75mm long nails at 200mm nominal centres
- ④ M12 expanding anchors at 500mm maximum centres
- ⑤ Caulk all perimeter gaps with PROMASEAL®-A Acrylic Sealant to achieve the required fire resistance and/or acoustic performance

For 60/60/60 use same framing as above and substitute 15mm PROMATECT® 100 boards on each face

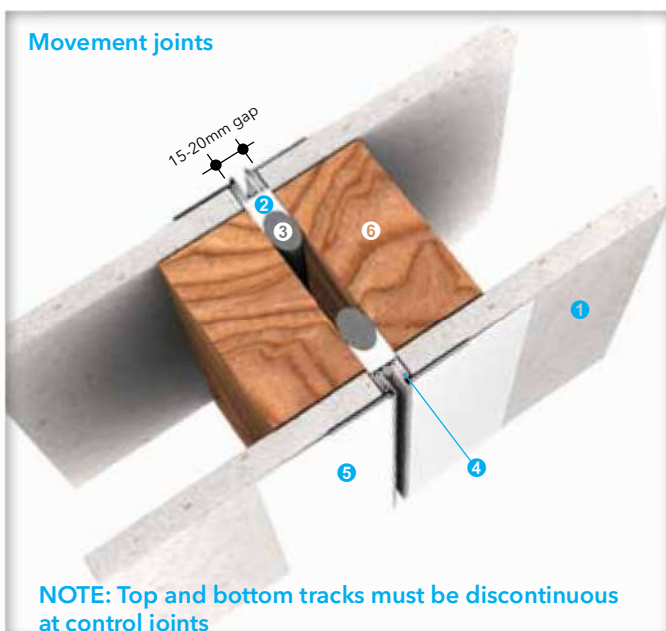

- ① PROMATECT® 100 board
- ② PROMASEAL®-A Acrylic Sealant
- ③ Backing rod
- ④ RONDO P35 or equivalent control joint profile
- ⑤ Finish surface as per external angles
- ⑥ Timber studs 90mm x 45mm at 625mm centres

NOTE: Top and bottom tracks must be discontinuous at control joints

Vertical sheeting / Non loadbearing

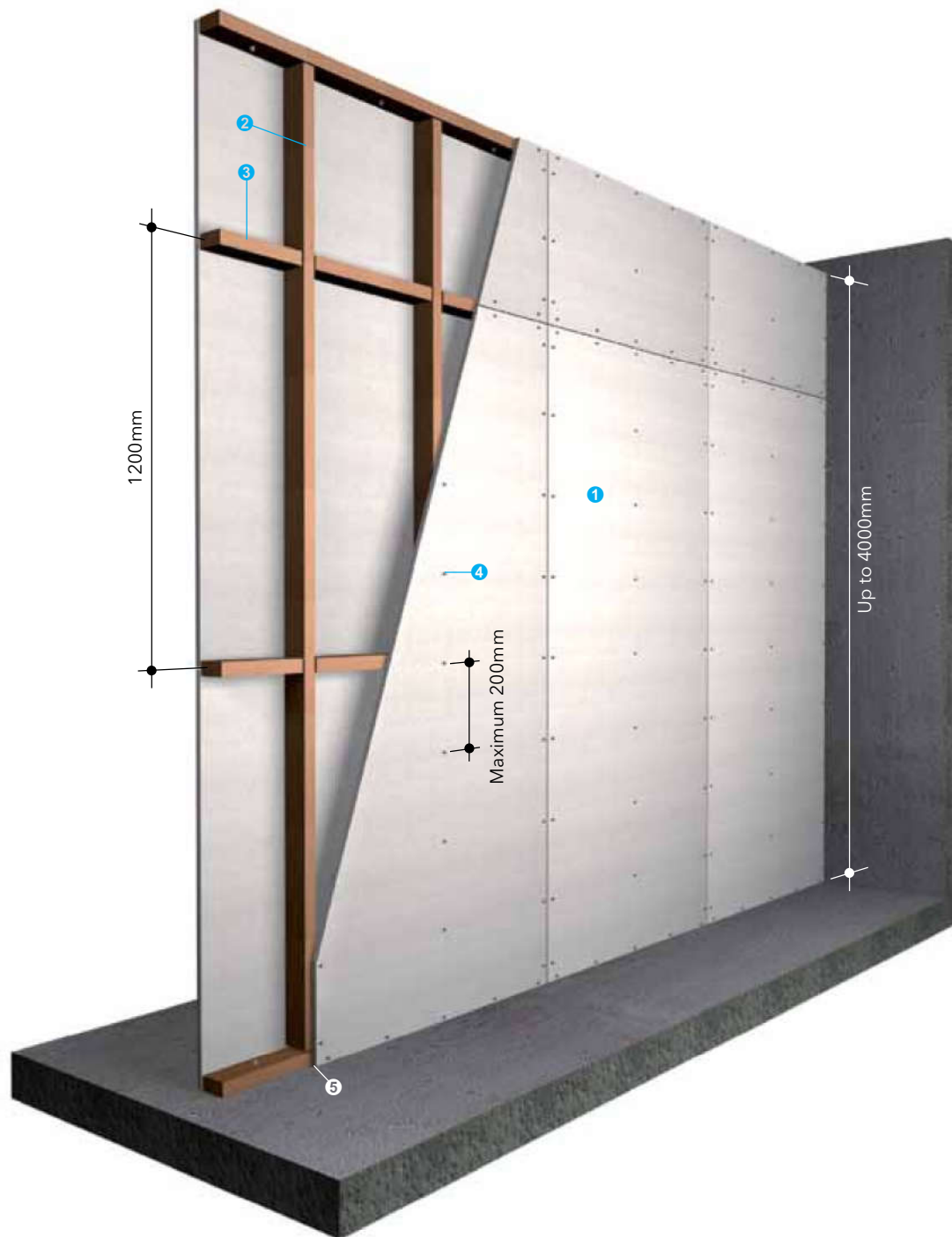

- ❶ One layer of PROMATECT® 100 board 20mm thick
- ❷ Vertical studs at 600mm centres
- ❸ Horizontal noggings at 1250mm centres
- ❹ 75mm x No.8 woodscrews at 200mm nominal centres or 75mm long nails at 200mm centres
- ❺ Caulk all perimeter gaps with PROMASEAL®-A Acrylic Sealant to achieve the required fire resistance and/or acoustic performance

See page 63 for fixings of cross noggings and floor plate; page 99 for detail of wall movement joints.

Horizontal sheeting with nogging joint / loadbearing

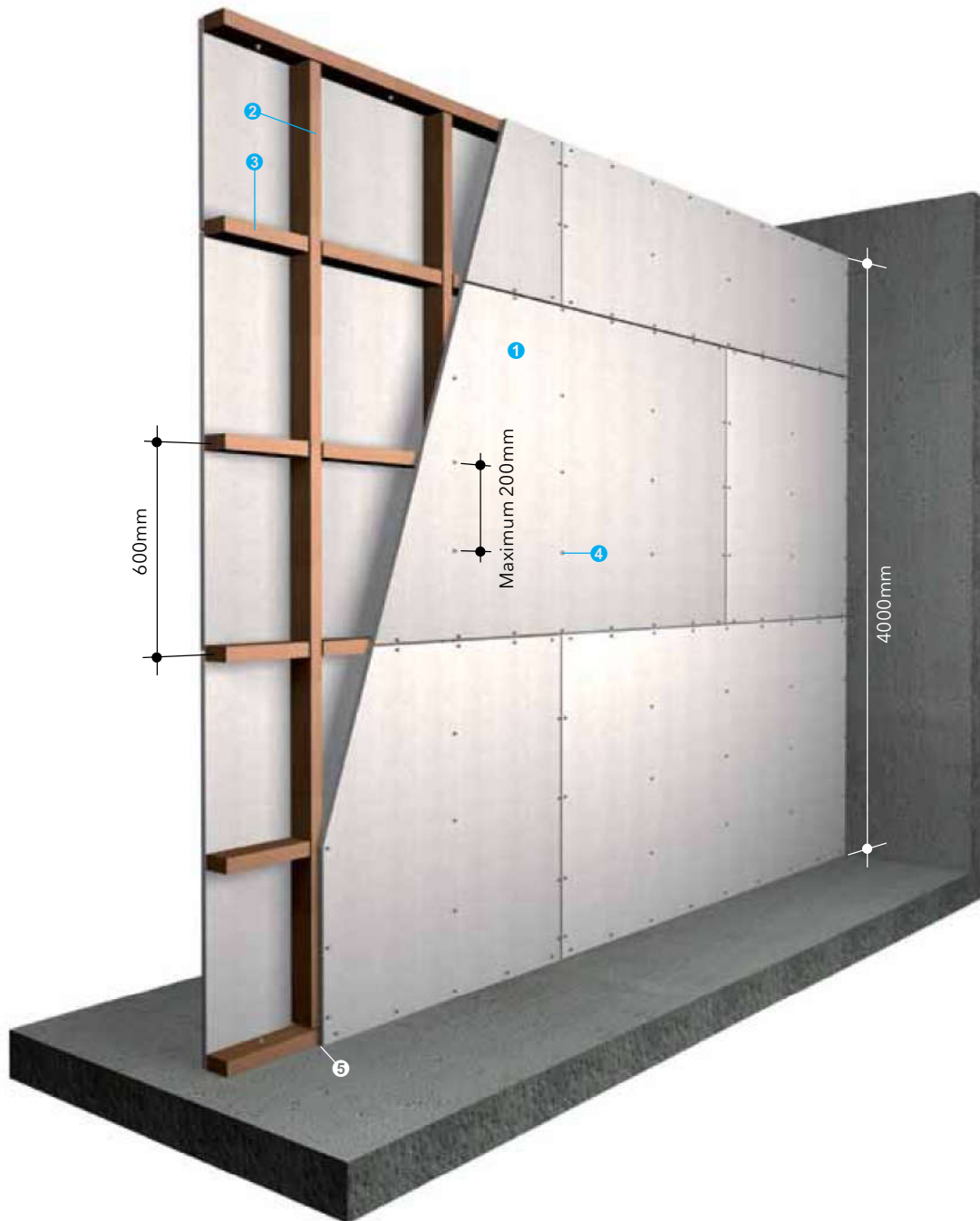

- ① One layer of PROMATECT® 100 board 20mm thick
- ② Vertical studs at 625mm centres
- ③ Horizontal nogging at 600mm centres
- ④ 75mm long No.8 woodscrews at 200mm nominal centres
- ⑤ Caulk all perimeter gaps with PROMASEAL®-A Acrylic Sealant to achieve the required fire resistance and/or acoustic performance

See page 63 for fixings of cross noggings and floor plate; page 99 for detail of wall movement joints.

The following are standard Architectural Specifications for timber stud partition systems using PROMATECT® 100. The designer must determine the suitability of the design to the application and requirements before undertaking or constructing any works relating to the specifications and where in doubt should obtain the advice of a suitably qualified engineer.

Fire attack from either side / non loadbearing & loadbearing

Up to 120 minute fire resistance, integrity and insulation in accordance with the criteria of AS 1530:Part 4: 2014⁽¹⁾.

Acoustic performance

The partition system shall have a Weighted Sound Reduction Index up to R_w 39.

Supporting structure

Care should be taken that any structural element that the partition system is supported from, e.g. steel stud or perimeter steel channel, has a fire resistance equal to or greater than 120 minutes.

Lining boards

Single layer each side 20mm thick PROMATECT® 100 PromaX® mineral boards as manufactured by Promat International (Asia Pacific) Ltd. All joints to be coincident with steel framing. Standard board dimension 1200mm x 2500mm x 20mm thick.

Fixing

Softwood timber, 90mm deep x 45mm wide will be fixed to the perimeter of the opening where the partition system is to be installed using M12 expanding anchors at 500mm maximum centres.

Where the boards are to be installed with their long edges vertical, the studs are located at 625mm maximum centres with cross noggings at 1200mm centres. Where the boards are to be installed with their long edges horizontal, the studs are located at 625mm centres with cross noggings at 600mm centres.

The PROMATECT® 100 boards are fixed to the framework using 75mm long No.8 woodscrews at maximum 200mm centres or 75mm long nails at 200mm centres, a minimum of 12mm from the board edge.

Tests & standards

Along with all material tests the complete system along with the framing is tested in accordance with the criteria of BS 476: Part 22: 1987 and AS 1530: Part 4: 2014⁽¹⁾.

Jointing

Plain butt joints between machined edges of boards. ⁽²⁾

Joints filled in preparation for painting. ⁽³⁾

Joints filled and taped in preparation for decoration. ⁽⁴⁾

Follow-on trades

Surface of boards to be prepared for painting/plastering/tiling⁽⁵⁾ in accordance with manufacturer's recommendations.

NOTES:

- (1), (2), (3), (4), (5) delete as appropriate.
- All perimeter gaps caulked with PROMASEAL®-A Acrylic Sealant.

Fire attack from both sides / Non loadbearing



Fire resistance	FRL	-/120/120
	Standard	BS 476: Part 22: 1987 AS 1530: Part 4: 2005
	Approval	BRANZ FAR 2837 and FAR 3309
Acoustic	# STC # R _w	36dB 36dB
	Standard	ISO 140: Part 3: 1996 ISO 717: Part 1: 1996
	Predicted assessment	Marshall Day 18th October 2006
Construction	Maximum height*	4300mm
	Maximum length	Unlimited
	Partition thickness	Nominal 40mm
	Partition mass*	34kg/m ²

Margin of error is generally within ±3dB

- ① Two layers of PROMATECT® 100 board, 20mm thick each stagger the joints by at least 300mm
- ② Galvanised steel perimeter angle 50mm x 50mm x 1mm thick
- ③ 40mm long M6 masonry anchors at nominal 500mm centres
- ④ 32mm long No.8 self-tapping screws at nominal 300mm centres for first layer and 50mm long No.8 self-tapping screws at nominal 200mm centres for second layer
- ⑤ 40mm long No.10 laminating stitching screws at 200mm centres

Once 1st layer of board is screwed to the perimeter angles, all subsequent layers are:

- a) fixed to the perimeter angle, and
- b) stitched to the proceeding layers of boards

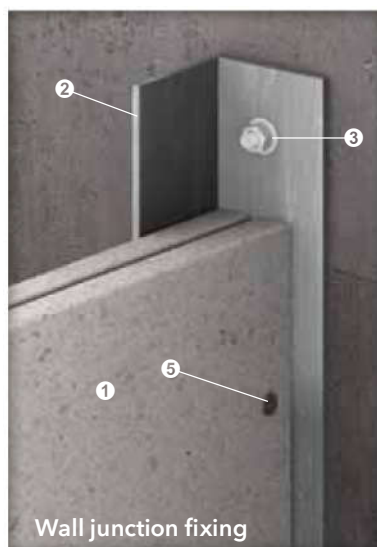
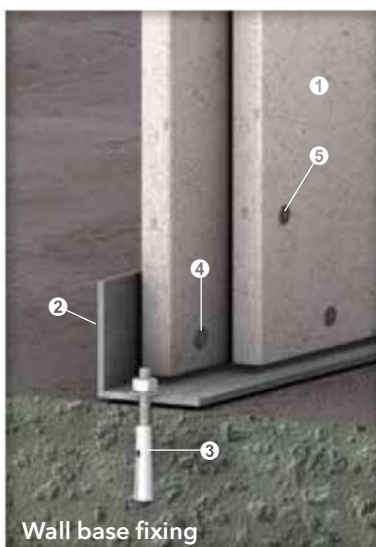

- ① PROMATECT® 100 board
- ② Galvanised steel perimeter angle 50mm x 50mm x 1mm thick
- ③ 40mm long M6 masonry anchors at nominal 500mm centres
- ④ 32mm long No.8 self-tapping screws at nominal 300mm centres for first layer and 50mm long No.8 self-tapping screws at nominal 200mm centres for second layer
- ⑤ 40mm long No.10 laminating stitching screws at 200mm centres

Once first layer of board is screwed to the perimeter angles, all subsequent layers are:

- a) fixed to the perimeter angle, and
- b) stitched to the proceeding layers of boards

Two layer / Non loadbearing

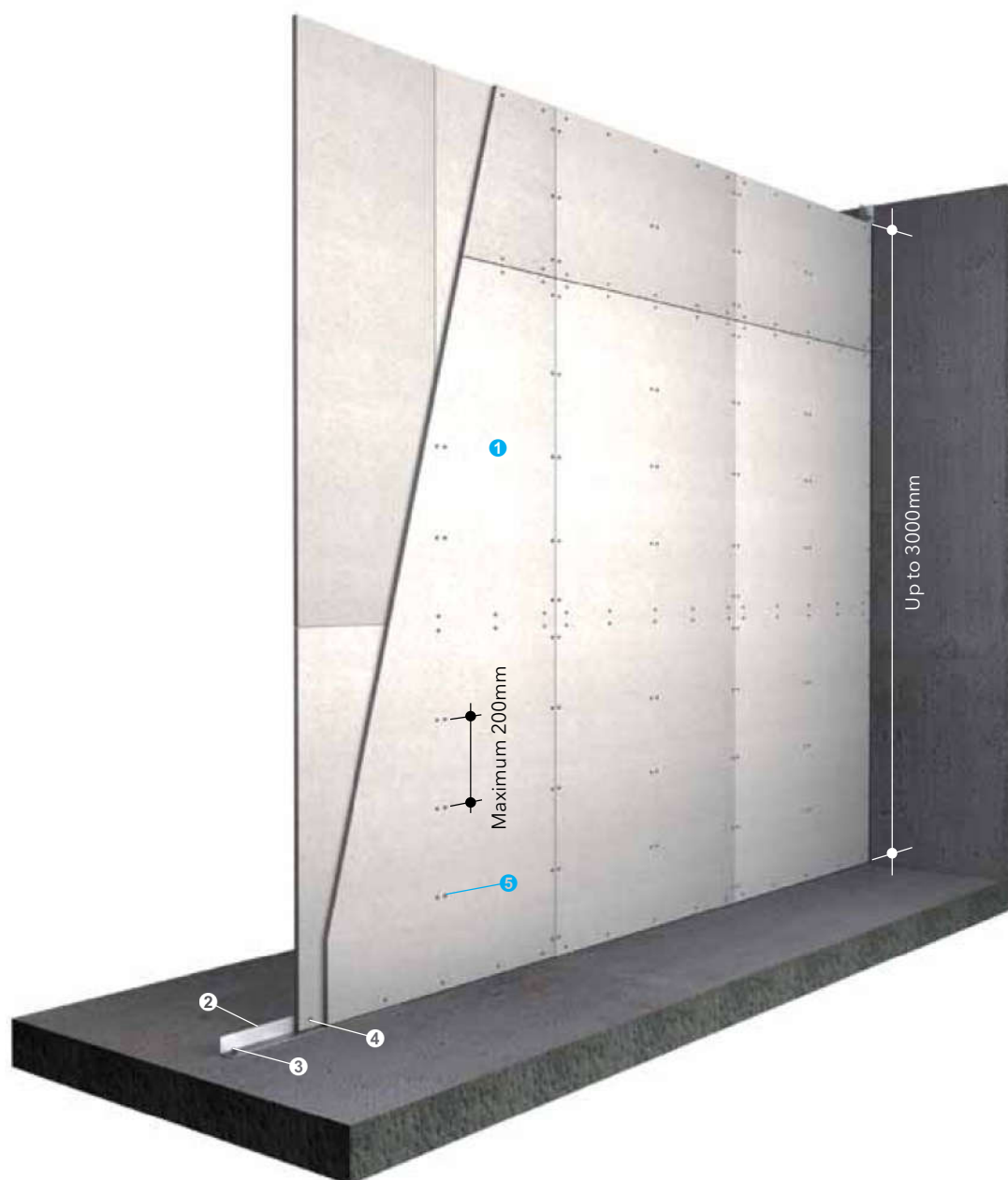

- ❶ Two layers of PROMATECT® 100 board, 20mm thick each stagger the joints by at least 300mm
- ❷ Galvanised steel perimeter angle 50mm x 50mm x 1mm thick
- ❸ 40mm long M6 masonry anchors at nominal 500mm centres
- ❹ 32mm long No.8 self-tapping screws at nominal 300mm centres for first layer and 50mm long No.8 self-tapping screws at nominal 200mm centres for second layer
- ❺ 40mm long No.10 laminating stitching screws at 200mm centres

Once first layer of board is screwed to the perimeter angles, all subsequent layers are:

- a) fixed to the perimeter angle, and
- b) stitched to the proceeding layers of boards

See page 103 for wall connection details

The following are standard Architectural Specifications for solid internal partition systems using PROMATECT® 100. The designer must determine the suitability of the design to the application and requirements before undertaking or constructing any works relating to the specifications and where in doubt should obtain the advice of a suitably qualified engineer.

Fire attack from either side / non loadbearing

Up to 120 minute fire resistance, integrity and insulation in accordance with the criteria of BS 476: Part 22: 1987 and AS 1530: Part 4: 2005⁽¹⁾.

Acoustic performance

The partition system shall have a Weighted Sound Reduction Index up to R_w 36.

Supporting structure

Care should be taken that any structural element by which the partition system is supported, e.g. steel stud or perimeter steel channel, has a fire resistance equal to or greater than 120 minutes.

Lining boards

Two layers of 20mm thick PROMATECT® 100 PromaX® mineral boards as manufactured by Promat International (Asia Pacific) Ltd. Stagger joints by at least 300mm. Standard board dimension 1200mm x 2500mm x 20mm thick.

Fixing

Galvanised steel frame made of perimeter steel angle 50mm x 50mm x 1mm thick will be fastened to the wall/floor/ceiling with 40mm long M6 masonry anchors at nominal 500mm centres.

First layer of 20mm thick PROMATECT® 100 boards will be fixed to the perimeter angle using 32mm long No.8 self-drilling or self-tapping screws at 300mm centres. Second layer 20mm, fixed to the first layer using 40mm long No.10 laminating stitching screws at 300mm centres down the centre of each panel at each board joint. Use 50mm x No.8 self-tapping screws at 200mm centres to fix second layer to the perimeter angle.

Tests & standards

The complete system along with material and framing is tested in accordance with the criteria of BS 476: Part 22: 1987 and AS 1530: Part 4: 2005⁽¹⁾.

Jointing

Plain butt joints between machined edges of boards. ⁽²⁾

Joints filled in preparation for painting. ⁽³⁾

Joints filled and taped in preparation for decoration. ⁽⁴⁾

Follow-on trades

Surface of boards to be prepared for painting/plastering/tiling⁽⁵⁾ in accordance with manufacturer's recommendations.

NOTES:

- ^{(1), (2), (3), (4), (5)} delete as appropriate.
- All perimeter gaps caulked with PROMASEAL®-A Acrylic Sealant.

Promat Australia Pty Ltd

Head office

1 Scotland Road
Mile End South, SA 5031
T 1800 PROMAT (776 628)
F +61 (8) 8352 1014
E PAPT.Mail@etexgroup.com

New South Wales office

Unit 1, 175 Briens Road
Northmead, NSW 2152
T 1800 PROMAT (776 628)
F +61 (2) 9630 0258
E PAPT.Mail@etexgroup.com

Victoria office

Suite 205, 198 Harbour Esplanade
Docklands, VIC 3008
T 1800 PROMAT (776 628)
F 1800 334 598
E PAPT.Mail@etexgroup.com

Queensland office

433 Logan Road
Stones Corner, QLD 4120
T 1800 011 376
F 1800 334 598
E PAPT.Mail@etexgroup.com

- The technical data provided in this publication is based on mean values prevalent at time of publication and is thus subject to fluctuation. It should not be regarded as a guarantee to system performance.
- All data contained herein conforms to and frequently surpasses generally accepted fire protection standards recognised by most professional fire science practitioners and regulatory authorities worldwide. The same general principle is equally applicable to all Promat products and systems. Promat has access to a considerable body of test authentication data and this can be provided on a complimentary basis upon request. It should be noted however that this publication replaces all previous editions in its entirety. Any form of reproduction by any means – manual, electronic, digital or otherwise – is strictly prohibited and subject to prior approval in writing from Promat. All rights related or connected to the Promat logo, Promat registered trademarks, featured illustrations, written information and technical reports in this publication are the sole, exclusive and copyright property of Promat and its legal partner companies.

www.promat.com

Your local Promat supplier

Etex is a Belgian industrial group that specialises and markets high quality building materials and systems. Founded since 1905 and headquartered in Brussels, Belgium, Etex currently operates in 123 factories and 116 subsidiaries across 44 countries, employs more than 18,000 people and is one of the largest fibre cement producers in the world.

Through its subsidiaries, the group offers an extensive range of products: small and large roofing materials, cladding and building boards, passive fire protection systems and ceramic tiles.

Etex aims to be a professional, solid partner for all kinds of building projects.

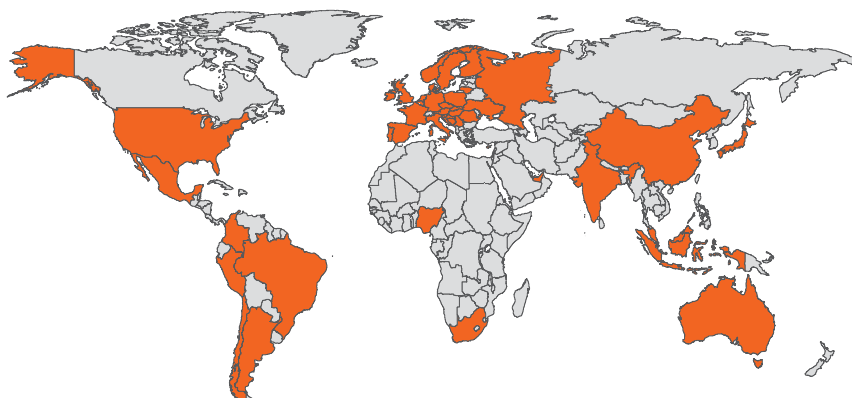

Partitions









Ceilings and floors



Ceiling type	Fire resistance performance	Mineral wool thickness x density	Total ceiling thickness	Test/Approval no.	Page no.
 <p>PROMATECT® 100 self-supporting membrane ceiling</p>	-/120/120	Not required	From 150mm	BRE CC 232157A to the requirements of AS 1530: Part 4: 2005	118
 <p>PROMATECT® 100 self-supporting membrane ceiling</p>	-/120/120	Not required	From 150mm	BRE CC 232157A to the requirements of AS 1530: Part 4: 2005	119
 <p>PROMATECT® 100 self-supporting membrane ceiling</p>	-/120/120	Not required	From 105mm	BRANZ FAR 2885 to the requirements of AS 1530: Part 4: 2005	120
 <p>PROMATECT® 100 self-supporting membrane ceiling</p>	-/240/240	Not required	From 156mm	BRANZ FAR 4283 to the requirements of AS 1530: Part 4: 2005	120
 <p>PROMATECT® 100 timber floor protection</p>	60/60/60	Not required	267mm	BRANZ FAR 2886 to the requirements of AS 1530: Part 4: 2005	124
 <p>PROMATECT® 100 timber floor protection</p>	90/90/90	Not required	267mm	LPC TE90019 to the requirements of BS 476: Part 21: 1987	125

Ceiling type	Fire resistance performance	Mineral wool thickness x density	Total ceiling thickness	Test/Approval no.	Page no.
 <p>PROMATECT® 100 timber floor protection</p>	90/90/90	Not required	287mm	BRANZ FAR 2886 to the requirements of AS 1530: Part 4: 2005	126
 <p>PROMATECT® 100 timber floor protection</p>	120/120/120	Not required	267mm	BRANZ FAR 2924 to the requirements of AS 1530: Part 4: 2005	127
 <p>PROMATECT® 100 mezzanine floor</p>	60/60/60	Not required	253mm	BRE CC 234724 to the requirements of AS 1530: Part 4: 2005	129
 <p>PROMATECT® 100 mezzanine floor</p>	120/120/120	Not required	278mm	BRE CC 234729 to the requirements of AS 1530: Part 4: 2005	130

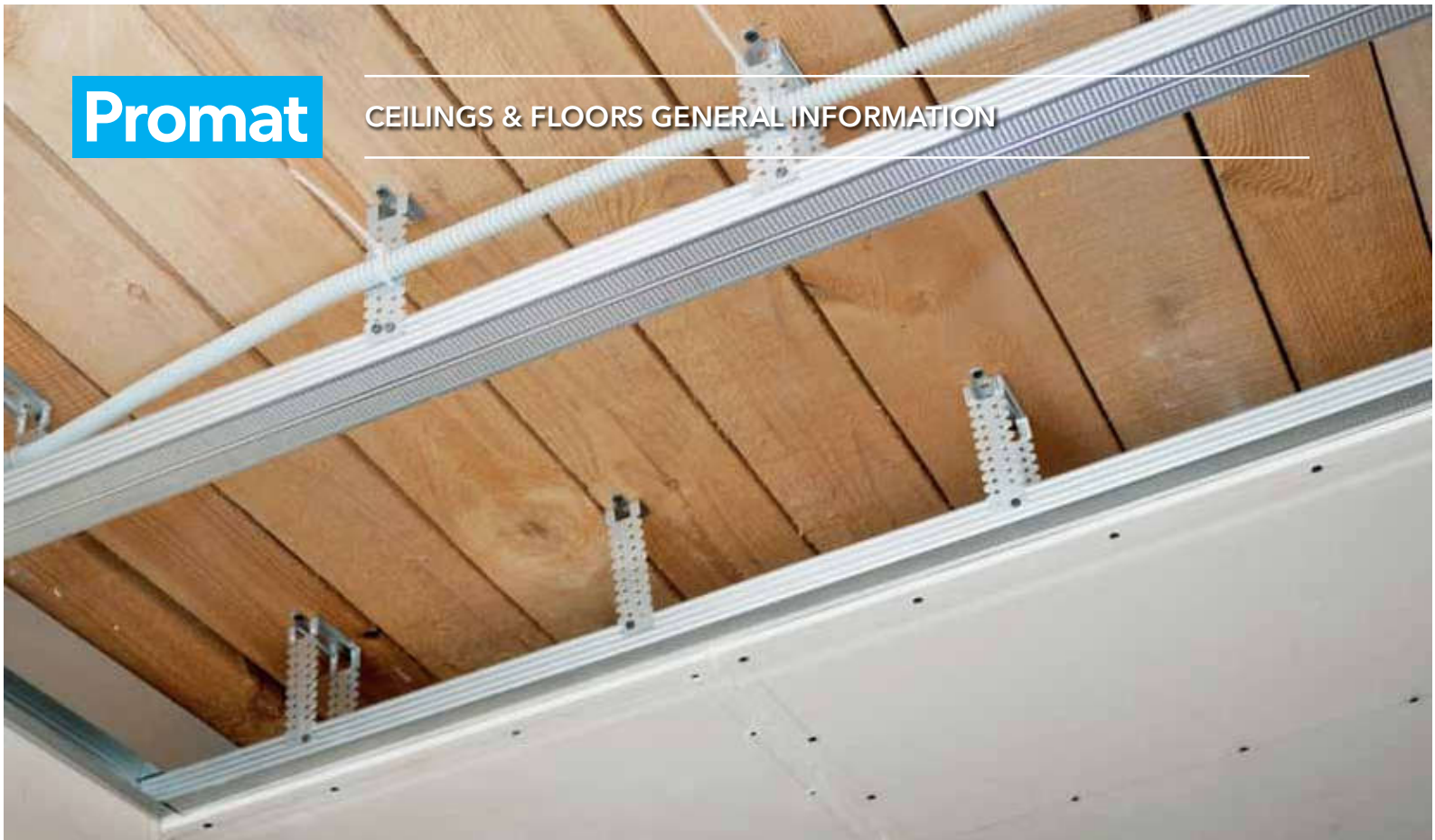

Introduction

Promat carries a wide range of fire rated ceiling and floor systems with fire resistance of up to 240 minutes. Generally, Promat's ceiling and floor systems provide horizontal fire barriers to prevent vertical spread of fire.

Promat's ceiling and floor systems have been extensively tested and assessed to provide resistance to fire from above, below or above and below. They satisfy the integrity and insulation criteria of BS 476: Parts 20, 21, 22 and 23: 1987 and/or AS 1530 Part 4: 2005. The flooring systems not only meet the integrity and insulation criteria but also meet the loadbearing capacity (structural adequacy) criteria of the British and Australian national standards.

The system design depends on performance requirements but in overall terms, Promat's ceiling and floor systems can be divided into the following categories.

Self-supporting membrane ceilings

These are normally non loadbearing and, depending on the type of construction, are used to provide protection from fire attack from below and/or above. Ceiling panels are fixed into a steel or timber framing system spanning and supported between two walls.

Self-supporting membrane ceilings should normally be tested or assessed in accordance with BS 476: Part 22: 1987 and/or AS 1530: Part 4: 2005 to satisfy the failure criteria of integrity and insulation.

These ceiling systems allow for the protection to or from services contained within the ceiling void. They will also provide protection to steel beams that are required to meet the criteria of BS 476: Parts 21 and 23: 1987 where exposure to fire is from below.

Suspended membrane Ceilings

These are normally non loadbearing and are used to provide protection from fire attack from below. The ceilings generally incorporate steel grid systems suspended from a structure.

Suspended membrane ceilings should normally be tested or assessed in accordance with BS 476: Part 22: 1987 and/or AS 1530: Part 4: 2005 to satisfy the failure criteria of integrity and insulation.

These ceiling systems allow for the protection to or from services contained within the ceiling void. They also provide protection to steel beams that are required to meet the criteria of BS 476: Parts 21 and 23: 1987 where exposure to fire is from below.

Loadbearing floor systems

The flooring can be of timber or chipboard floor boards supported by either timber joists or steel joists system. Promat boards can be directly fixed onto these joists or fixed to a suspended exposed or concealed metal grid system.

This type of ceiling should normally be tested or assessed in accordance with BS 476: Part 21: 1987 and/or AS 1530: Part 4: 2005 and are required to satisfy the three failure criteria of loadbearing capacity (structural adequacy), integrity and insulation.

Suspended ceiling protection to steel beams

This type of ceiling is used mainly for protection of steel beams supporting a loadbearing concrete floor slab and should be tested or assessed to BS 476: Part 23: 1987 and AS 1530: Part 4: 2005. Promat boards are fixed to a metal exposed or concealed grid system suspended from the structure above.

Advantages

Promat's ceiling and floor systems require less material to achieve similar fire resistant levels when compared to the industry average. This can lead to more simplified construction methods than the standard equivalent. Use of Promat boards therefore helps to increase productivity and reduce overall installation costs.

Promat's ceiling and floor systems have been developed by Promat International to satisfy standard requirements for internal applications. Benefits include:

Time & cost effectiveness

Simple construction methods reduce installation cost and time compared to traditional systems.

Lightweight

Lighter loads on structures compared to industry average systems for equivalent fire rating.

Thermal resistance

Excellent thermal resistance performance.

Design flexibility

Lighter weight allows increased ceiling span, reduced support structure sizes and/or reduced system thickness.

Acoustic performance

Tested and assessed to ISO140-3 1995 and ISO717-1 1996 to meet the needs of the industry. Please refer to the PARTITIONS section for more details.

Board fixing

Longitudinal board joints must coincide with framing members. If the boards are in one layer, the transverse joints must be backed with fillet strips made of Promat boards or timber noggings for traditional timber joist construction. For boards laminated in two layers, the joints must be staggered by at least 600mm.

Promat boards may be fixed to the steel members using No.8 bugle head self-drilling and self-tapping screws. No.8 woodscrews shall be used to fix boards to a timber frame. For boards laminated in two layers, the outer layer boards may be stitched to the preceding layer with No. 10 laminating screws.

Minimum edge distance to fasteners and the maximum spacing between screws must be maintained. Please refer to system details for screw spacing requirements.

General design considerations

Following are some of the factors to consider when determining correct specifications that ensure a ceiling or floor system provides the required design performance, under both fire and ambient conditions. Comprehensive advice is available from local Promat offices.

Supporting structure design

The design of the framing system should be adequate for the design loads of the ceiling and floor. Promat systems are designed for timber or steel framing as described in the system specification.

Timber framing systems used in loadbearing floor applications must be designed in accordance with BS 5268: 2006, AS 1720: Part 1: 2010 and/or AS 1684: 1999. The width, depth and spacing of joists must be carefully specified to ensure that the timber floor serves its intended fire performance.

For steel framed ceiling systems, it is critical to precisely follow the dimensions of the steel sections, the grid spacing, the suspension members (if any) and the fastening methods employed. Framing members could change depending on factors such as ceiling span, movement and deflection, and local regulations.

Larger or more frequent frame sections can often improve the fire and structural performance. The framing for the ceiling systems must be securely fixed back to a substrate that has an equal or greater fire performance than the ceiling. All fixings must be non-combustible and must be similar to those listed in the approval documents.

Non loadbearing ceilings

Promat non loadbearing ceiling systems can be generally divided into steel frame suspended ceiling and self-supporting membrane ceilings. The steel framing as noted in the system specification is appropriate for the given span. Larger dimension of steel sections or more frequent spacing will be required for a ceiling span larger than specified.

At wall connections, mechanical joints are required and these joints must be carefully designed so that they accommodate the required expansion of steel at elevated temperature.

Non loadbearing ceilings in this handbook are not trafficable. Trafficable ceilings for maintenance purposes can be designed and installed. Please consult Promat for complete information.

Loadbearing ceilings

Two types of Promat loadbearing floor systems are available. One is comprised of timber joists while the other is of steel joists. Flooring material, timber type, thickness and jointing are all critical. Timber framing, of solid timber only, must be designed in accordance with BS 5268: 2006, AS 1720.1: 2010 and/or AS 1684: 1999 whereas for steel framing, members must be designed in accordance with BS 5950: 2000 and/or AS 4600: 2005.

Acoustics

Promat ceiling and floor systems also meet specific acoustic requirements. These include ratings for sound transmission, sound impact and sound absorption. Please refer to [pages 64 to 66](#) for further information.

Movement joint

Movement stress from dimensional changes due to varying temperature or moisture conditions can cause cracking and other symptoms of distress in ceiling linings.

Other external forces such as impact or vibration can directly affect structural movement of ceilings. This movement can be controlled through a variety of design techniques such as introducing perimeter relief and slip connections to reduce the transfer of stress from the structure to other building sub elements and/or through the use of expansion joints, control joints and construction joints.

Expansion joints are needed when a ceiling abuts a rigid mass. Where ceiling dimensions exceed 10m in either direction, a control joint should be used. Control joints should also be located to intersect column penetrations, light fixtures and air diffusers. It is however, the introduction of a control joint into a fire resistant system when an opening for flame and temperature transmission is created. This and similar openings have to be properly treated with approved fire stopping materials from Promat.

Caulking & service penetrations

To maintain fire performance and, where applicable, acoustic performance of ceiling systems, perimeter and other gaps must be appropriately filled with suitable caulking material. PROMASEAL®-A Acrylic Sealant or other tested fire and acoustic rated material of equivalent or better performance must be used.

Care needs to be taken in detailing a suitable fire stopping system around any penetration of the ceiling by services to ensure:

- a) the fire stopping material remains in situ,
- b) fire and smoke do not penetrate the floor cavity,

c) and a premature collapse of the joists and/or penetration of fire and smoke through the time flooring does not occur.

Allowance should be made for thermal movement of the services in both ambient and fire conditions to ensure unacceptable loads are not applied to the ceiling assembly. Some examples of service penetrations include penetrations by electrical cables, conduits or wires, plastic and metal pipes, air conditioning and ventilation ductwork. Further guidance on the sealing of service penetrations can be obtained from the Promat PASSIVE FIRE PROTECTION SYSTEMS APPLICATION & TECHNICAL MANUAL.

Light fittings

Light fittings located within a ceiling cavity should normally be enclosed in an adequately supported fire protection box to prevent fire spreading rapidly into the ceiling cavity. Most light fittings will require ventilation in normal use and this consideration should certainly be factored into light box design. Please consult Promat for details.

Access panels & hatches

Where access into a ceiling void is required, panels and hatches will need to be installed. Please refer to [page 117](#) or consult Promat for details.

Conclusion

Most building regulations stipulate limitations on the use of fire protecting suspended ceilings in certain situations. Care should be therefore taken that the use of a suspended ceiling system is acceptable to the approval authorities.

Steel frame components

Components selection

In order to maintain the fire and acoustic performance of Promat ceiling systems, the type of profile used for framing is important. Construction of fire resistant steel framed ceilings can be achieved using standard steel section components. Steel framing may be C or I-sections, furring channels, top hats, trusses or similar members which in all cases should be designed in accordance with BS 5950: 2000, AS 4600: 2005 and/or equivalent standard.

The profiles described in the system specification should be strictly followed at all times. However, the profiles may be amended as long as they possess comparable performances to the specified profiles.

Perimeter tracks & steel joists for self-supporting ceilings

This system is appropriate in most situations, particularly where it is difficult to install a suspended ceiling and/or within narrow rooms or corridors. No hangers are required, creating shorter installation times and provision of a completely free cavity for the accommodation of ductwork and services.

NOTE: For Australia, suitable framing profiles can be obtained from Rondo Building Services who provide comprehensive documentation for ceiling framing systems.

The framing system generally consists of a perimeter track profile and steel joists. During the design stage, choosing the right depth of the profile takes into account the maximum allowable span. The main function of perimeter tracks is to provide friction joints that hold the joists in position until the Promat board is fitted. They also provide allowance for movement of building structure under ambient conditions.

Under fire conditions, perimeter tracks of this nature allow the steel joists to expand, minimising deflection of the ceiling construction that may cause excessive cracking and then delamination of the lining boards. This type of joint is suitable for ceiling membrane systems of up to 3000mm span. Track sections should be fixed to the supporting structure using suitable masonry anchors at maximum 500mm intervals. Fixings should be located not more than 100mm from either end of the track section.

For membrane ceilings with a span of more than 3,000mm, mounting brackets are required at both ends of the steel joists. The mounting brackets will be attached to the wall, at the same time, and shall be designed to allow for expansion of the steel joists.

Please refer to [pages 115 and 116](#) for further details.



Fixing of primary and secondary profiles

- ① Wall U-profile
- ② Horizontal C-profile
- ③ Fixing point

Steel framing system for suspended ceiling

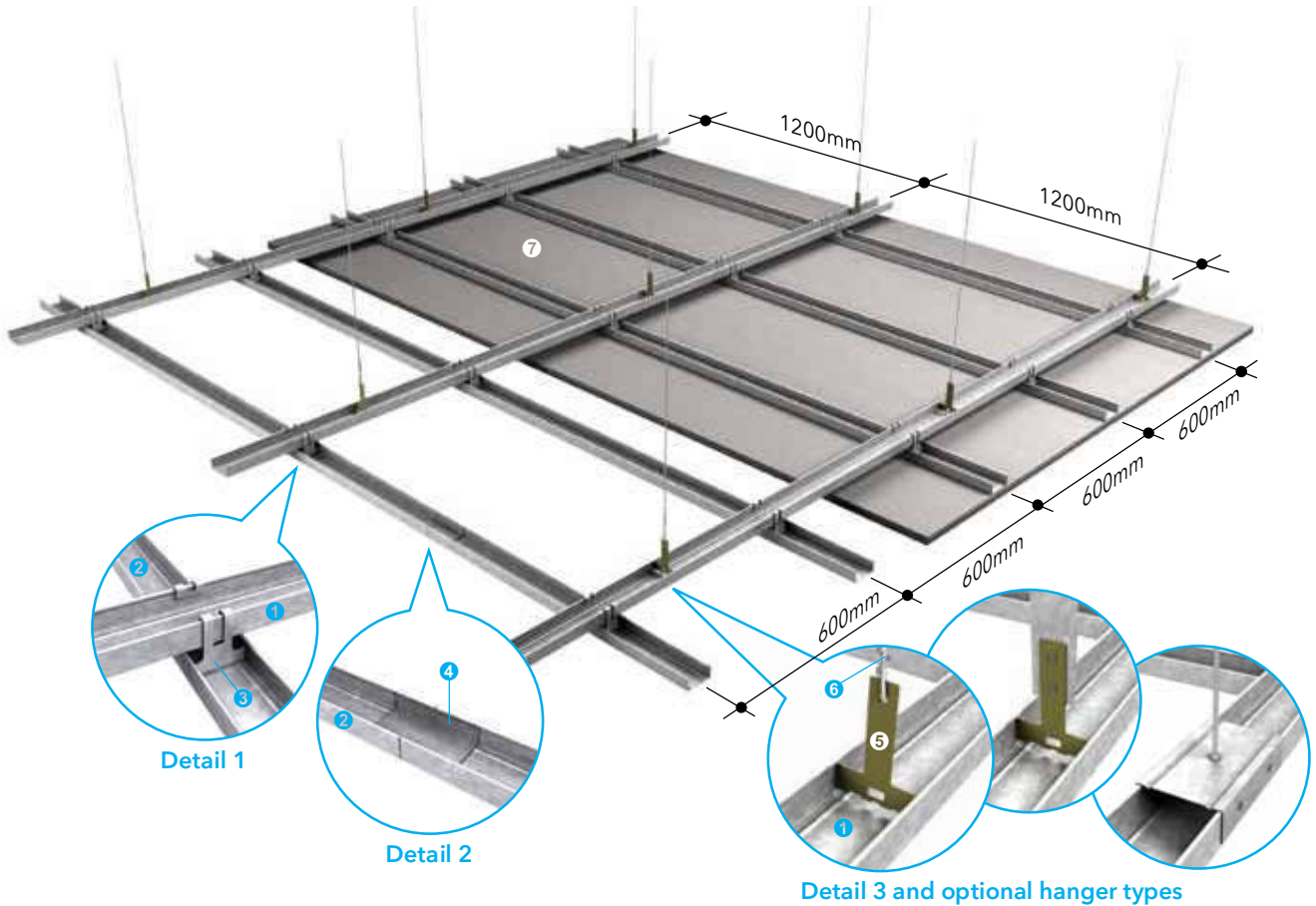

This system is the most appropriate for the installation of large area suspended ceilings. The steel structure of the suspended ceiling is composed of a grid of C-profiles and accessories, made of galvanised steel. The standard length of the C-profile is either 3000mm or 6000mm.





- ① Primary profile
- ② Secondary profile
- ③ Fixing hooks
- ④ Connector
- ⑤ Hanger
- ⑥ Hanger wire
- ⑦ Promat board

NOTE: For details of framing requirements for the installation of access panels and hatches, please refer to the Access Panels section of this handbook.

Typical profiles for ceiling construction

	Type: C-60 profile Dimension: 60mm x 27mm Application: Primary profile, secondary profile or cross profile
	Type: Cross fixer Dimension: 27mm x 55mm x 25mm (0.8mm) Application: Fix cross profile to secondary profile
	Type: Connector Dimension: 27mm x 61.5mm x 100mm (0.8mm) Application: To link two C-60 profiles

	Type: Fixing hooks Dimension: 50mm x 58mm x 0.8mm Application: Fix secondary profile to primary profile
	Type: Cross fixer Dimension: 27mm x 55mm x 25mm (0.8mm) Application: Fix cross profile to ceiling

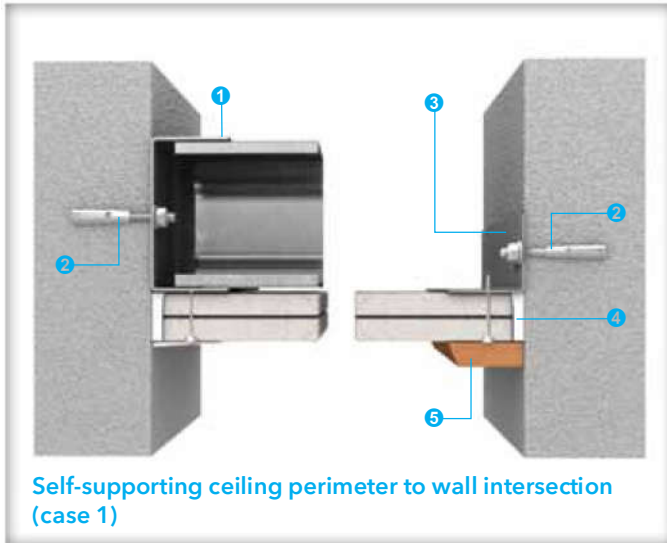

- ① Galvanised steel perimeter channel
- ② 50mm x M6 expansion bolts at 500mm centres
- ③ Galvanised steel perimeter angle
- ④ PROMASEAL®-A Acrylic Sealant to maintain fire and acoustic performance
- ⑤ Ceiling trim or coving to perimeter

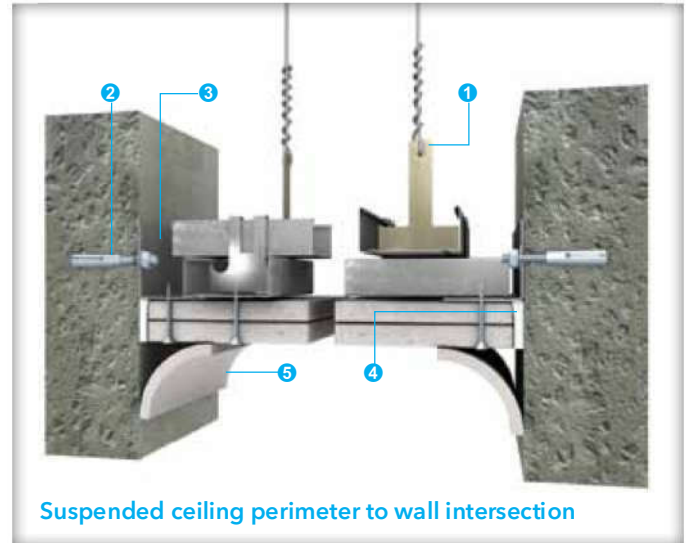

- ① Concealed grid suspended ceiling system
- ② 50mm x M6 expansion bolts at 500mm centres
- ③ Galvanised steel perimeter angle
- ④ PROMASEAL®-A Acrylic Sealant to maintain fire and acoustic performance
- ⑤ Ceiling trim or coving to perimeter

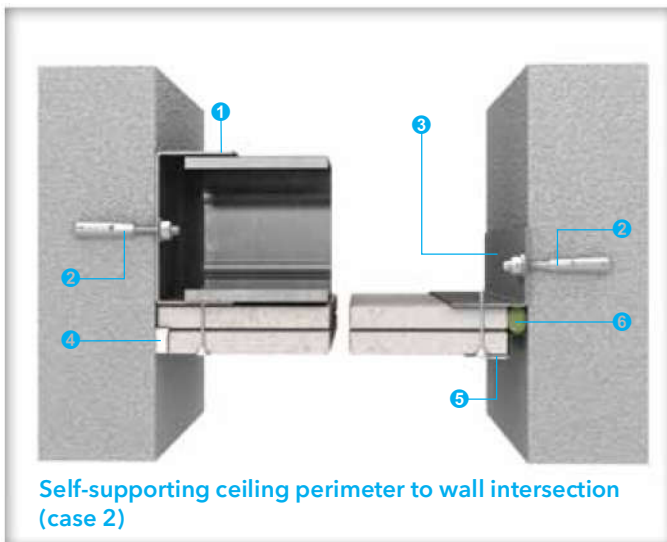

- ① Galvanised steel perimeter channel
- ② 50mm x M6 expansion bolts at 500mm centres
- ③ Galvanised steel perimeter angle
- ④ PROMASEAL®-A Acrylic Sealant to maintain the fire and acoustic performance
- ⑤ RONDO P50 Shadowline Trim and set over
- ⑥ PROMASEAL® IBS™ Ø 22mm diameter to maintain fire performance (not suitable if acoustic integrity is required)

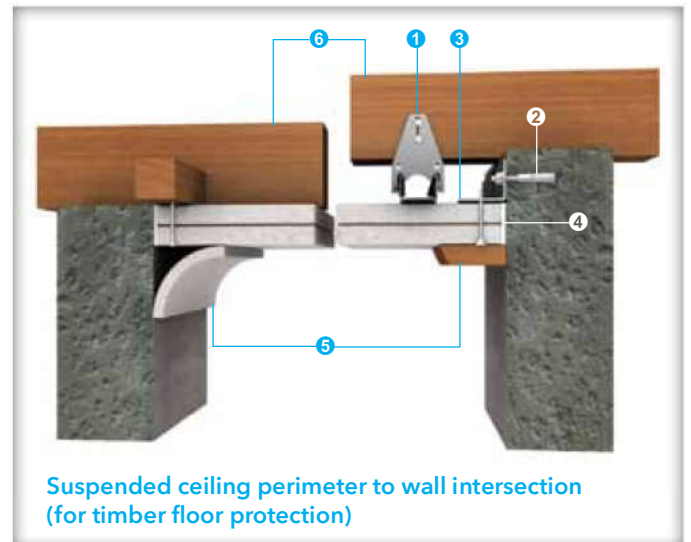

- ① Concealed grid suspended ceiling system
- ② 50mm x M6 expansion bolts at 500mm centres
- ③ Galvanised steel perimeter angle
- ④ PROMASEAL®-A Acrylic Sealant to maintain fire and acoustic performance
- ⑤ Ceiling trim or coving to perimeter
- ⑥ Timber joists etc

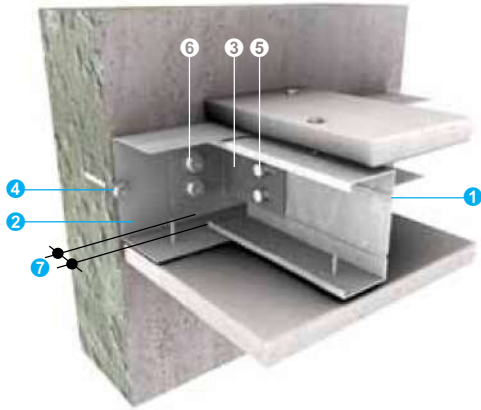

Self-supporting ceiling perimeter framing at masonry wall junction (for ceiling span above 3000mm)

- ① Steel joists at 600mm nominal centres
- ② Galvanised steel perimeter channel
- ③ Galvanised steel angle bracket 3mm thick
- ④ 50mm x M6 expansion bolts at 500mm centres
- ⑤ Two pieces of M8 bolts at each end of joist
- ⑥ Two pieces of 60mm x M8 expansion bolts per bracket
- ⑦ Expansion allowance according to system specification

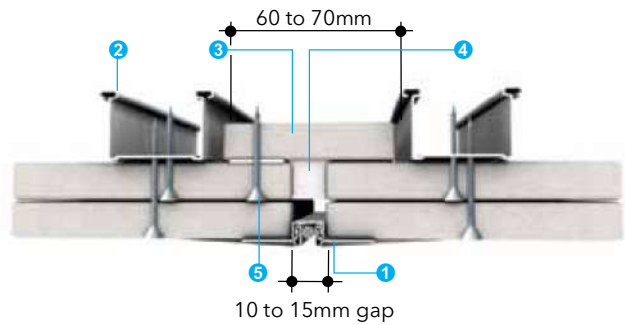

Parallel to steel framing of double layer self-supporting ceilings

- ① RONDO P35 control joint with set finish
- ② Concealed steel grid framing sections
- ③ Continuous Promat board strips
- ④ Continuously fill gap with PROMASEAL®-A Acrylic Sealant to minimum depth of 1st layer board thickness
- ⑤ Fix one side of Promat board strips with laminating screws at 200mm maximum centres or plaster based adhesive

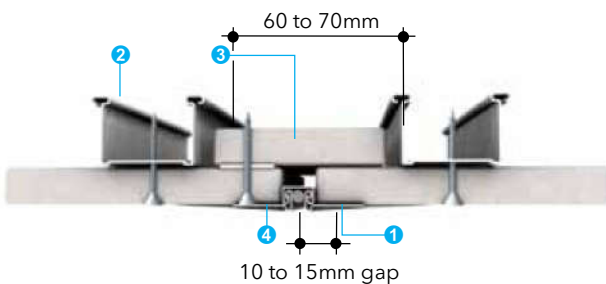

Parallel to steel framing of single layer self-supporting ceilings

- ① RONDO P35 control joint with set finish
- ② Concealed steel grid framing sections
- ③ Continuous Promat board strips
- ④ Fix one side of Promat board strips with laminating screws at 200mm centres

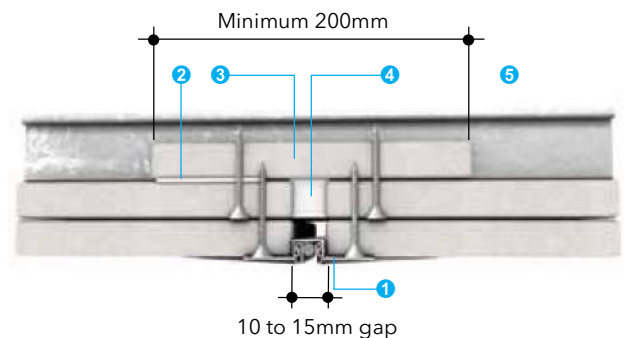

Perpendicular to steel framing of double layer self-supporting ceilings

- ① RONDO P35 control joint with set finish
- ② Fix one side of Promat board strips with laminating screws at 200mm maximum centres or plaster based adhesive
- ③ Promat board strips between galvanised steel channel
- ④ Continuously fill gap with PROMASEAL®-A Acrylic Sealant to minimum depth of 1st layer board thickness
- ⑤ Continuous galvanised steel channel

Ceiling/floor access hatch

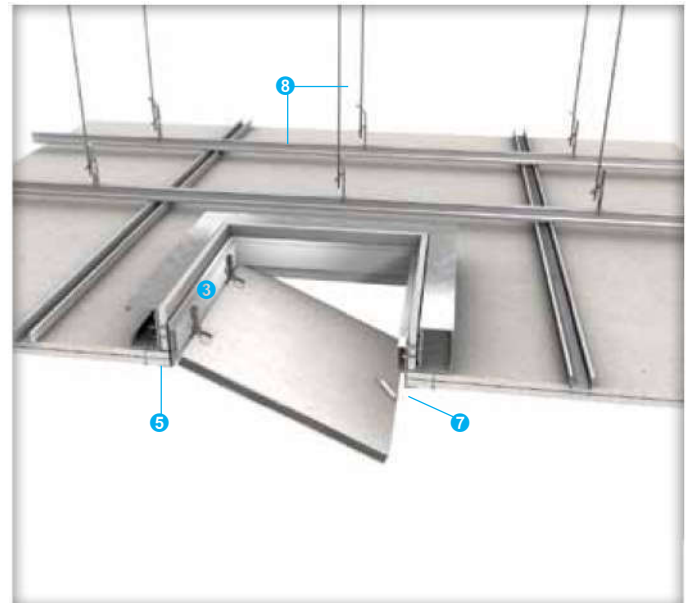
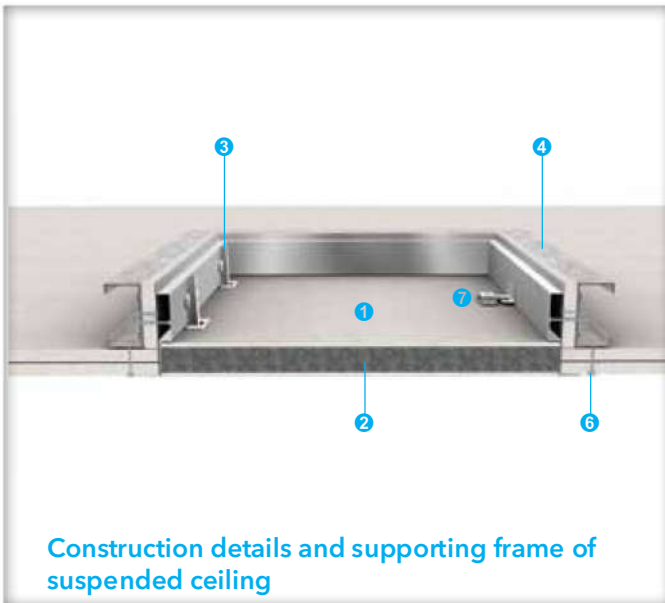
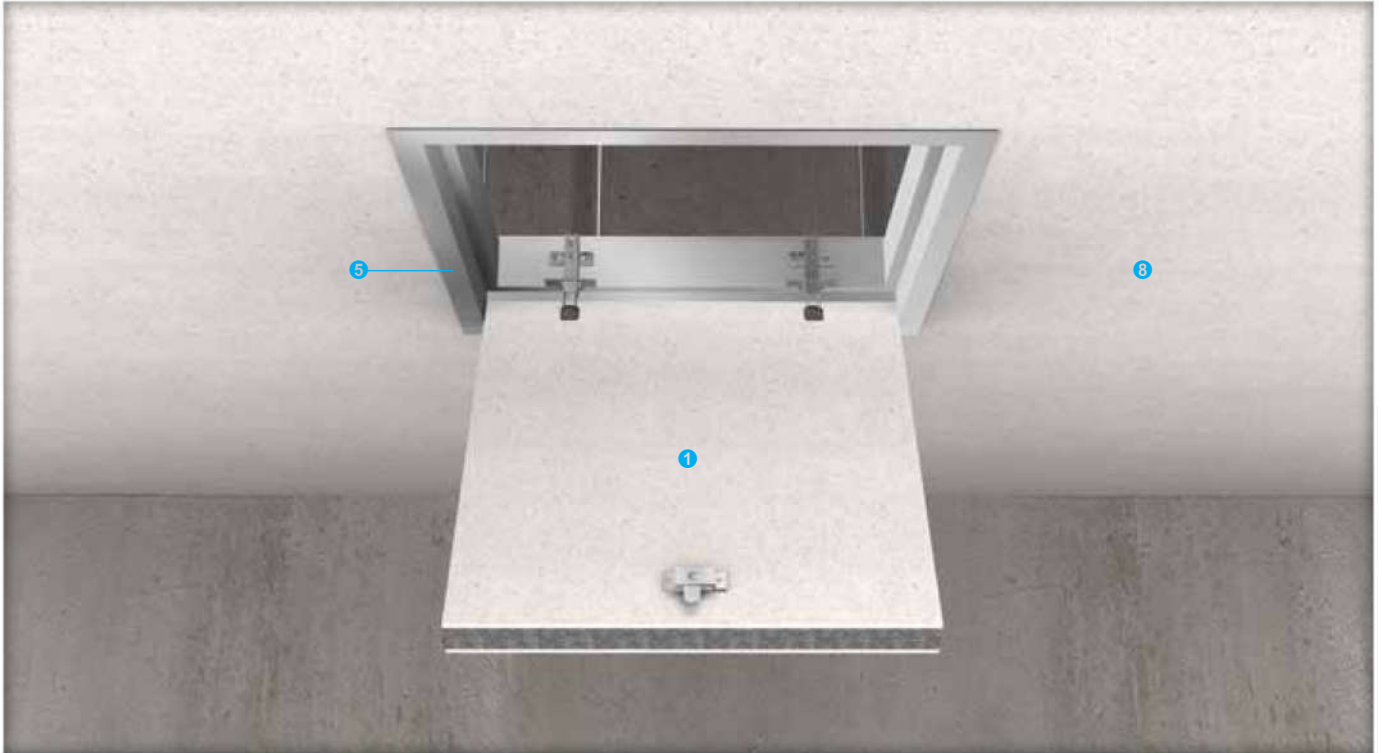

- ❶ PROMATECT® 100 board 30mm thick (maximum size 700mm x 700mm) covered with one layer of medium density fibreboard, 5mm thick on each side
- ❷ PROMASEAL® Intumescent Strip 30mm x 2mm thick at perimeter
- ❸ Access hatch framework with hinges
- ❹ Galvanised steel channel, size in accordance with the existing system of ❸
- ❺ Galvanised steel trimming flange (optional)
- ❻ 75mm self-tapping screws at nominal 250mm centres
- ❼ Lock set, quantity and centres of the locks depend on overall hatch size
- ❽ Fire resistant self-supporting/suspended membrane ceiling or concrete/masonry floor

Fire attack from above / Non loadbearing



Fire resistance	FRL	-/120/120
	Standard	AS 1530: Part 4: 2005
	Approval	BRE CC 232157A
Acoustic	# STC # R _w	36dB 36dB
	Standard	ISO 140: Part 3: 1996 ISO 717: Part 1: 1996
	Predicted assessment	Marshall Day 16th August 2007
Construction	Maximum span	3000mm
	Ceiling thickness	From 150mm
	Ceiling mass	From 39kg/m ²

Margin of error is generally within ±3dB

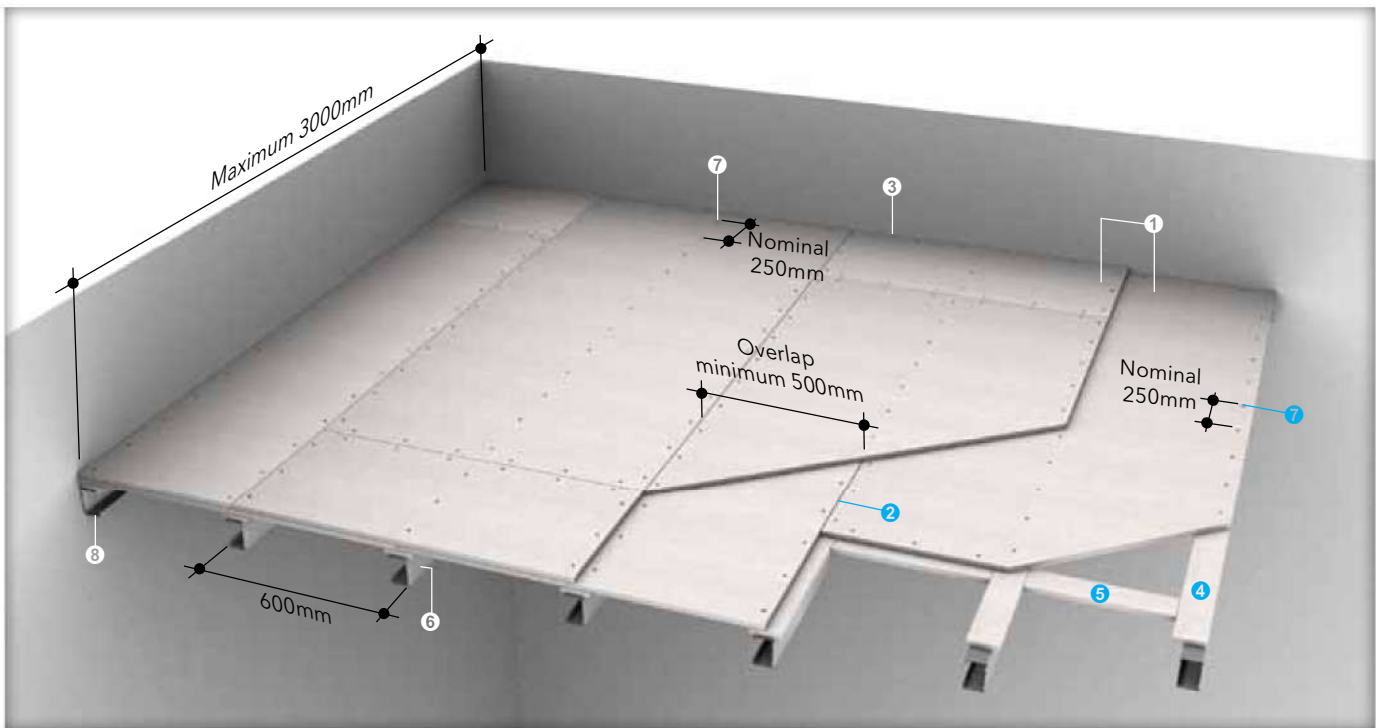

- 1 Two layers of PROMATECT® 100 board, each 20mm thick
- 2 All longitudinal board joints must be coincident with the steel framework, longitudinal board joints between the two layers must be staggered by 500mm
- 3 Gap at perimeter to be caulked with PROMASEAL®-A Acrylic Sealant
- 4 PROMATECT® 100 cover strip 50mm x 20mm thick above of perimeter channel
- 5 PROMATECT® 100 cover strip 50mm x 20mm thick at transverse joints in the first layer
- 6 Steel joist at 600mm centres
- 7 No. 8 steel screws at nominal 250mm centres
 - 32mm long to secure cover strips to steel
 - 50mm long to secure first layer board to steel
 - 72mm long to secure second layer board to steel
 - 35mm long laminating screws to stitch transverse joints in second layer board to first layer board
- 8 Steel wall channel fixed to substrate at nominal 500mm centres

Please see pages 115 and 116 for details of perimeter and control joints

Fire attack from below / Non loadbearing



Fire resistance	FRL	-/120/120
	Standard	AS 1530: Part 4: 2005
	Approval	BRE CC 232157A
Acoustic	# STC # R _w	36dB 36dB
	Standard	ISO 140: Part 3: 1996 ISO 717: Part 1: 1996
	Predicted assessment	Marshall Day 16th August 2007
Construction	Maximum span	3000mm
	Ceiling thickness	From 150mm
	Ceiling mass	From 39kg/m ²

Margin of error is generally within ±3dB

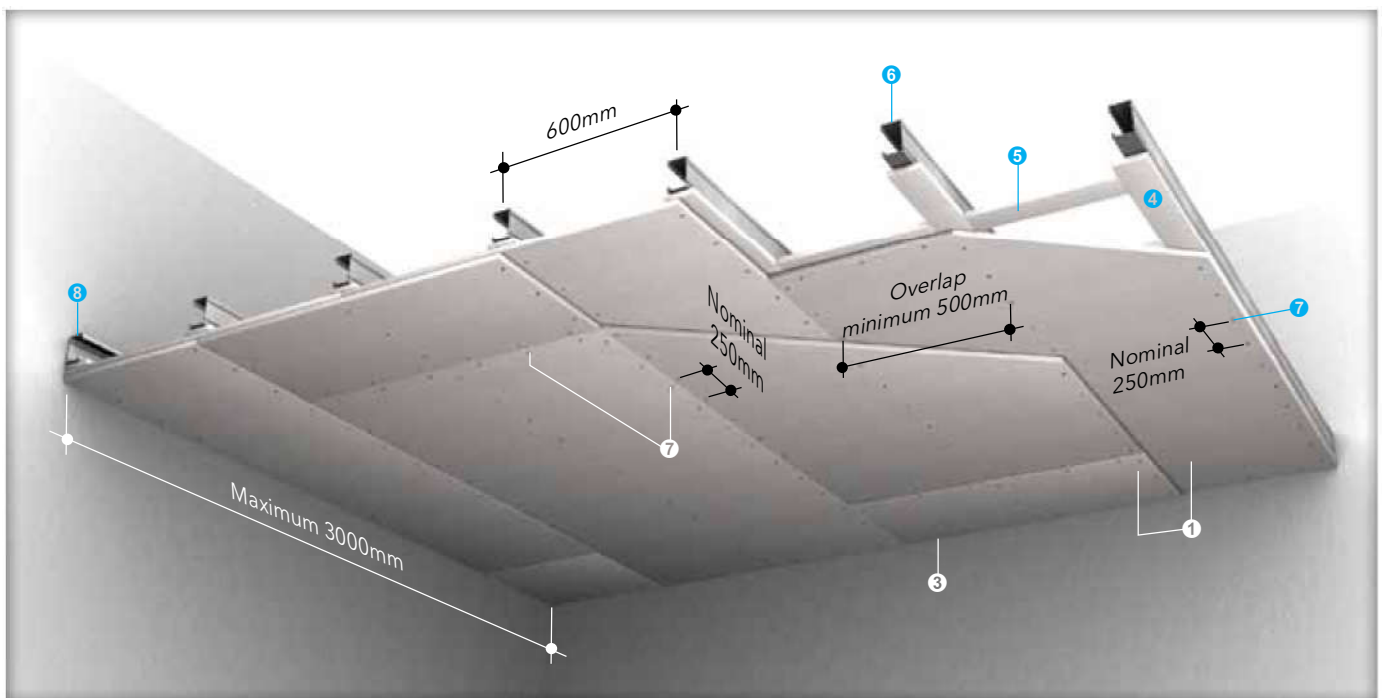

- ① Two layers of PROMATECT® 100 board, each 20mm thick
- ② All longitudinal board joints must be coincident with the steel framework, longitudinal board joints between the two layers must be staggered by 600mm
- ③ Gap at perimeter to be caulked with PROMASEAL®-A Acrylic Sealant
- ④ PROMATECT® 100 cover strip 85mm x 20mm thick
- ⑤ PROMATECT® 100 cover strip 50mm x 20mm thick at transverse joints in the first layer
- ⑥ Steel joist at 600mm centres
- ⑦ No. 8 steel screws at nominal 250mm centres
 - 32mm long to secure cover strips to steel
 - 50mm long to secure first layer board to steel
 - 72mm long to secure second layer board to steel
 - 35mm long laminating screws to stitch transverse joints in second layer board to first layer board
- ⑧ Steel wall channel

Please see pages 115 and 116 for details of perimeter and control joints

Fire attack from above and below / Non loadbearing



Fire resistance	FRL	-/120/120
	Standard	AS 1530: Part 4: 2005
	Approval	CSIRO FCO2515 BRANZ FAR 2885
Acoustic	# STC # R _w	39dB 39dB
	Standard	ISO 140: Part 3: 1996 ISO 717: Part 1: 1996
	Predicted assessment	Marshall Day 16th August 2007
Construction	Maximum span	10,000mm
	Ceiling thickness	From 105mm
	Ceiling mass	From 38.8kg/m ²

Margin of error is generally within $\pm 3\text{dB}$

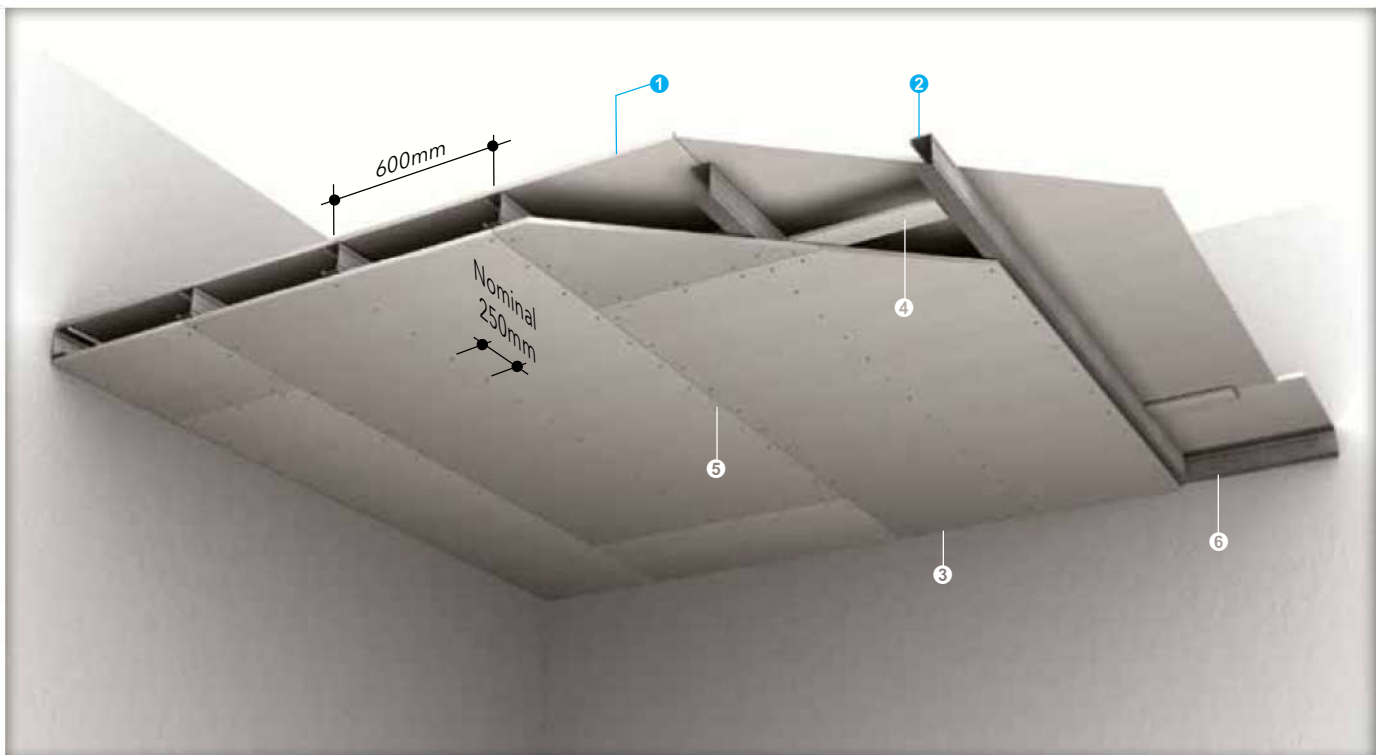

- ❶ PROMATECT® 100 board 20mm thick to each side
- ❷ Steel joists at 600mm nominal centres. For up to 2.5m span, use lipped channel 64mm x 38mm x 13mm x 2.5mm
- ❸ Gap at perimeter to be caulked with PROMASEAL®-A Acrylic Sealant
- ❹ PROMATECT® 100 cover strip 100mm x 20mm thick at transverse joints in the top and bottom boards
- ❺ 35mm long screws
 - No. 8 self tapping/drilling screws at 200mm centres to secure board to steel
 - No. 10 laminating screws at 100mm centres to stitch joints to cover strips
- ❻ Steel wall channel

Please see pages 115 and 116 for details of perimeter and control joints

Fire attack from above and below / Non loadbearing



Fire resistance	FRL	-/240/240
	Standard	AS 1530: Part 4: 2005
	Approval	BRANZ FAR 4283
Acoustic	# STC # R _w	41 dB 41 dB
	Standard	ISO 140: Part 3: 1996 ISO 717: Part 1: 1996
	Predicted assessment	Marshall Day 16th August 2007
Construction	Maximum span	10,000mm
	Ceiling thickness	From 156mm
	Ceiling mass	From 70kg/m ²

Margin of error is generally within ±3dB

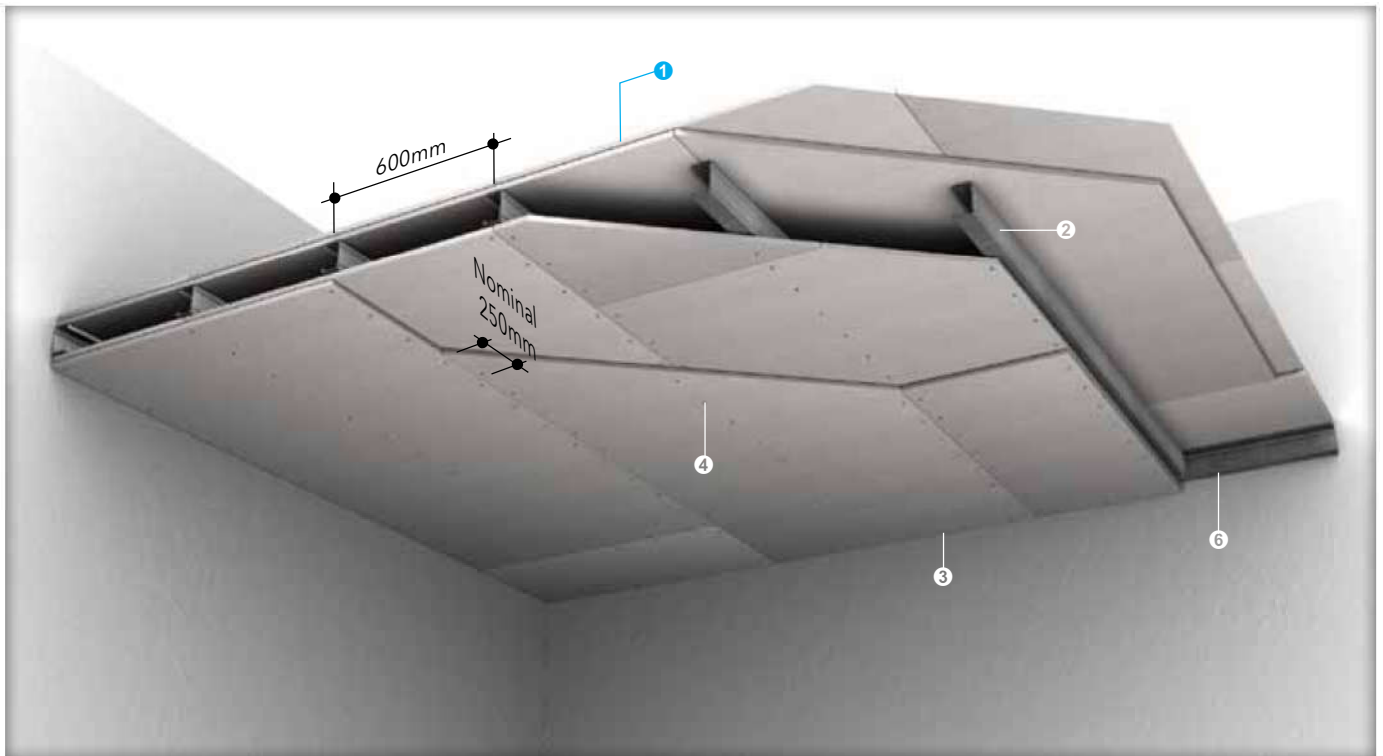

- ① Two layers of PROMATECT® 100 board, each 20mm thick
- ② Steel joists at 600mm nominal centres. For up to 2.5m span, use 92mm x 2.5mm wall stud
- ③ Gap at perimeter to be caulked with PROMASEAL®-A Acrylic Sealant
- ④ 35mm No. 8 self tapping/drilling screws at 300mm centres to secure inner board to steel
40mm No. 10 laminating screws at 100mm centres to stitch joints to steel
50mm No. 8 self tapping/drilling screws at 200mm centres to secure outer board to steel
- ⑤ Steel wall channel

Please see pages 115 and 116 for details of perimeter and control joints

The following are standard Architectural Specifications for self-supporting membrane ceiling systems using PROMATECT® 100. The designer must determine the suitability of the design to the application and requirements before undertaking or constructing any works relating to the specifications and where in doubt should obtain the advice of a suitably qualified engineer.

Fire attack from above / fire attack from below / fire attack from above & below / non loadbearing

Up to 240 minute fire resistance, integrity and insulation in accordance with the criteria of AS 1530: Part 4: 2005. Non loadbearing.

Supporting structure

Care should be taken that any structural element by which the membrane ceiling system is supported, e.g. a beam, floor or wall, has a fire resistance equal to or greater than 120 minutes and is capable of supporting the system for the required fire resistance.

Lining boards

One or two⁽¹⁾ layers of 20mm thick PROMATECT® 100 PromaX® mineral boards as manufactured by Promat International (Asia Pacific) Ltd. All joints to coincide with steel framing. Standard board dimension 1200mm x 2500mm x 20mm thick.

Fixing

Wall tracks are anchored to the wall using 60mm x M6 steel expanding anchors at maximum 500mm centres. Ceiling joists comprising steel lipped channels are then positioned at 600mm maximum centres. The ends of each of the steel joists are friction fitted between the flanges of the steel perimeter channels. Wall tracks and ceiling joists section sizes are to be selected as appropriate, according to the ceiling span outlined in the steel joist table below.

Ceiling span	Proposed steel joist	Proposed wall track
Up to 1.5m	Lipped C-92 x 35mm x 5mm x 0.55mm thick	C-94 x 32mm x 0.55mm thick
Up to 2.0m	Lipped C-92 x 35mm x 5mm x 1.15mm thick	C-94 x 32mm x 0.55mm thick
Up to 2.5m	Lipped C-102 x 51mm x 12.5mm x 1.2mm thick	C-100 x 40mm x 0.6mm thick
Up to 3.0m	Lipped C-102 x 51mm x 12.5mm x 1.5mm thick	C-100 x 40mm x 0.6mm thick

For fire exposure from above, the topside of the steel joists and perimeter channels are covered with 20mm thick PROMATECT® 100 fillets, minimum width 50mm for the perimeter channels and 85mm for the steel joists. The fillets are fixed in position using minimum 32mm x No. 8 screws at 250mm centres. Two layers of 20mm thick PROMATECT® 100 boards are then fixed to the topside of the steel framework and fillets using minimum 50mm x No. 8 screws at maximum 250mm centres. All longitudinal board joints must be coincident with the steel framework. The second layer is fixed in a similar manner using minimum 72mm x No. 8 screws, ensuring that all joints in the two layers are staggered by 600mm. Each transverse joints in second layer are fixed using 35mm laminating screws.

For the fire exposure from below, the PROMATECT® 100 boards and fixing are similar to the above but the boards are laid at the bottom of the steel joists and perimeter channels.

As for the fire exposure from either side, 20mm thick PROMATECT® 100 is fixed to either side of the steel joists and perimeter channels. The fixing uses 32mm x No. 8 screws at 200mm centres. One layer of PROMATECT® 100 cover strip 100mm x 20mm thick is fixed at transverse board joints in the top and bottom boards. The stitch joints at the cover strips are then fixed using No. 10 laminating screws.

Ceiling span	Proposed steel joist	Rondo Part No.	Lysaght Part No.	Minimum sectional modulus	Expansion at each end of steel section
Up to 1.5m	C-channel 65mm x 50mm x 0.6mm thick	251 (493)	C10010	2314mm ³	9mm
Up to 2.0m	C-channel 65mm x 50mm x 1.15mm thick	511 (681)	C10010	4330mm ³	12 mm
Up to 2.5m	Lipped C-channel 65mm x 38mm x 13mm x 2.5mm thick	511 (691)	C10010	7110mm ³	15mm
Up to 3.0m	Lipped C-channel 76mm x 44mm x 16mm x 2.5mm thick	691	C10015	10300mm ³	18mm
Up to 3.5m	C-channel 103mm x 34mm x 3.0mm thick	N/A	C10019	12840mm ³	21mm
Up to 4.0m	Lipped C-channel 102mm x 51mm x 18mm x 2.5mm thick	N/A	C15015	17400mm ³	24mm
Up to 5.0m	Two back to back lipped C-channel 102mm x 51mm x 18mm x 2.5mm thick	N/A	C20015	34800mm ³	30mm
Up to 6.0m	Two back to back lipped C-channel 127mm x 51mm x 18mm x 2.5mm thick	N/A	C20024	46800mm ³	36mm
Up to 7.4m	Lipped C-channel 203mm x 76mm x 24mm x 3.0mm thick	N/A	C20024	70100mm ³	45mm
Up to 8.3m	Lipped C-channel 250mm x 75mm x 20mm x 2.3mm thick	N/A	C20024	91600mm ³	50mm
Up to 9.0m	Two back to back lipped C-channel 225mm x 75mm x 20mm x 2.3mm thick	N/A	C30030	124360mm ³	55mm
Up to 10.0m	Two back to back lipped C-channel 250mm x 75mm x 20mm x 3.0mm thick	N/A	C30030	183200mm ³	60mm

Tests & standards

The complete system along with material and framing is tested and/or assessed to meet the requirements of AS 1530: Part 4: 2005.

Follow-on trades

Surface of boards to be prepared for painting/plastering/tiling⁽⁵⁾ in accordance with manufacturer's recommendations.

Fire attack from below / Loadbearing

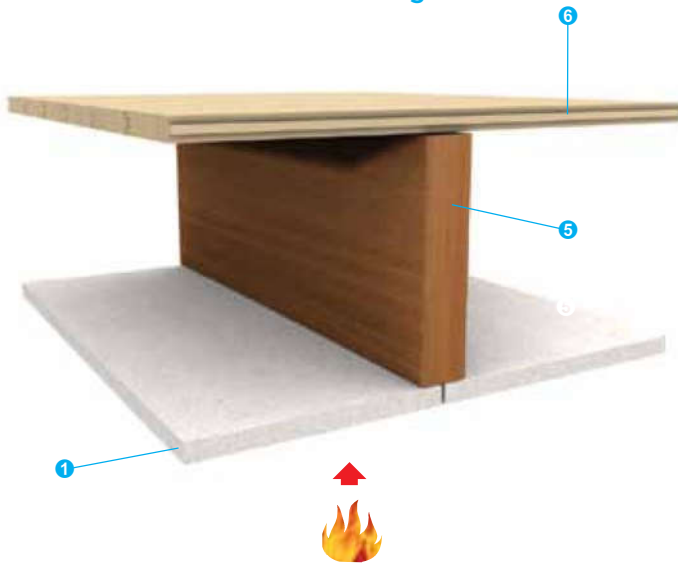

Fire resistance	FRL	60/60/60
	Standard	AS 1530: Part 4: 2005
	Approval	BRANZ FAR 2886
Acoustic	# STC # R _w	43dB 43dB
	Standard	ISO 140: Part 3: 1996 ISO 717: Part 1: 1996
	Predicted assessment	Marshall Day 20th August 2007
Construction	Maximum span	3000mm
	Ceiling thickness	267mm
	Ceiling mass	35kg/m ²

Margin of error is generally within $\pm 3\text{dB}$

* Based on nominal weight of the board

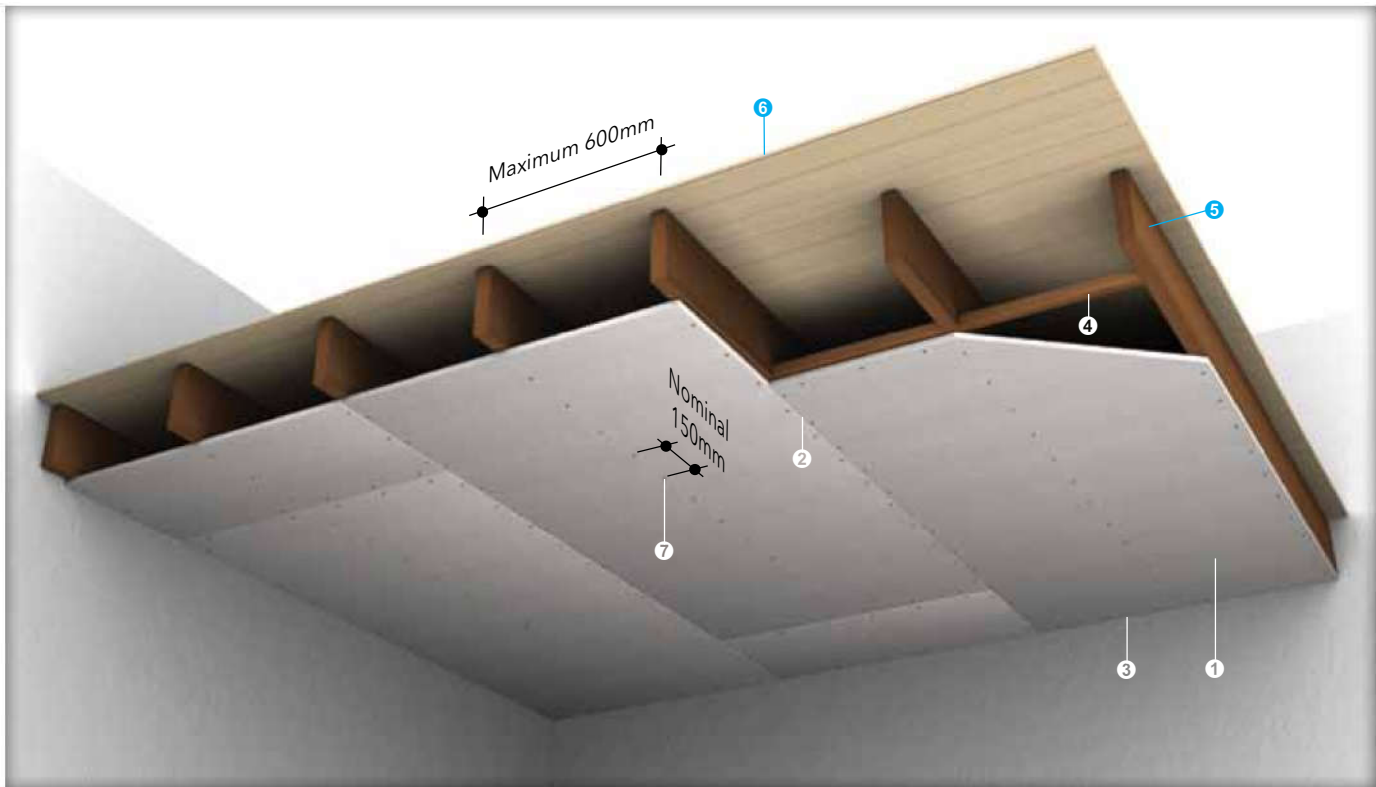

- ❶ PROMATECT® 100 board 20mm thick
- ❷ Longitudinal board joints to coincide with timber joists
- ❸ Gap at perimeter to be caulked with PROMASEAL®-A Acrylic Sealant
- ❹ Timber noggling 38mm x 38mm at 1250mm centres and to coincide with transverse board joints
- ❺ Timber joist minimum 225mm x 48mm at maximum 600 centres
- ❻ Tongue-and-groove floorboards 22mm thick
- ❼ 50mm long galvanised clout nails or woodscrews at nominal 150mm centres

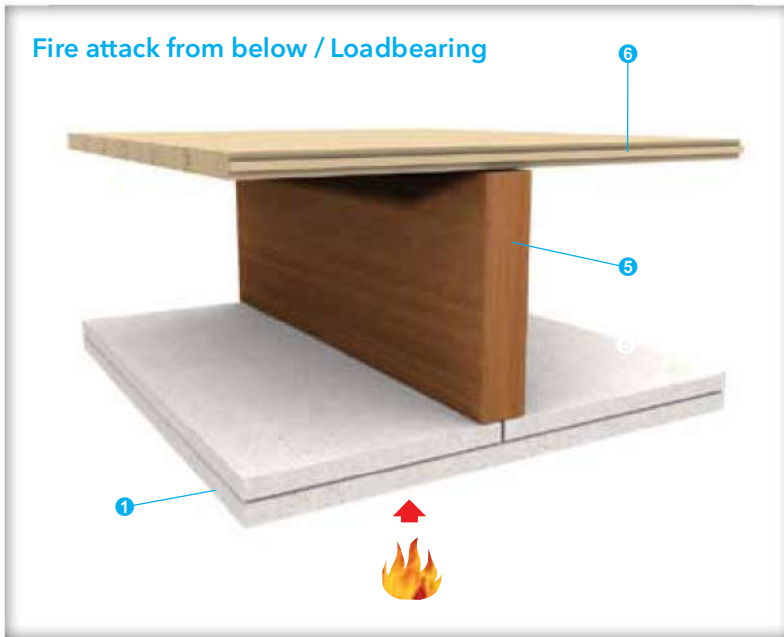

Fire resistance	FRL	90/90/90
	Standard	BS 476: Part 21: 1987
	Approval	LPC TE90019
Acoustic	# STC	43dB
	# R _w	43dB
	Standard	ISO 140: Part 3: 1996 ISO 717: Part 1: 1996
Construction	Predicted assessment	Marshall Day 20th August 2007
	Maximum span	3000mm
	Ceiling thickness	267mm
	Ceiling mass	36kg/m ²

Margin of error is generally within $\pm 3\text{dB}$
* Based on nominal weight of the board

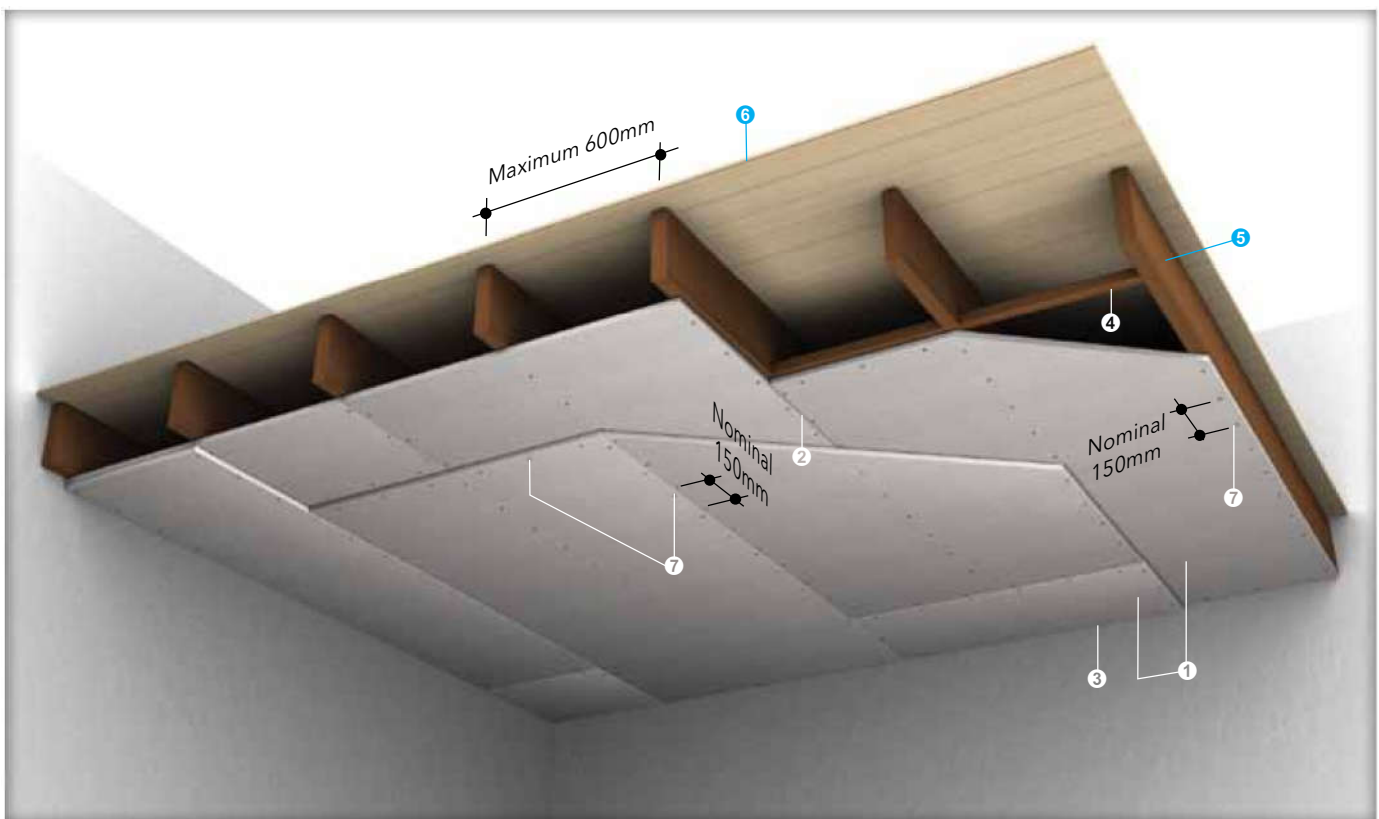

- 1 Two layers of PROMATECT® 100 board, each 10mm thick
- 2 Longitudinal board joints to coincide with timber joists, longitudinal board joints between the 2 layers must be staggered by 600mm
- 3 Gap at perimeter to be caulked with PROMASEAL®-A Acrylic Sealant
- 4 Timber nogging 38mm x 38mm at 1250mm centres and to coincide with transverse board joints in the 1st layer
- 5 Timber joist minimum 225mm x 48mm at maximum 600 centres
- 6 Tongue-and-groove floorboards 22mm thick
- 7 50mm long galvanised clout nails or woodscrews at nominal 150mm centres

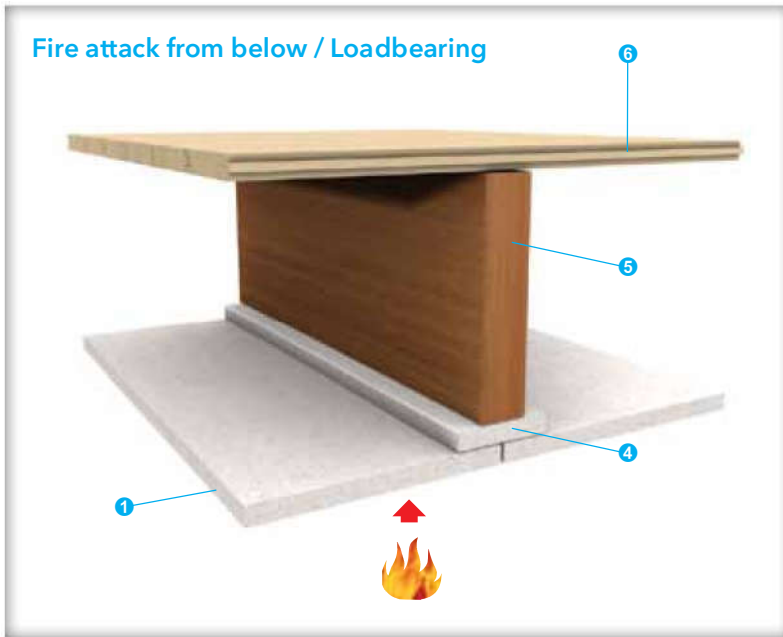

Fire resistance	FRL	90/90/90
	Standard	AS 1530: Part 4: 2005
	Approval	BRANZ FAR 2886
Acoustic	# STC # R _w	43dB 43dB
	Standard	ISO 140: Part 3: 1996 ISO 717: Part 1: 1996
	Predicted assessment	Marshall Day 20th August 2007
Construction	Maximum span	3000mm
	Ceiling thickness	287mm
	Ceiling mass	18.4kg/m ²

Margin of error is generally within $\pm 3\text{dB}$
* Based on nominal weight of the board

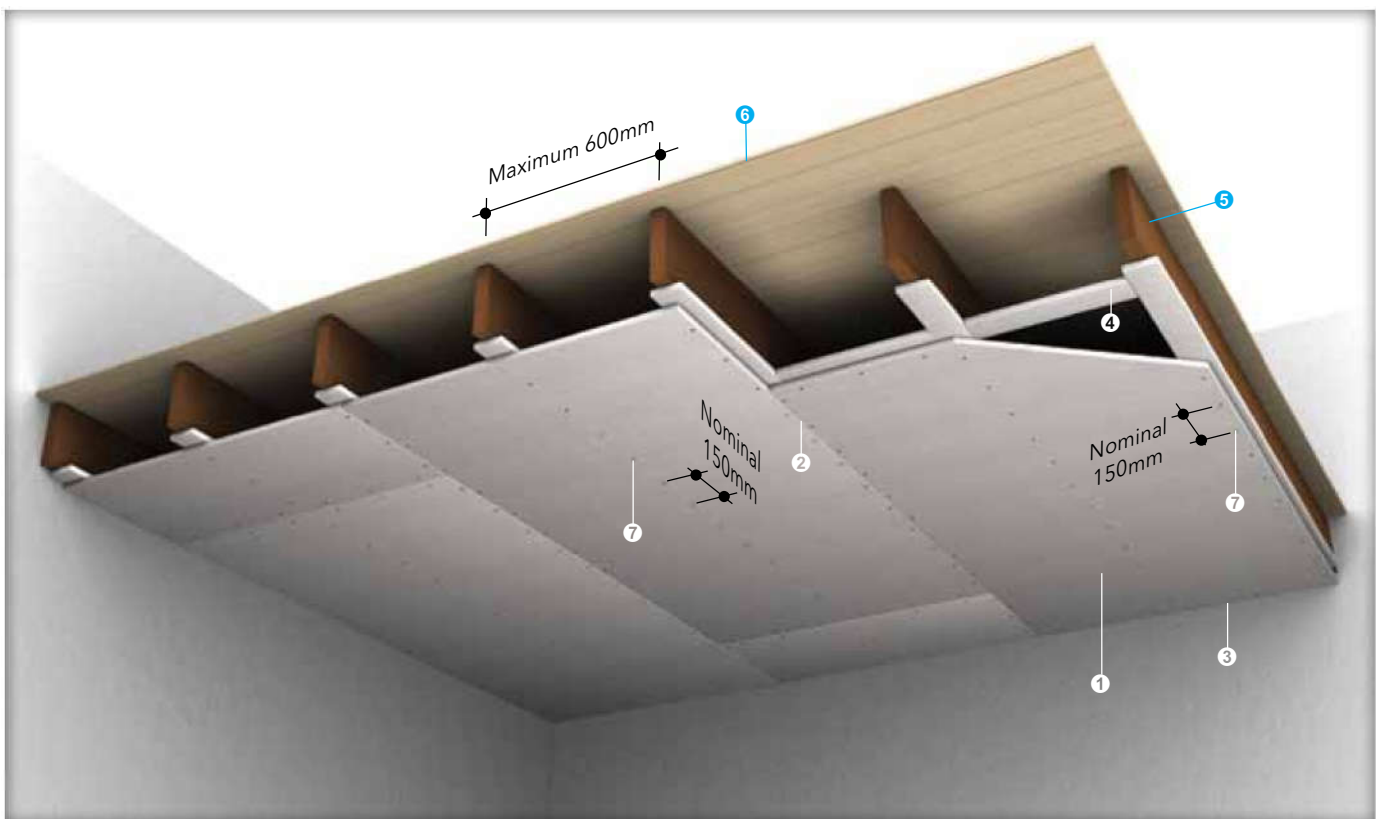

- ❶ One layers of PROMATECT® 100 board 20mm thick
- ❷ Longitudinal board joints to coincide with timber joists
- ❸ Gap at perimeter to be caulked with PROMASEAL®-A Acrylic Sealant
- ❹ PROMATECT® 100 cover strip 100mm x 20mm thick located on all joists and transverse board joints
- ❺ Timber joist minimum 225mm x 48mm at maximum 600 centres
- ❻ Tongue-and-groove floorboards 22mm thick
- ❼ 50mm long galvanised clout nails or woodscrews at nominal 150mm centres

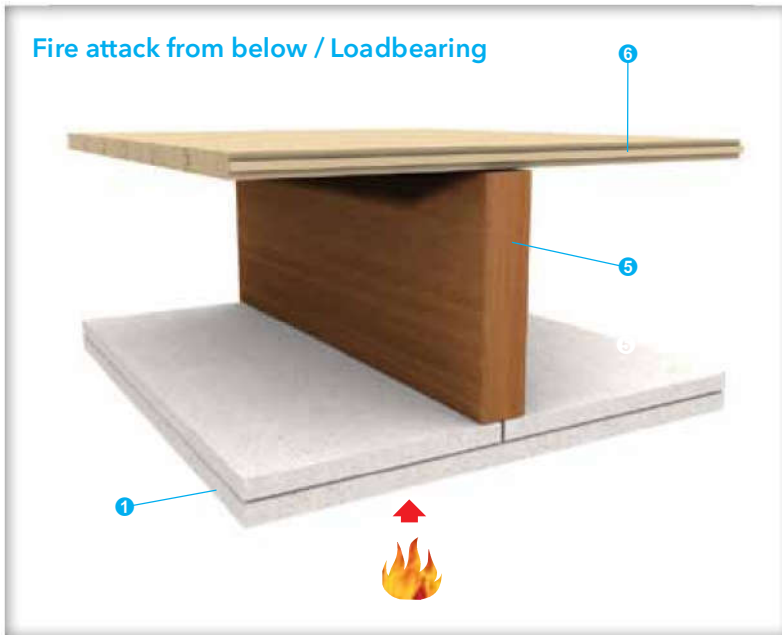

Fire resistance	FRL	120/120/120
	Standard	AS 1530: Part 4: 2005
	Approval	BRANZ FAR 2924
Acoustic	# STC	43dB
	# R _w	43dB
	Standard	ISO 140: Part 3: 1996 ISO 717: Part 1: 1996
Construction	Predicted assessment	Marshall Day 20th August 2007
	Maximum span	3000mm
	Ceiling thickness	287mm
	Ceiling mass	52.6kg/m ²

Margin of error is generally within ± 3 dB
* Based on nominal weight of the board

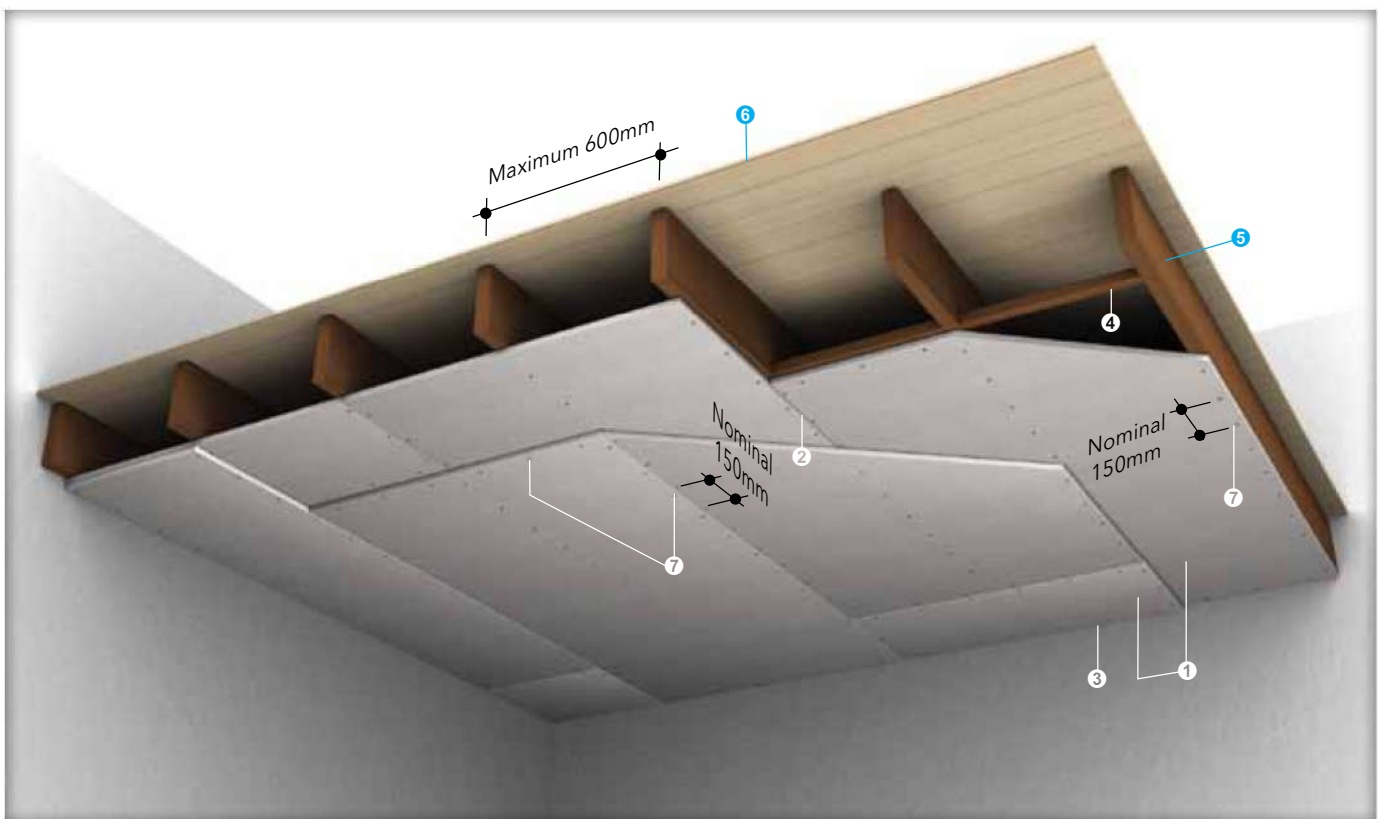

- 1 Two layers of PROMATECT® 100 board, each 20mm thick
- 2 Longitudinal board joints to coincide with timber joists, longitudinal board joints between the 2 layers must be staggered by 600mm
- 3 Gap at perimeter to be caulked with PROMASEAL®-A Acrylic Sealant
- 4 Timber noggling 38mm x 38mm at 1250mm centres and to coincide with transverse board joints in the 1st layer
- 5 Timber joist minimum 225mm x 48mm at maximum 600 centres
- 6 Tongue-and-groove floorboards 22mm thick
- 7 50mm long galvanised clout nails or woodscrews at nominal 150mm centres for first layer, 75mm long for second layer.

The following are standard Architectural Specifications for timber floor protection systems using PROMATECT® 100. The designer must determine the suitability of the design to the application and requirements before undertaking or constructing any works relating to the specifications and where in doubt should obtain the advice of a suitably qualified engineer.

Fire attack from below / loadbearing

Up to _____ minute⁽¹⁾ fire resistance, loadbearing capacity, integrity and _____ minute⁽²⁾ insulation in accordance with the criteria of BS 476: Part 21: 1987.

Supporting structure

Care should be taken that any structural element by which the floor protection system is supported, e.g. a beam, floor or wall, has a fire resistance equal to or greater than _____ minutes⁽¹⁾ and is capable of supporting the system for the required fire resistance.

Lining boards

Either one or two⁽³⁾ layers of 20mm or two layer of 10mm thick PROMATECT® 100 PromaX® mineral boards as manufactured by Promat International (Asia Pacific) Ltd. All joints to be coincident with steel framing. Standard board dimension 1200mm x 2500mm x 10mm or 20mm⁽³⁾ thick.

Fixing

Timber floor comprising of timber joists, 225mm x 48mm, at 600mm centres with tongue-and-groove chipboard flooring of 22mm thickness. Timber cross noggings, 38mm x 38mm, are to be located between the joists and spaced at 1250mm intervals such that they coincide with the transverse 60 minutes joints of the first layer of the PROMATECT® 100 boards.

For 60 minute fire resistance, one layer of 20mm thick PROMATECT® 100 is fixed to the timber framework using either galvanised clout nails or woodscrews of 50mm long at nominal 150mm centres, and a minimum of 12mm from board edge.

For 90 minute fire resistance, first layer of PROMATECT® 100 boards is fixed to the timber framework using either galvanised clout nails or woodscrews of 50mm long at nominal 150mm centres, and a minimum of 12mm from the board edge. The second layer of PROMATECT® 100 boards is then lined against the first layer and fixed to the timber framework with 50mm long nails or screws in a similar manner.

For 120 minute fire resistance, first layer of PROMATECT® 100 boards is fixed to the timber framework using either galvanised clout nails or woodscrews of 50mm long at nominal 150mm centres, and a minimum of 12mm from the board edge. The second layer of PROMATECT® 100 boards is then lined against the first layer and fixed to the timber framework with 75mm long nails or screws in a similar manner.

Tests & standards

The complete system along with material and framing is tested and/or assessed to meet the requirements of BS 476: Part 21: 1987 or AS 1530: Part 4: 2005.

Jointing

Plain butt joints between machined edges of boards. ⁽⁴⁾

Joints filled in preparation for painting. ⁽⁵⁾

Joints filled and taped in preparation for decoration. ⁽⁶⁾

Follow-on trades

Surface of boards to be prepared for painting/plastering/tiling⁽⁷⁾ in accordance with manufacturer's recommendations.

NOTES:

- ⁽¹⁾ insert required fire resistance level not exceeding 120 minutes.
- ⁽²⁾ insert required insulation level not exceeding the fire resistance level⁽¹⁾.
- ^{(3), (4), (5), (6), (7)} delete as appropriate.
- All perimeter gaps caulked with PROMASEAL®-A Acrylic Sealant.

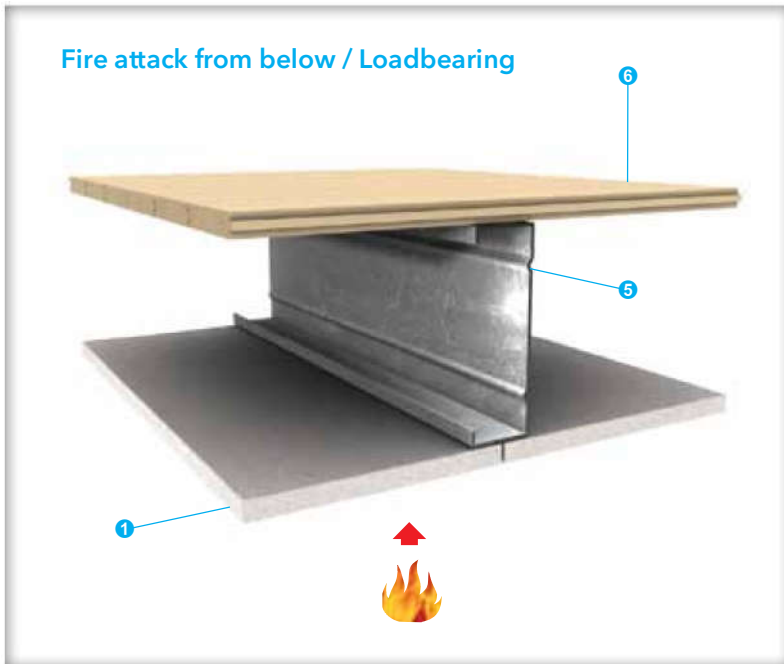

Fire resistance	FRL	60/60/60
	Standard	AS 1530: Part 4: 2005
	Approval	BRE CC 237274
Acoustic	# STC # R _w	36dB 36dB
	Standard	ISO 140: Part 3: 1996 ISO 717: Part 1: 1996
	Predicted assessment	Marshall Day 20th August 2007
Construction	Floor thickness	253mm
	Floor mass	From 19.44kg/m ²

Margin of error is generally within ±3dB

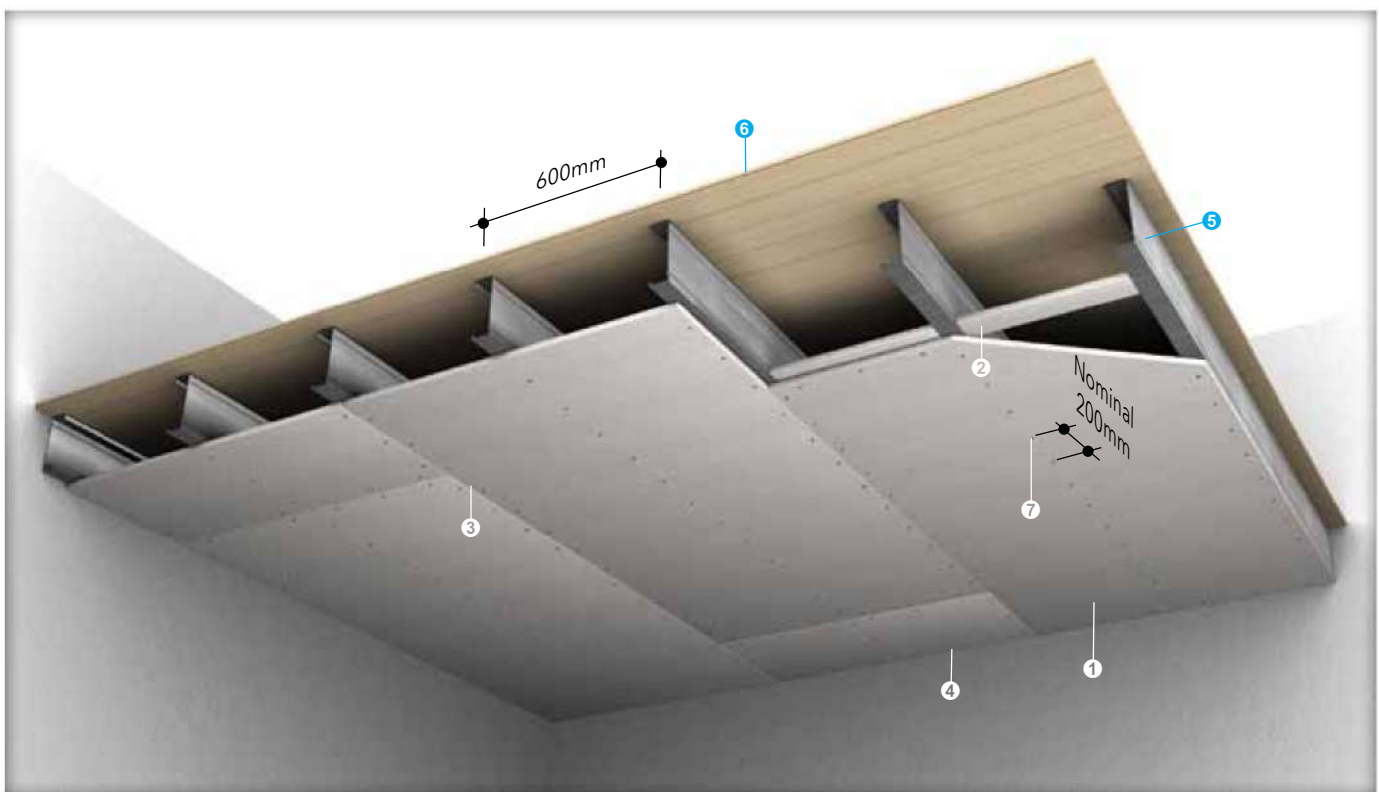

- ① PROMATECT® 100 board 20mm thick
- ② PROMATECT® 100 cover strip 100mm wide x 20mm thick located behind transverse board joint
- ③ Longitudinal board joint to coincide with steel framework
- ④ Gap at perimeter to be caulked with PROMASEAL®-A Acrylic Sealant
- ⑤ Steel joist channel 200mm x 65mm x 15mm x 1.5mm thick at 600mm centres
- ⑥ Tongue-and-groove floorboards 38mm thick
- ⑦ 35mm x No. 8 steel screws at nominal 200mm centres along all joists

Fire attack from below / Loadbearing

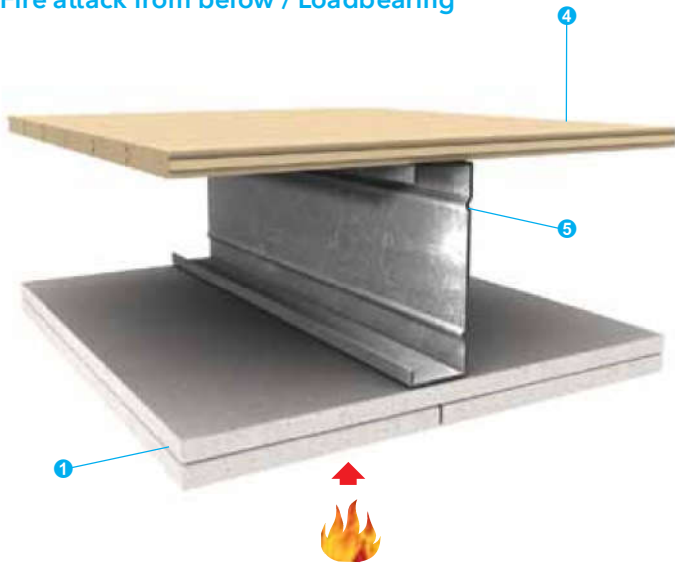

Fire resistance	FRL	120/120/120
	Standard	AS 1530: Part 4: 2005
	Approval	BRE CC 234729
Acoustic	# STC # R _w	39dB 39dB
	Standard	ISO 140: Part 3: 1996 ISO 717: Part 1: 1996
	Predicted assessment	Marshall Day 20th August 2007
Construction	Floor thickness	278mm
	Floor mass	52kg/m ²

Margin of error is generally within ±3dB

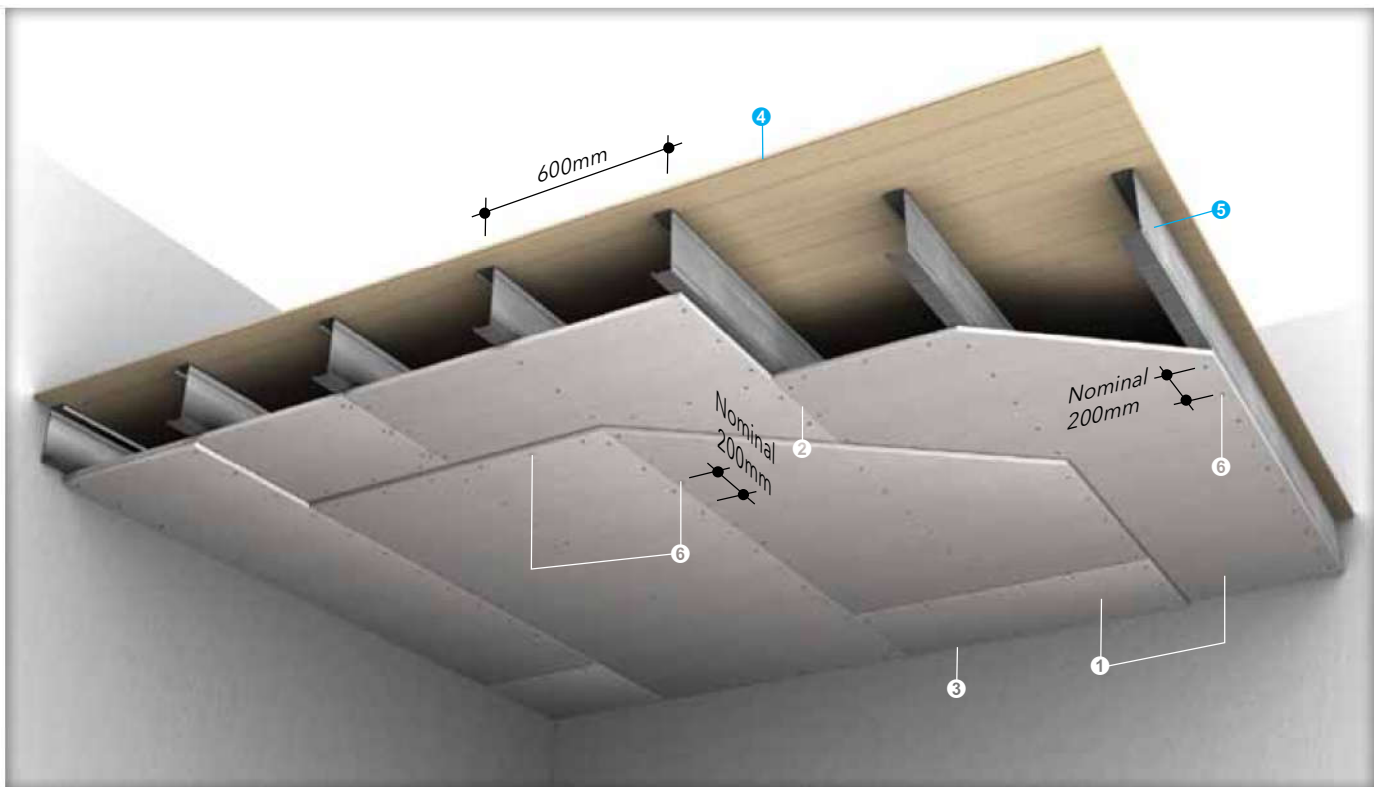

- ① Two layers of PROMATECT® 100 board, each 20mm thick
- ② All longitudinal board joints must be coincident with the steel framework, longitudinal board joints between the 2 layers must be staggered by 600mm.
- ③ Gap at perimeter to be caulked with PROMASEAL®-A Acrylic Sealant
- ④ Tongue-and-groove floorboards 38mm thick
- ⑤ Steel channel 200mm x 65mm x 15mm x 1.5mm thick at 600mm centres
- ⑥ No. 8 steel screws at nominal 200mm centres along all joists
 - 35mm long to screw first layer to joists
 - 50mm long to screw second layer to joists

The following are standard Architectural Specifications for mezzanine floor systems using PROMATECT® 100. The designer must determine the suitability of the design to the application and requirements before undertaking or constructing any works relating to the specifications and where in doubt should obtain the advice of a suitably qualified engineer.

Fire attack from below / loadbearing

Up to _____ minute⁽¹⁾ fire resistance, loadbearing capacity, integrity and _____ minute⁽²⁾ insulation in accordance with the criteria of AS 1530: Part 4: 2005.

Supporting structure

Care should be taken that any structural element by which the mezzanine floor system is supported, e.g. a beam, floor or wall, has a fire resistance equal to or greater than _____ minutes⁽¹⁾ and is capable of supporting the system for the required fire resistance.

Lining boards

One or two⁽³⁾ layers of 20mm thick PROMATECT® 100 PromaX® mineral boards as manufactured by Promat International (Asia Pacific) Ltd. All joints to be coincident with steel framing. Standard board dimension 1200mm x 2500mm x 20mm thick.

Fixing

Mezzanine floor comprising of steel joists, 200mm x 65mm x 15mm x 1.5mm, at 600mm centres with tongue-and-groove chipboard flooring of 38mm thickness.

The first layer of PROMATECT® 100 boards is fixed to the steel framework using 35mm x No. 8 steel screws at nominal 200mm centres, and a minimum of 12mm from the board edge. Where required, one layer of PROMATECT® 100 cover strips 100mm wide x 20mm thick is located behind the transverse board joints. The second layer of PROMATECT® 100 boards, where required, is then lined against the first layer and fixed to the steel framework with 50mm x No. 8 steel screws at nominal 200mm centres.

Tests & standards

The complete system along with material and framing is tested and/or assessed to meet the requirements of AS 1530: Part 4: 2005.

Jointing

Plain butt joints between machined edges of boards. ⁽³⁾
 Joints filled in preparation for painting. ⁽⁴⁾
 Joints filled and taped in preparation for decoration. ⁽⁵⁾

Follow-on trades

Surface of boards to be prepared for painting/plastering/tiling⁽⁶⁾ in accordance with manufacturer's recommendations.

NOTES:

- ⁽¹⁾ insert required fire resistance level not exceeding 120 minutes.
- ⁽²⁾ insert required insulation level not exceeding the fire resistance level⁽¹⁾.
- ^{(3), (4), (5), (6)} delete as appropriate.
- All perimeter gaps caulked with PROMASEAL®-A Acrylic Sealant.





FAQ's and Promat systems in Australia



FAQ's

Q1. Is PROMATECT® 100 cheaper than the conventional plasterboard systems?

A. Overall system costs must be treated as that, a SYSTEM COST. This not only includes materials, but also the labour to install them. With the PROMATECT® 100 system, labour rates can be cut by up to 40% and more importantly, the project can be completed much quicker before moving on to another profitable project.

Q2. How quick can I get PROMATECT® 100?

A. Immediately. We have stock in every state of Australia and can provide you with the material you require on short notice. We understand the needs of today's contractor and will always strive to meet these expectations. Promat Australia has a proud history of a high level of service which we always strive to maintain.

Q3. What technical support can you provide?

A. Our trained and experienced sales staff can provide certification as well as helpful advice on construction methods and other aspects of our system. Our systems are fully designed for the Australian market and are fully compliant to Australian Standards. Therefore PROMATECT® 100 should be the board of choice for your fire rated barriers.

Q4. What kind of finish will I get with the PROMATECT® 100 system?

A. The finish will be as good as or better than plasterboard and is finished using the same techniques you will already be familiar with.

Q5. Do we need any mineral wool infills?

A. No.

Q6. How come only one layer is needed on each side when plasterboard needs two or three?

A. PROMATECT® 100 is a very different board to plasterboard and has superior performance as it is a dedicated fire resistance board and not a hybrid version of non fire rated combustible material.

Q7. Is it cost competitive to gypsum board alternatives?

A. It is a one layer system either side of steel stud providing up to 120 minute protection. Competitor systems are required to use two layers either side. Labour rates are therefore cut in half making PROMATECT® 100 a competitive alternative.

Q8. What surface finish am I likely to achieve if PROMATECT® 100 is used?

A. You will have a finish that is extremely close if not better than gypsum. The PROMATECT® 100 comes with rebated edges, that allows it to be set. PROMATECT® 100 can be painted and used as a finished surface.

Promat system in Australia

PROMATECT® board systems:

- Air Ducts, plenums and enclosures
- M&E Ducts and trunking
- Ceilings and floor protection
- Concrete, timber and steel protection
- Hatches and Panels

PROMASTOP® firestopping systems:

- Pillows
- Mortar
- Sealants
- IBS open cell foam rod and strip
- Fyrestrip - high movement gap seals
- Collars for plastic pipes
- Slab service penetration formers

Brochures:

- Passive Fire Protection Application & Technical Manual
- Promat Australia Contractors Guide: Builders
- Promat Australia Contractors Guide: Electricians
- Promat Australia Contractors Guide: HVAC
- Promat Australia Contractors Guide: Plumbers
- PROMATECT® 250 PROMAXON® Technology Steelwork Fire Protection
- Tunnel Fire Protection Handbook
- Promat SYSTEMPANEL™ Quick Solutions for Fire Resistant Party Walls, Ceilings and Floors
- Fire Stopping Training Manual
- The Specifiers Guide to Fire Rated Hatches and Access Panels
- PROMASTOP® Fire Stopping Jacket
- PROMASEAL® WRAP Insulation Seals for Copper Pipes and Cable Trays
- PromaSnap® Floor Waste System

For information on any of the above applications or specialist advice on

- Custom systems
- Infrastructure
- Energy
- High temperature insulation
- Marine
- Offshore
- Process engineering

Please contact your local Promat Australia office listed on the back cover.

Promat Australia Pty Ltd

Head office

1 Scotland Road
Mile End South, SA 5031
T 1800 PROMAT (776 628)
F +61 (8) 8352 1014
E PAPT.Mail@etexgroup.com

New South Wales office

Unit 1, 175 Briens Road
Northmead, NSW 2152
T 1800 PROMAT (776 628)
F +61 (2) 9630 0258
E PAPT.Mail@etexgroup.com

Victoria office

Unit 1, 355 Grieve Pde
Altona North, VIC 3025
T 1800 PROMAT (776 628)
F 1800 334 598
E PAPT.Mail@etexgroup.com

Queensland office

80 Stradbroke St
Heathwood, QLD 4110
T 1800 011 376
F 1800 334 598
E PAPT.Mail@etexgroup.com

- The technical data provided in this publication is based on mean values prevalent at time of publication and is thus subject to fluctuation. It should not be regarded as a guarantee to system performance.
- All data contained herein conforms to and frequently surpasses generally accepted fire protection standards recognised by most professional fire science practitioners and regulatory authorities worldwide. The same general principle is equally applicable to all Promat products and systems. Promat has access to a considerable body of test authentication data and this can be provided on a complimentary basis upon request. It should be noted however that this publication replaces all previous editions in its entirety. Any form of reproduction by any means – manual, electronic, digital or otherwise – is strictly prohibited and subject to prior approval in writing from Promat. All rights related or connected to the Promat logo, Promat registered trademarks, featured illustrations, written information and technical reports in this publication are the sole, exclusive and copyright property of Promat and its legal partner companies.

www.promat.com

Your local Promat supplier

Etex is a Belgian industrial group that specialises and markets high quality building materials and systems. Founded since 1905 and headquartered in Brussels, Belgium, Etex currently operates in 123 factories and 116 subsidiaries across 44 countries, employs more than 18,000 people and is one of the largest fibre cement producers in the world.

Through its subsidiaries, the group offers an extensive range of products: small and large roofing materials, cladding and building boards, passive fire protection systems and ceramic tiles.

Etex aims to be a professional, solid partner for all kinds of building projects.

