

Promat

The Passive Fire Protection Handbook

The UK's comprehensive guide to passive fire protection

Chapter 4 Ceilings, Floors and Roofs

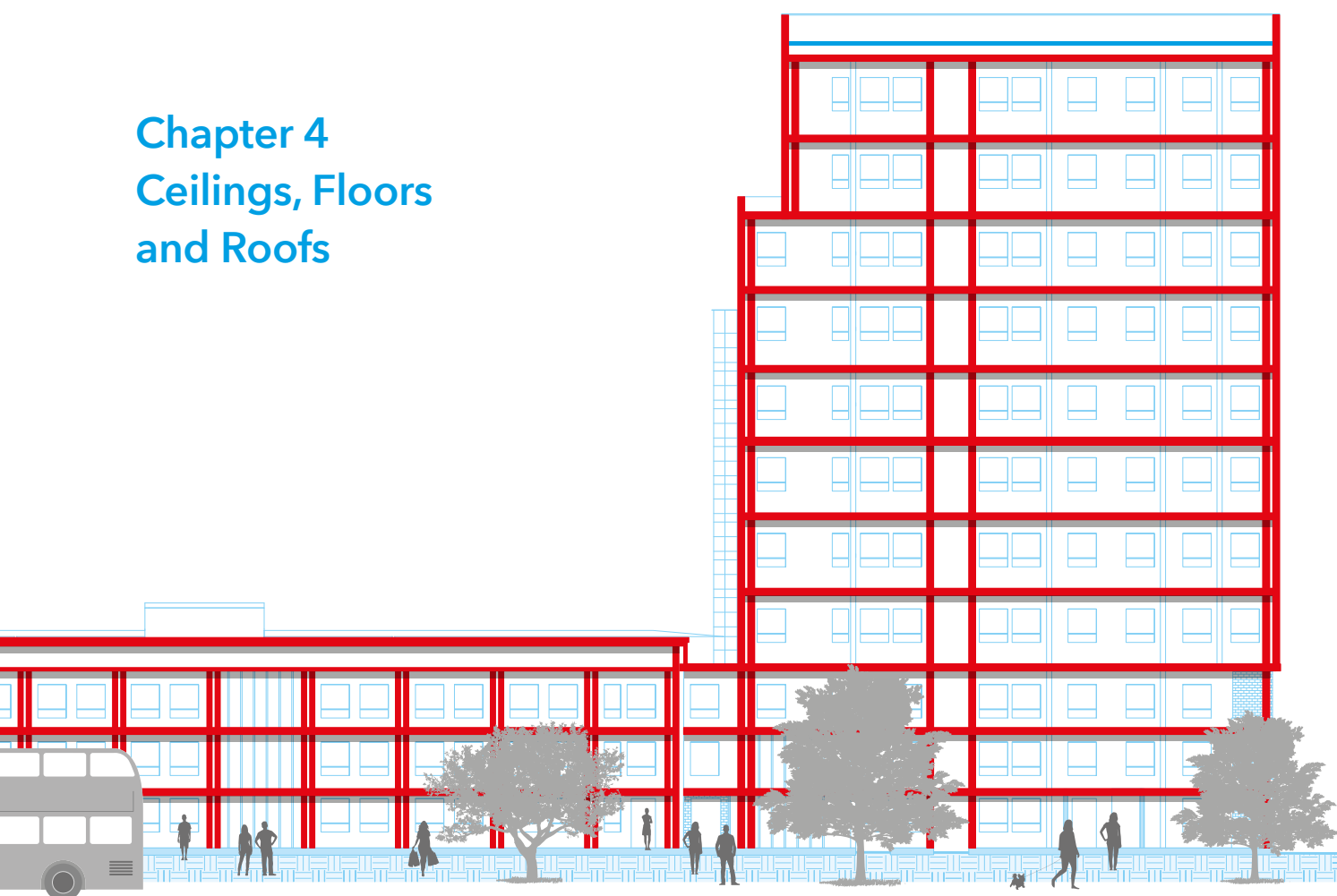

FEBRUARY 2023



Contents

Chapter 4: Ceilings, Floors and Roofs..... 105

Introduction106

Timber Floors and Roofs.....107

Mezzanine Floors117

Protection to Concrete Floor Slabs.....119

Suspended Ceilings120

Self-Supporting Ceiling Membranes...128

Suspended Ceilings, Promat DURASTEEL®131

Promat SUPALUX® Protected Zones....134

Promat SUPALUX® Protected Zones, E60, EI15.....135

Promat SUPALUX® Protected Zones, E120, EI15136

Promat SUPALUX® Protected Zones, E240, EI30137

Chapter 4: Ceilings, Floors and Roofs
Ceilings, Floors and Roofs

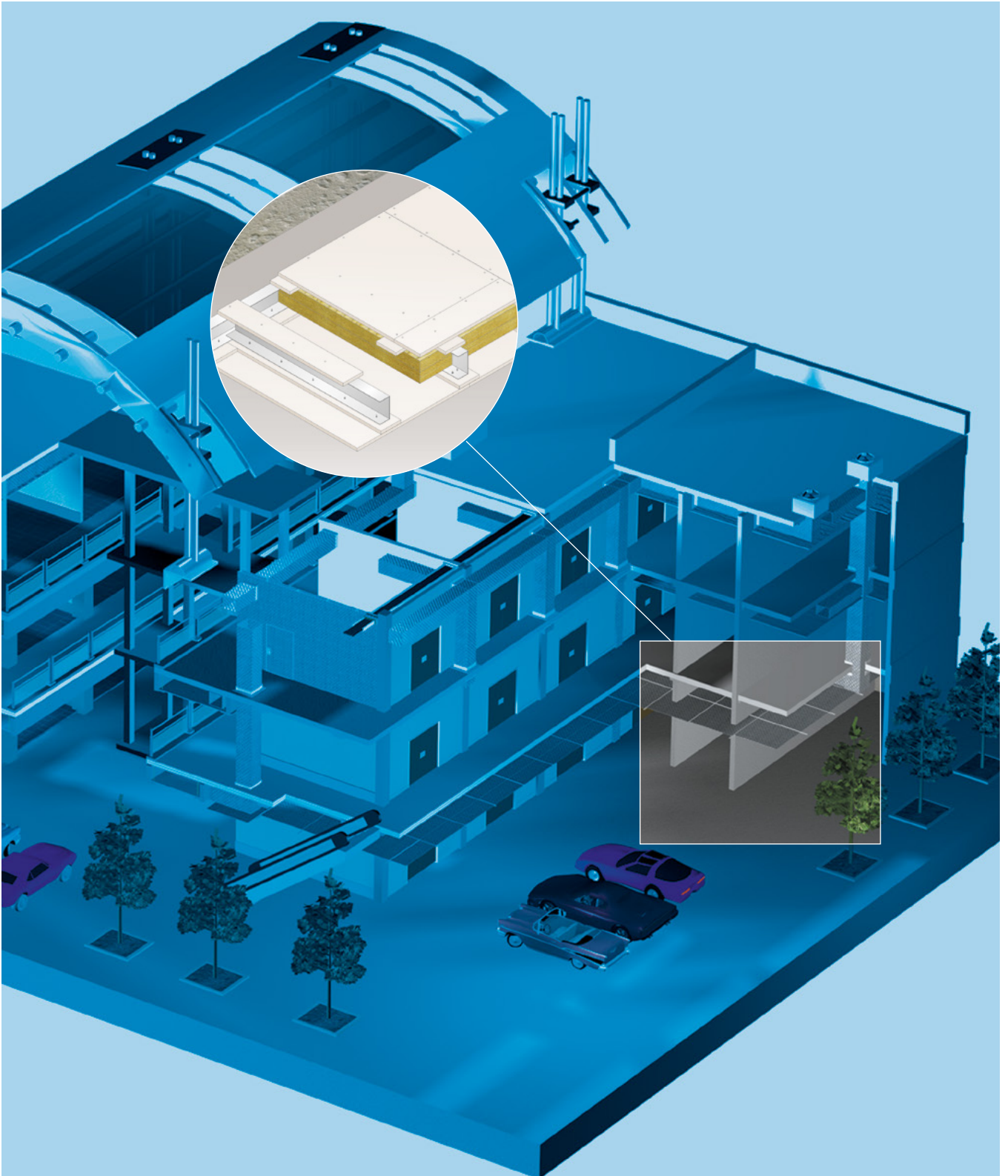

Introduction



Note: In the following pages guidance will be given on most of these topics. Further advice can be obtained from the Promat Technical Services Department.

DESIGN CONSIDERATIONS

The following points should be considered when determining the correct specification to ensure a timber floor will provide the required fire performance:

1. Timber Joist Width

The wider the joist the more bearing the fire protection panel has to be secured to and therefore will perform better in fire conditions.

2. Timber Joist Depth

The deeper the joist the deeper the air cavity and the longer the heat will take to pass through the structure.

3. Timber Joist Spacing

The further apart the joists, the greater distance the ceiling lining will have to span and therefore the more onerous the conditions in fire.

4. Timber Flooring

The timber type, thickness and jointing are all critical.

5. Suspended Ceilings

The distance between the underside of the timber joists and the suspended ceiling protecting the floor is critical. Normally, the greater the air cavity between the ceiling and floor, the better the fire performance.

6. Light Fittings

Light fittings located within a ceiling cavity normally require to be enclosed in an adequately supported fire protection box to prevent fire spreading quickly into the ceiling cavity. Most light fittings will require ventilation in normal use, and this should be considered in the light box design.

7. Service Penetrations

Care needs to be taken in detailing a suitable fire stopping system around any penetration of the floor by services to ensure:

- a) the fire stopping material remains in situ
- b) fire and smoke do not penetrate the floor cavity which ultimately will lead to premature collapse of the joists and/or penetration of fire and smoke through the timber flooring.

8. Cavity Barriers

Building Regulations specify where cavity barriers are required.

9. Engineered Timber Joists

Engineered or laminated joists should be treated differently to solid timber joists. Please contact the Promat Technical Services Department for further information.

NEW CEILING LINING

Timber floors should normally be tested or assessed in accordance with BS 476: Part 21: 1987 and are required to satisfy the three failure criteria of loadbearing capacity, integrity and insulation when exposed to fire from below.

BBA Certificate 18/5593

TECHNICAL DATA

30 minutes fire rating, loadbearing capacity, integrity and insulation in accordance with the criteria of BS 476: Part 21: 1987.

1. Promat MASTERBOARD® boards, 6mm thick.
2. Timber noggings may be required behind transverse joints for decorative purposes only.
3. 50mm nails.
4. Clout nails or similar, 50mm long at nominal 200mm centres.
5. M6 steel anchor bolt at nominal 600mm centres.
6. Flooring, minimum 19mm thick T & G boarding.
7. Timber joists, minimum 225mm x 38mm at maximum 610mm centres.
8. Timber batten, 50mm x 50mm.

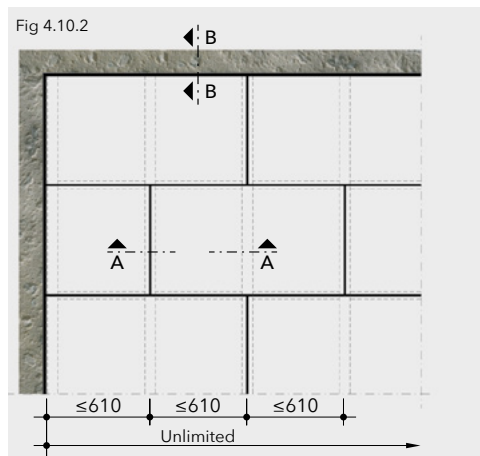
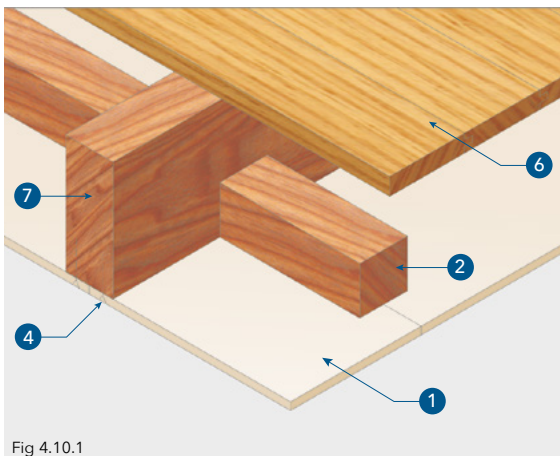

Detail 1 - Plan

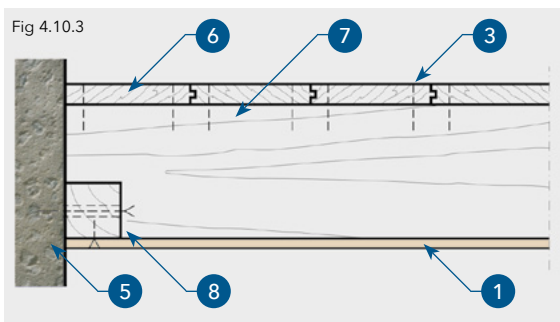

Detail 3 - Wall connection (Section B-B)

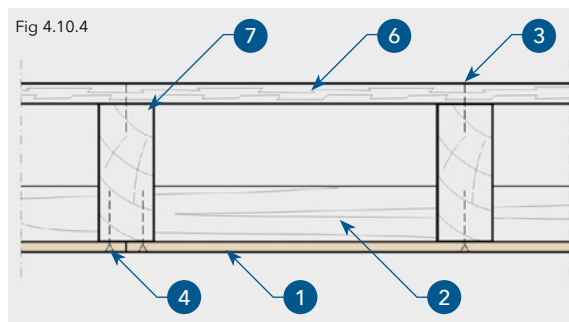

Detail 2 - Fixing to the underside of joists (Section A-A)

Certifire Approval No CF 420

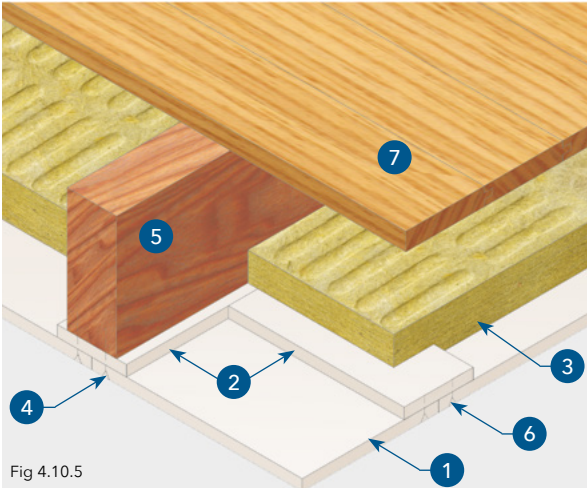

Fig 4.10.5

NEW CEILING LINING

TECHNICAL DATA

60 minutes fire rating, loadbearing capacity, integrity and insulation in accordance with the criteria of BS 476: Part 21: 1987.

1. Promat SUPALUX® boards, 9mm thick.
2. Promat SUPALUX® fillet/coverstrip, 80mm x 9mm.
3. Rock wool, minimum 30mm x 60 kg/m³ or 60mm x 23 kg/m³.
4. 75mm nails (with heads) at 200mm centres or M4 x 63mm long steel woodscrews at 300mm centres.
5. Timber joists, minimum 130mm x 38mm at maximum 610mm centres.
6. Cover strips at lateral board joints should be fastened using M4 x 25mm long self-tapping screws at nominal 300mm centres on both sides of joint.
7. T & G or square-edged flooring, minimum 19mm thick. Secure 4.8mm hardboard over square-edged floorboards.

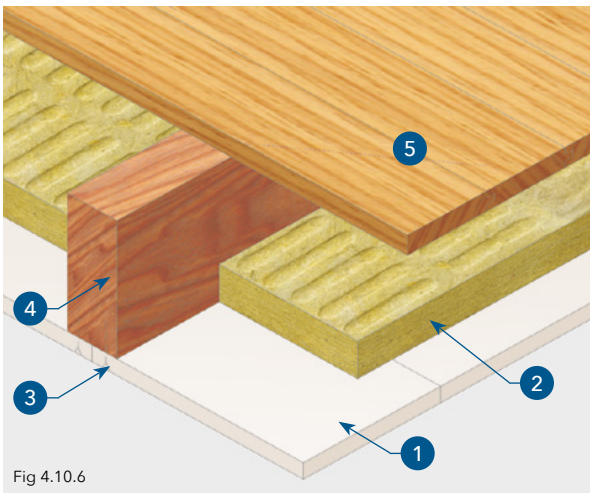

Fig 4.10.6

TECHNICAL DATA

60 minutes fire rating, loadbearing capacity, integrity and insulation in accordance with the criteria of BS 476: Part 21: 1987.

1. Promat SUPALUX® boards, 12mm thick.
2. Rock wool, minimum 30mm x 60 kg/m³.
3. 75mm nails (with heads) at 200mm centres or M4 x 63mm long steel woodscrews at 300mm centres.
4. Timber joists, minimum 150mm x 50mm at maximum 610mm centres.
5. T & G or square-edged flooring, minimum 19mm thick.
6. Secure 4.8mm hardboard over square-edged floorboards.

NEW CEILING LINING

TECHNICAL DATA

60 minutes fire rating, loadbearing capacity, integrity and insulation in accordance with the criteria of BS 476: Part 21: 1987.

1. Promat SUPALUX® boards, 9mm thick.
2. T & G or square-edged flooring, minimum 19mm thick. Secure 4.8mm hardboard over square-edged floorboards.
3. Steel angle, 30mm x 30mm x 0.8mm fastened to sides of joists with M4 x 32mm long steel woodscrews at 300mm nominal centres.
4. Rock wool is required within the cavity, tightly wrapped to sides of joists. Thickness and density of rock wool depends on floor specification. Minimum 50mm thick x 60kg/m³.
5. Timber joists are of such dimensions that the residual timber at the end of the 60 minute fire exposure period will be sufficient to maintain the loadbearing capacity in accordance with Eurocode 5.

Certifire Approval No CF 420

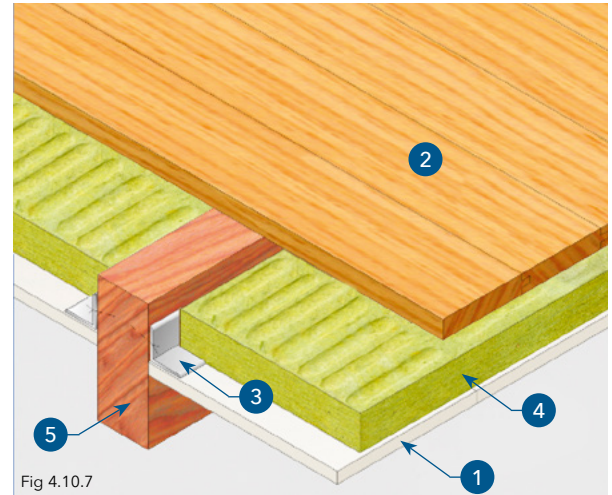

Certifire Approval No CF 420

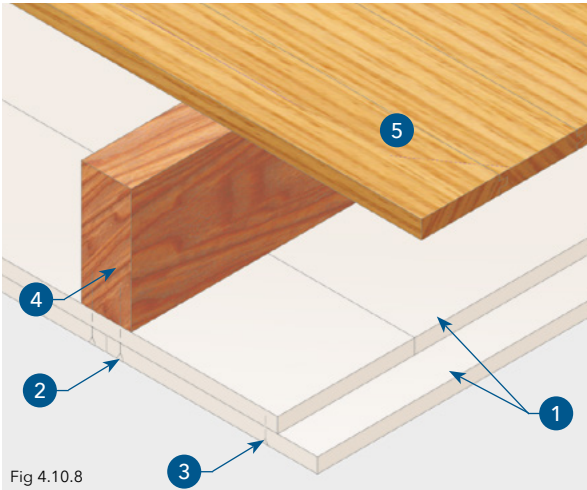

Fig 4.10.8

NEW CEILING LINING

TECHNICAL DATA

90 minutes fire rating, loadbearing capacity, integrity and insulation in accordance with the criteria of BS 476: Part 21: 1987.

1. Promat SUPALUX® boards, 12mm thick. Stagger joints by at least 300mm.

Fixings	Layer 1	Layer 2
	63mm steel wire nails at 400mm centres	M4 x 75mm long steel screws at 300mm centres

3. Fix layer 2 to layer 1 at joints using M4 x 38mm long screws at 300mm centres on both sides of each joint.
4. Timber joists, minimum 200mm x 50mm at maximum 610mm centres.
5. T & G or square-edged flooring, minimum 19mm thick.
6. Secure 4.8mm hardboard over square-edged floorboards.

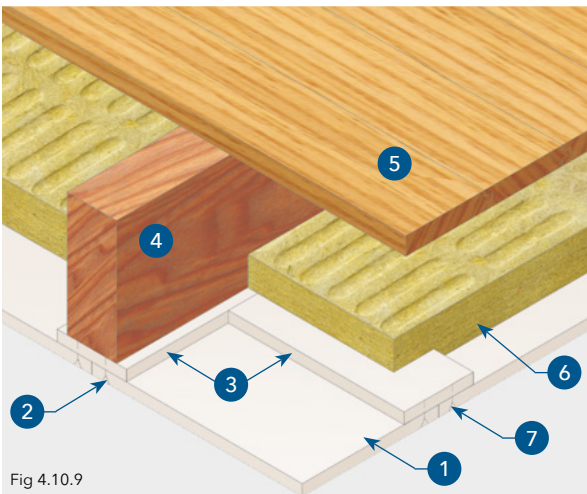

Fig 4.10.9

TECHNICAL DATA

90 minutes fire rating, loadbearing capacity, integrity and insulation in accordance with the criteria of BS 476: Part 21: 1987.

1. Promat SUPALUX® boards, 15mm thick.

Fixings	Fillets	Layer 2
	Tacked to joists with wire nails at any convenient centres	M4 x 75mm long steel screws at 300mm centres

3. Promat SUPALUX® fillet/coverstrip, 80mm wide x 15mm.
4. Timber joists, minimum 220mm x 45mm at maximum 610mm centres.
5. T & G or square-edged flooring, minimum 19mm thick. Secure 4.8mm hardboard over square-edged floorboards.
6. Rock wool, minimum 60mm x 45 kg/m³.
7. Coverstrips at lateral board joints should be fastened using M4 x 38mm long self-tapping screws at nominal 300mm centres on both sides of joint.

Timber Floors and Roofs

NEW CEILING LINING

TECHNICAL DATA

120 minutes fire rating, loadbearing capacity, integrity and insulation in accordance with the criteria of BS 476: Part 21: 1987.

1. Promat SUPALUX® boards, 15mm thick. Stagger joints by at least 300mm.

2. Fixings	Layer 1	Layer 2
	63mm steel wire nails at 400mm centres	M5 x 100mm long steel screws at 300mm centres

3. Fix layer 2 to layer 1 at joints using M4 x 38mm long screws at 300mm centres on both sides of each joint.
4. Timber joists, minimum 200mm x 50mm at maximum 610mm centres.
5. T & G or square-edged flooring, minimum 19mm thick. Secure 4.8mm hardboard over square-edged floorboards.

Certifire Approval No CF 420

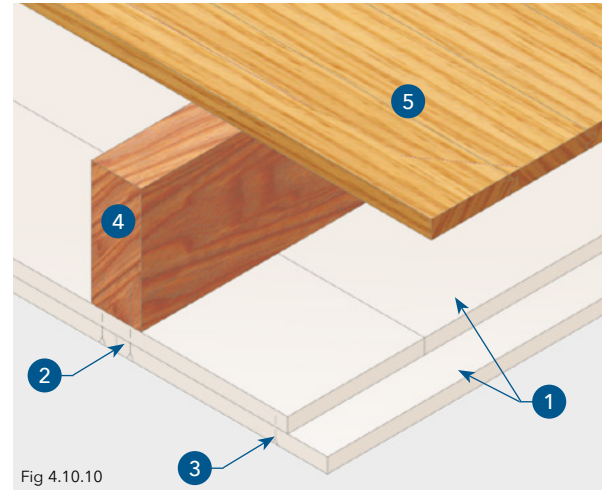

Fig 4.10.10

Notes

A large grid of graph paper for taking notes, consisting of 20 columns and 30 rows of small squares.

FIRE FROM ABOVE AND BELOW

TECHNICAL DATA

60 minutes fire rating, loadbearing capacity, integrity and insulation in accordance with the criteria of BS 476: Part 21: 1987.

1. Promat SUPALUX® boards, 9mm thick. Edges of boards fastened to the flooring with M4 x 30mm long steel woodscrews at 400mm centres.
2. Promat SUPALUX® ceiling (specification select fix) suitable to provide 60 minutes fire protection from below. See Figures 4.10, 4.11 and 4.10.6 for application details.
3. Softwood T & G or square edged flooring, minimum 22mm thick. Secure 4.8mm hardboard over square edged floorboards.
4. Timber joists, minimum 130mm x 38mm at maximum 610mm centres.

Note: Additional flooring material may be required according to the impact and load bearing requirements.

Certifire Approval No CF 420

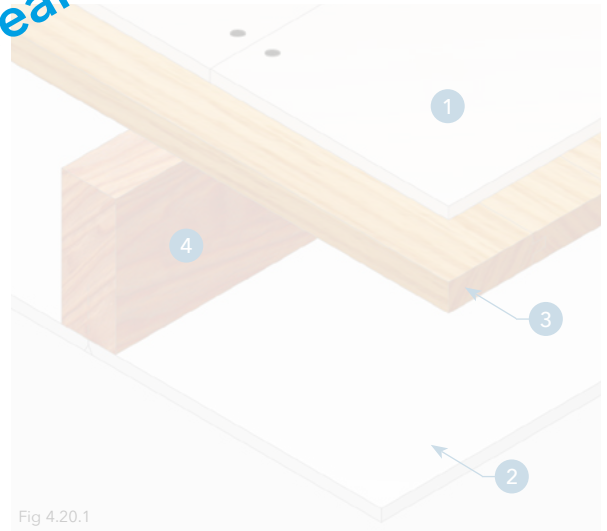

Fig 4.20.1

UPGRADING EXISTING CEILING FROM BELOW

TECHNICAL DATA

60 minutes fire rating, loadbearing capacity, integrity and insulation in accordance with the criteria of BS 476: Part 21: 1987.

1. Promat SUPALUX® boards, 12mm thick.
2. Either 9.5mm gypsum wallboard or lath and plaster. If lath and plaster, it is normally advisable to underline the existing ceiling with chicken wire mesh and timber battens before securing Promat SUPALUX®.
3. M4 woodscrews at 300mm centres to each joist, select screw length to provide at least 50mm penetration into the timber joist.
4. Timber joists, minimum 150mm x 50mm at maximum 610mm centres.
5. T & G or square-edged flooring, minimum 22mm thick. Secure 4.8mm hardboard over square-edged floorboards.

Certifire Approval No CF 420

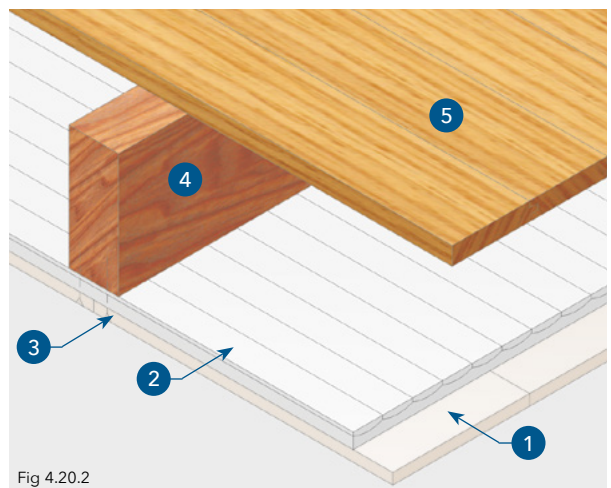

Fig 4.20.2

Certifire Approval No CF 420

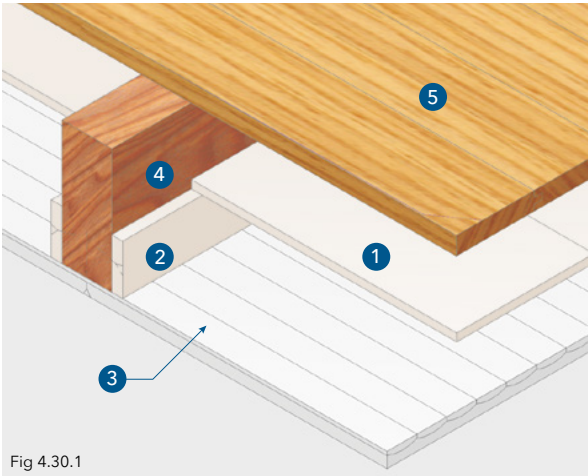

Fig 4.30.1

UPGRADING EXISTING CEILING FROM ABOVE

TECHNICAL DATA

30 minutes fire rating, loadbearing capacity, integrity and insulation in accordance with the criteria of BS 476: Part 21: 1987.

1. Promat SUPALUX® boards, 6mm thick laid on top of supporting strips between joists.
2. Promat SUPALUX® support strips, minimum 50mm deep, at least 12mm thick (2 x 6mm or 1 x 12mm) secured to sides of joists using M4 x 38mm long steel screws at 300mm centres. The bottom edge of support strips should be in contact with ceiling.
3. Existing ceiling.
4. Timber joists, minimum 150mm x 63mm, at maximum 610mm centres.
5. T & G or square edged flooring, minimum 19mm thick. Secure 4.8mm hardboard over square edged floorboards.

Note: The specification is valid for applications where the fire risk is from below but where it is only possible to carry out work from above the floor.

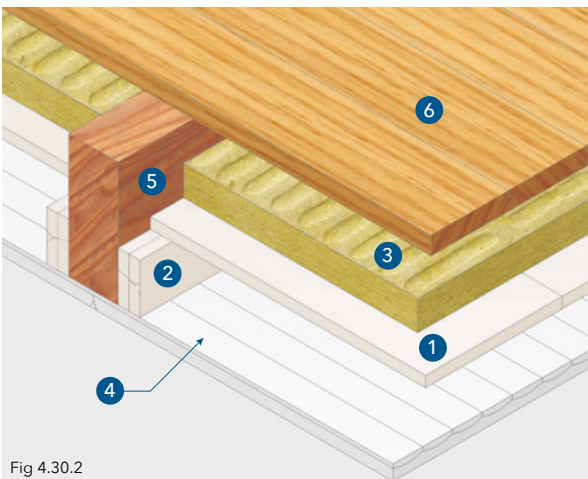

Fig 4.30.2

TECHNICAL DATA

60 minutes fire rating, loadbearing capacity, integrity and insulation in accordance with the criteria of BS 476: Part 21: 1987.

1. Promat SUPALUX® boards, 12mm thick laid on top of supporting strips between joists.
2. 2 x Promat SUPALUX® support strips, each minimum 75mm deep x 12mm thick secured to sides of joists using M4 x 62mm long steel screws at 300mm centres. Ensure screws are located approximately 12mm from upper edge of support strips. The bottom edge of support strips should be in contact with ceiling.
3. Rock wool, minimum 80mm x 23 kg/m³, not required if existing ceiling is gypsum wallboard 12.5mm thick, in good condition.
4. Existing ceiling.
5. Timber joists, minimum 200mm x 75mm, at maximum 450mm centres.
6. T & G or square edged flooring, minimum 19mm thick. Secure 4.8mm hardboard over square edged floorboards.

Note: The specification is valid for applications where the fire risk is from below but where it is only possible to carry out work from above the floor.

TIMBER ROOF VOIDS

TECHNICAL DATA

30 minutes fire rating, load bearing capacity, integrity and insulation in accordance with the criteria of BS 476: Part 21: 1987.

1. Promat SUPALUX® boards 9mm thick.
2. Promat SUPALUX® coverstrip, 80mm wide x 9mm thick.
Cover strips at lateral board joints fastened using M4 x 19mm long steel screws at nominal 300mm centres on both sides of the joint.
3. Rock wool, minimum 130mm thick x 33kg/m³.
4. M4 x 55mm long steel woodscrews at 300mm centres.
5. Timber joists, minimum 97mm deep x 35mm wide at maximum 610mm centres.

Note: For 72mm deep joists, an 80mm wide x 9mm thick Promat SUPALUX® fillet is required to the underside of the joists.

Certifire Approval No CF 420

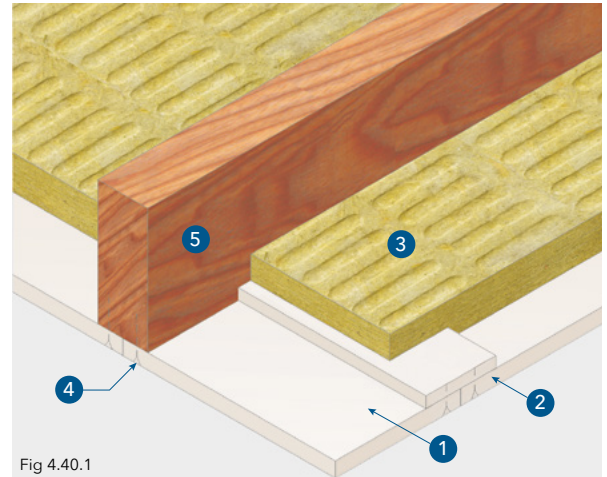

Fig 4.40.1

TECHNICAL DATA

60 minutes fire rating, load bearing capacity, integrity and insulation in accordance with the criteria of BS 476: Part 21: 1987.

1. Promat SUPALUX® boards, 12mm thick.
2. Promat SUPALUX® fillet/coverstrip, 80mm wide x 12mm thick.
Cover strips at lateral board joints fastened using M4 x 25mm long self-tapping screws at nominal 300mm centres on both sides of the joint.
3. Rock wool, minimum 2 x 60mm thick x 100kg/m³, joints staggered by minimum of 150mm between layers.
4. M4 x 75mm long steel woodscrews at 300mm centres.
5. Timber joists, minimum 145mm deep x 35mm wide at maximum 610mm centres.

Note: For 72mm, 97mm and 120mm deep joists, 2 x 80mm wide x 12mm thick Promat SUPALUX® fillets are required to the underside of the joists.

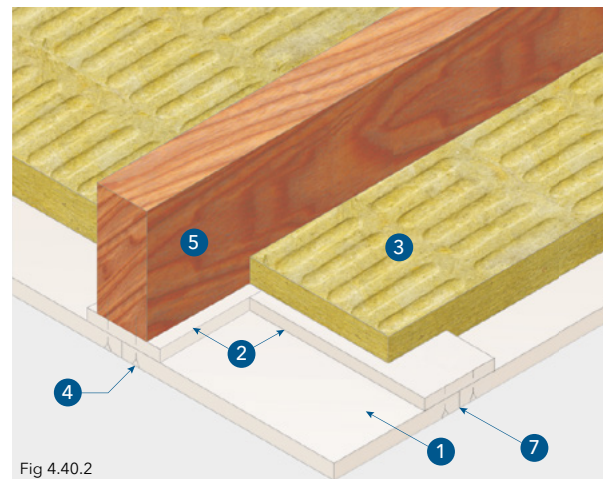
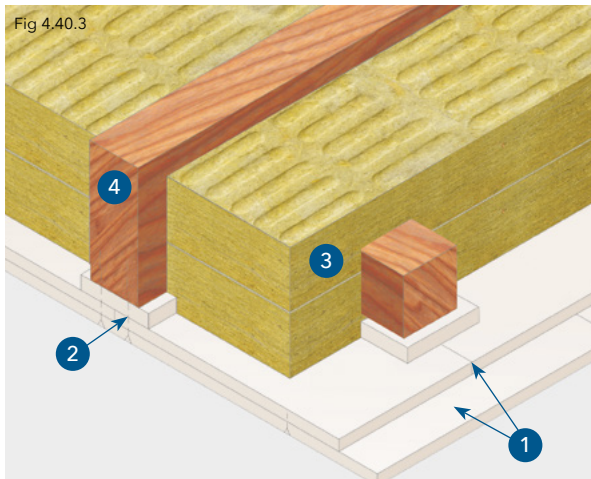

Fig 4.40.2

Certifire Approval No CF 420



TIMBER ROOF VOIDS

TECHNICAL DATA

120 minutes fire rating, load bearing capacity, integrity and insulation in accordance with the criteria of BS 476: Part 21: 1987.

1. Promat SUPALUX® boards, 12mm thick. First layer fixed using 63mm flat head nails at 400mm centres. Second layer, all joints offset by at least 300mm fixed through into the timber joists with M5 x 120mm long steel woodscrews at 300mm centres. Longitudinal board joints in the first layer coincide with the joists. Joints in second layer fixed to first layer with M4 x 25mm long steel woodscrews at 300mm centres on both sides of joint. Joints transverse to joists are also staggered between Promat SUPALUX® layers, cross noggings are required at transverse joints.
2. Promat SUPALUX® fillet, 100mm wide x 12mm thick.
3. Rock wool, minimum 2 x 100mm thick x 30kg/m³, joints staggered by minimum of 150mm between layers.
4. Timber joists, minimum 145mm deep x 50mm wide at maximum 610mm centres.

THATCHED ROOFS

Promat can offer a series of systems based around the 'Dorset Model'. These systems can offer up to 60 minutes fire protection to thatched roofs. For more information on these systems, please contact the Promat Technical Services.

Mezzanine Floors

30 AND 60 MINUTE PROMATECT®-250 STEEL JOISTED MEZZANINE FLOOR

SUPPORTING STEEL FRAME

The supporting steel framework of the mezzanine floor (1) (including the columns) should be fire protected for a period equal to, or greater than that required for the mezzanine floor itself. This may normally be achieved using 15mm PROMATECT®-250 for section factors of up to 135m^{-1} for 60 minutes, or for section factors of up to 350m^{-1} for 30 minutes. For further details on the requirements for protecting structural steelwork, refer to the Promat Fire Protection Handbook, Chapter 3.

COLD ROLLED JOISTS

Galvanised steel channel joists designed in accordance with BS 5950-5 (4) at maximum 600mm centres. Joists minimum 172mm deep may be used depending upon the spanning and loading requirements. The maximum floor loading should not exceed 80% of the maximum design load calculated from the joist manufacturers loading tables for the chosen joist size.

Joists may be inset cleated (6) to the supporting beams (as shown) to maximise headroom, or designed with top cleats where the joists oversail the beams, using cleats of minimum 3mm thickness and fastened with minimum two M12 bolts. The lower web of each pair of joists (8) is connected at mid-span by a steel threaded rod tie bar, nuts and washers. These are typically M12.

FLOORING

38mm thick x 600mm wide Flooring Grade P6 Chipboard to BS EN 312:1997, T&G on two long edges (2), designed to BS 6399-1:1996 for loadings up to 5.0kN/m^2 UDL; laid perpendicular to the joists and fixed using 60mm Timberdeck winged self-drilling screws (3) at 300mm centres (2 fixings per board at each joist position). Board joints to coincide with joists, and staggered between panels.

CEILING

15mm thick x 2500mm x 1200mm PROMATECT®-250 boards (5), fastened parallel to the joists (with staggered transverse joints) using 32mm self-drilling drywall screws (7), at nominal 200mm centres.

BACKING STRIPS

15mm thick x 100mm wide PROMATECT®-250 cover strips (9) are placed over the transverse joints between the joists, tightly wedged into position (fixings not essential).

NB: Consult mezzanine joist manufacturers for joist sizes and centres, appropriate to the loading requirements of the mezzanine floor.

Bodycote: WF Assessment No 162600

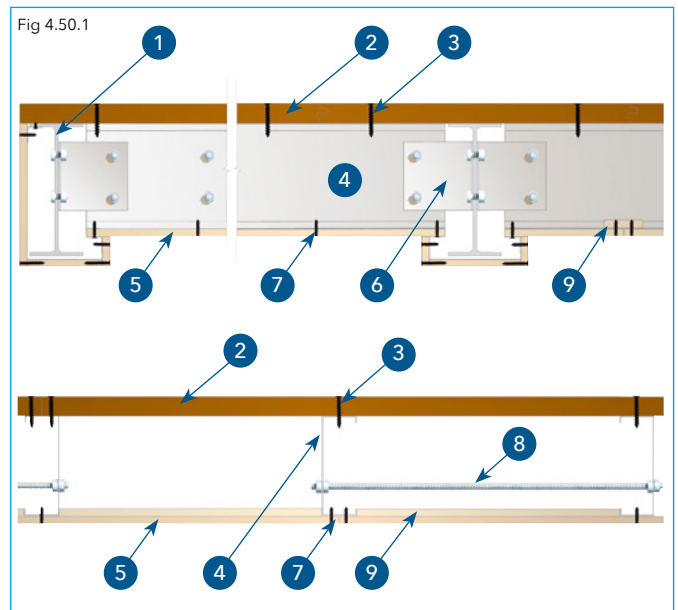

Bodycote: WF Assessment No 162600

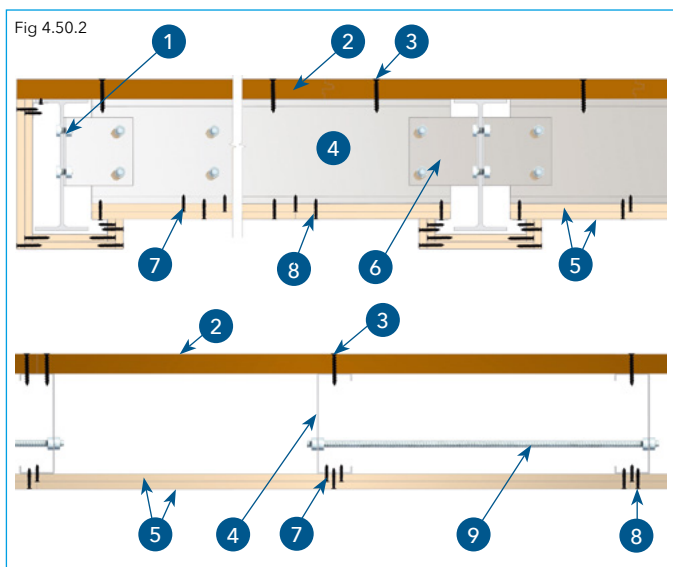

90 AND 120 MINUTE PROMATECT®-250 STEEL JOISTED MEZZANINE FLOOR

SUPPORTING STEEL FRAME

The supporting steel framework of the mezzanine floor (1) (including the columns) should be fire protected for a period equal to, or greater than that required for the mezzanine floor itself. This may normally be achieved using 2 x 15mm PROMATECT®-250 for section factors of up to 140m⁻¹ for 120 minutes, or section factors of up to 350m⁻¹ for 90 minutes. For further details on the requirements for protecting structural steelwork, refer to the Promat Fire Protection Handbook, Chapter 3.

COLD ROLLED JOISTS

Galvanised steel channel joists designed in accordance with BS 5950-5 (4) at maximum 600mm centres. Joists down to 172mm deep may be used depending upon the spanning and loading requirements. The maximum floor loading should not exceed 80% of the maximum design load calculated from the joist manufacturers loading labels for the chosen joist size.

Joists may be inset cleated (6) to the supporting beams (as shown) to maximise headroom, or designed with top cleats where the joists oversail the beams, using cleats of minimum 3mm thickness and fastened with minimum two M12 bolts. The lower web of each pair of joists (9) is connected at mid-span by a steel threaded rod tie bar, nuts and washers. These are typically M12.

FLOORING

38mm thick x 600mm wide Flooring Grade P6 Chipboard to BS EN 312:1997, T&G on two long edges (2), designed to BS 6399-1:1996 for loadings up to 5.0kN/m² UDL; laid perpendicular to the joists and fastened using 60mm Timberdeck winged self-drilling screws (3) at 300mm centres (2 fixings per board at each joist position). Board joints to coincide with joists, and staggered between panels.

CEILING

Two layers of 15mm thick x 2500mm x 1200mm PROMATECT®-250 boards (5), are fastened to the underside of the steel joists. Boards are laid parallel to the joists with joints coincident with the joists, and are staggered by at least 600mm between layers. Transverse board joints are staggered by at least 300mm between layers and fastened using minimum 32mm (first layer) (7), and 41mm (second layer) (8), using self-drilling drywall screws at nominal 200mm centres in both layers. Cover strips to transverse joints are not required.

NB: Consult mezzanine joist manufacturers for joist sizes and centres, appropriate to the loading requirements of the mezzanine floor.

Protection to Concrete Floor Slabs

CONCRETE FLOORS

Fire Testing Methods

Concrete floors should normally be tested or assessed in accordance with BS 476: Part 21: 1987, or BS EN 13381-3, and are required to satisfy the three failure criteria of loadbearing capacity, integrity and insulation when exposed to fire from below. Floors protected with a suspended ceiling should be tested or assessed to BS 476: Part 23: 1987. The systems detailed in this section satisfy the above requirements. Please contact the Promat Technical Services Department for further details.

PROTECTION TO REINFORCED CONCRETE FLOOR

Promat have a range of boarded and spray applied solutions that can be applied directly to the underside of the concrete floor slabs, to provide fire protection in this application.

Please contact the Technical Services Department for more information.

DESIGN CONSIDERATIONS

The following points should be considered when determining the correct specification to ensure a concrete floor will provide the required fire performance:

Concrete Density

Density not only affects the concrete's strength but also its insulation properties and susceptibility to spalling when exposed to fire.

Concrete Moisture Content

Depending on the concrete type, concrete can spall when exposed to fire if its moisture content is greater than 2-3%.

Concrete Thickness and Cover to Reinforcing Bars

The overall slab thickness will contribute to the strength and insulation of the structure, but the concrete cover to the lowest reinforcing bars is also critical. The concrete slab may need upgrading if inadequate cover has been provided.

Supporting Steelwork

Care should be taken that any structural steel supporting the concrete slab is adequately protected against fire.

Other Factors

The references made in the timber floor section to suspended ceilings, light fittings, service penetrations, cavity barriers and loading apply equally well to concrete floors.

Type of Fire Exposure

Building Regulations lay down limitations on the use of fire protecting suspended ceilings in certain situations. Care should be taken to ensure that the use of a suspended ceiling system is acceptable to the approval authorities.

Concealed Grid Suspended and Membrane Ceilings

For each primary channel a provision for longitudinal expansion equivalent to 20mm for each 3m length should be made. A nominal expansion clearance of 3mm is left between each end of each cross channel and the adjoining primary channel.

Chapter 4: Ceilings, Floors and Roofs
Suspended Ceilings

Certifire Approval No CF 420

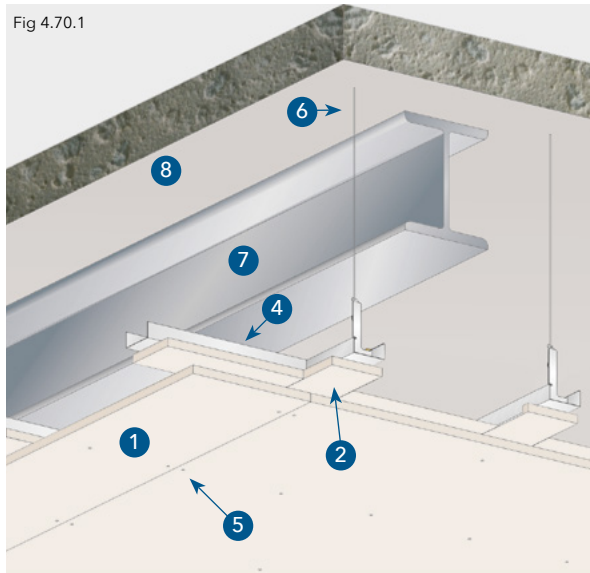

PROTECTION TO STEEL BEAMS CONCEALED GRID

TECHNICAL DATA

Protection to steel beams supporting concrete floor - 60 minutes fire rating, loadbearing capacity (for steel beams above) in accordance with the criteria of BS 476: Part 23: 1987

1. Promat SUPALUX® boards, 9mm thick (square or bevelled edge).
2. Promat SUPALUX® fillet, 75mm wide, 9mm thick.
3. No rock wool required.
4. Fire rated ceiling channel section, minimum 60mm x 27mm x 0.5mm at 600mm or 610mm centres (primary channels are lipped).
5. Fillets fixed to underside of primary and cross channels and perimeter angle using M4 x 25mm long steel self-tapping screws at any convenient centres. Promat SUPALUX® boards fixed through fillets to channels and perimeter angle with M4 x 25mm long steel self-tapping screws at nominal 300mm centres.
6. Rigid hangers at 1000mm centres (fixed to steel beam or concrete soffit).
7. Structural steel beam.
8. Concrete floor slab.

Perimeter steel angles 50mm x 50mm x 0.7mm thick are fastened at nominal 400mm centres to the concrete or masonry surrounding structure using minimum M4 x 32mm long steel screws into non-combustible plugs or equivalent.

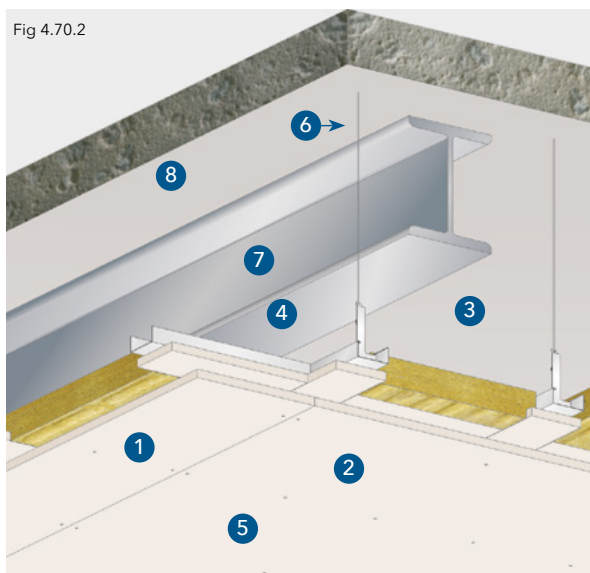

TECHNICAL DATA

Protection to steel beams supporting concrete floor - 90 minutes fire rating, loadbearing capacity (for steel beams above) in accordance with the criteria of BS 476: Part 23: 1987

1. Promat SUPALUX® boards, 9mm thick (square or bevelled edge).
2. Promat SUPALUX® fillet, 75mm wide, 9mm thick.
3. Rock wool, minimum 40mm thick x 33kg/m³ or 30mm thick x 45kg/m³ density.
4. Fire rated ceiling channel section, minimum 60mm x 27mm x 0.5mm at 600mm or 610mm centres (primary channels are lipped).
5. Fillets fixed to underside of primary and cross channels and perimeter angle using M4 x 25mm long steel self-tapping screws at any convenient centres. Promat SUPALUX® boards fixed through fillets to channels and perimeter angle with M4 x 25mm long steel self-tapping screws at nominal 300mm centres.
6. Rigid hangers at 1000mm centres (fixed to steel beam or concrete soffit).
7. Structural steel beam.
8. Concrete floor slab.

Perimeter steel angles 50mm x 50mm x 0.7mm thick are fastened at nominal 400mm centres to the concrete or masonry surrounding structure using minimum M4 x 32mm long steel screws into non-combustible plugs or equivalent.

Suspended Ceilings

PROTECTION TO STEEL BEAMS CONCEALED GRID

TECHNICAL DATA

Protection to steel beams supporting concrete floor - 120 minutes fire rating, loadbearing capacity (for steel beams above) in accordance with the criteria of BS 476: Part 23: 1987

1. Promat SUPALUX® boards, 9mm thick (square or bevelled edge).
2. Promat SUPALUX® fillet 75mm wide, 9mm thick.
3. Rock wool, minimum 40mm thick x 60kg/m³ or 30mm thick x 80kg/m³ density.
4. Fire rated ceiling channel section, minimum 60mm x 27mm x 0.5mm at 600mm or 610mm centres (primary channels are lipped).
5. Fillets fixed to underside of primary and cross channels and perimeter angle using M4 x 25mm long steel self-tapping screws at any convenient centres. Promat SUPALUX® boards fixed through fillets to channels and perimeter angle with M4 x 25mm long steel self-tapping screws at nominal 300mm centres.
6. Rigid hangers at 1000mm centres (fixed to steel beam or concrete soffit).
7. Structural steel beam.
8. Concrete floor slab.

Perimeter steel angles 50mm x 50mm x 0.7mm thick are fastened at nominal 400mm centres to the concrete or masonry surrounding structure using minimum M4 x 32mm long steel screws into non-combustible plugs or equivalent.

Certifire Approval No CF 420

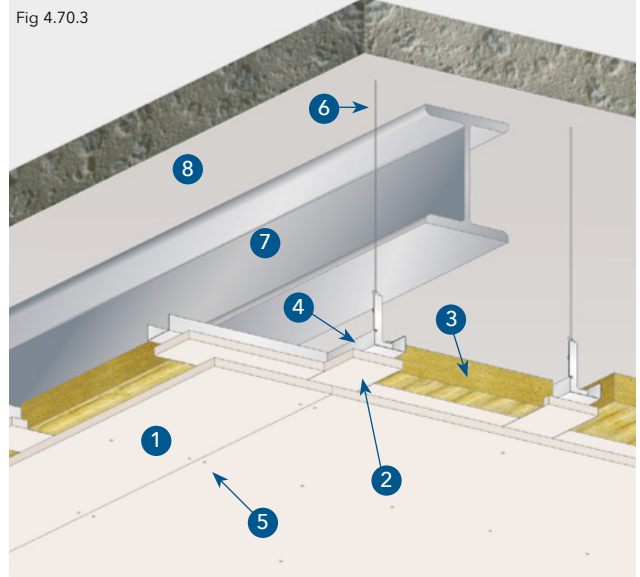

Certifire Approval No CF 420

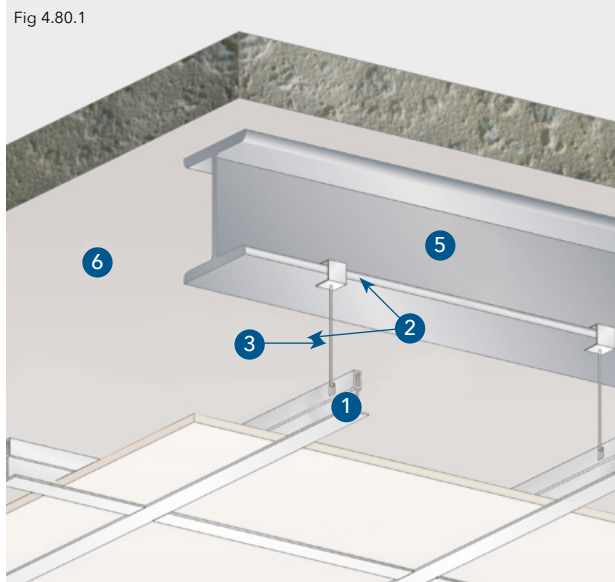

PROTECTION TO STEEL BEAMS EXPOSED GRID

TECHNICAL DATA

Protection to steel beams supporting concrete floor - 30 minutes fire rating, loadbearing capacity (for steel beams above) in accordance with the criteria of BS 476: Part 23: 1987.

1. Promat SUPALUX® ceiling panels, 6mm thick by 1200mm x 600mm or 600mm x 600mm nominal, located at least 200mm from underside of steel beam.
2. Fire rated exposed grid tee system (minimum table width of 24mm) main tees at 1200mm or 600mm centres. Panels are fixed using steel hold down clips - 3 along each 1200mm edge and one at the centre of a 600mm edge. Perimeter steel angles with minimum 32mm wide horizontal leg and 19mm wide vertical leg and between 0.5 and 0.8mm thick, should be fastened using M4 x 32mm long steel self-tapping screws into non-combustible plugs or equivalent at nominal 400mm centres to the concrete or masonry surrounding structure.
3. Galvanised steel wire hangers (minimum 2mm diameter) at maximum 1220mm centres, fixed to beams using steel flange clips. Alternatively fixed to concrete slab using suitable fire-rated all-steel ring or hook anchors, minimum 5mm diameter.
4. Rock wool not required for 30 minutes fire resistance but may be required for thermal or acoustic reasons.
5. Structural steel beam.
6. Concrete floor slab.

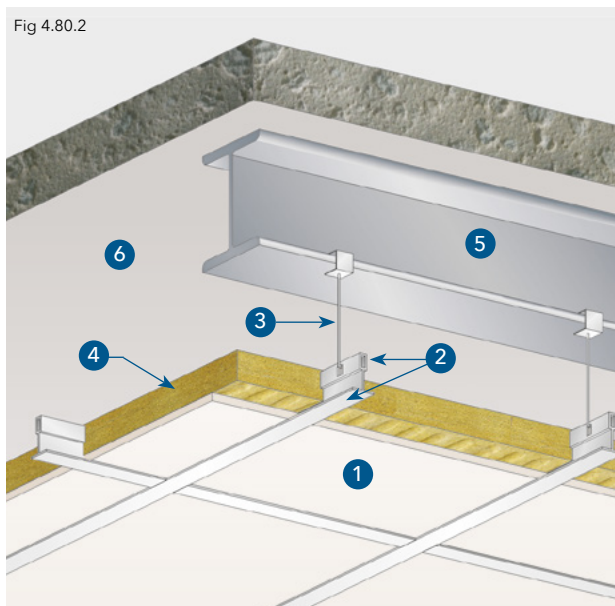

TECHNICAL DATA

Protection to steel beams supporting concrete floor - 60 minutes fire rating, loadbearing capacity (for steel beams above) in accordance with the criteria of BS 476: Part 23: 1987.

1. Promat SUPALUX® ceiling panels, 6mm thick by 1200mm x 600mm or 600mm x 600mm nominal, located at least 200mm from underside of steel beam.
2. Fire rated exposed grid tee system (minimum table width of 24mm) main tees at 1200mm or 600mm centres. Panels are fixed using steel hold down clips - 3 along each 1200mm edge and one at the centre of a 600mm edge. Perimeter steel angles with minimum 32mm wide horizontal leg and 19mm wide vertical leg and between 0.5 and 0.8mm thick, should be fastened using M4 x 32mm long steel self-tapping screws into non-combustible plugs or equivalent at nominal 400mm centres to the concrete or masonry surrounding structure.
3. Galvanised steel wire hangers (minimum 2mm diameter) at maximum 1220mm centres, fixed to beams using steel flange clips. Alternatively fixed to concrete slab using suitable fire-rated all-steel ring or hook anchors, minimum 5mm diameter.
4. Rock wool minimum 30mm x 60kg/m³ density.
5. Structural steel beam.
6. Concrete floor slab.

Suspended Ceilings

MEMBRANE CEILING

TECHNICAL DATA

60 minutes fire rating, integrity and insulation in accordance with the criteria of BS 476: Part 22: 1987 with fire from above or below.

1. Promat SUPALUX® boards, 9mm thick (square or bevelled edge).
2. Promat SUPALUX® fillet, 75mm wide, 9mm thick.
3. Two layers of rock wool, each a minimum 50mm x 60kg/m³ or 60mm x 45kg/m³. Joints should be staggered 300mm between layers.
4. Perimeter steel angles minimum 50mm x 50mm x 0.7mm thick fastened using M4 x 32mm long steel self-tapping screws into non-combustible plugs or equivalent at nominal 400mm centres to the concrete or masonry surrounding structure.
5. Fire rated concealed channel system ceiling channel section minimum 60mm wide x 27mm deep x 0.5mm steel thickness. Primary channels are lipped channels. Primary channels positioned at nominal 600mm centres. Cross channels positioned between primary channels at board joints and connected to primary channels using interlocking steel connectors.
6. Fillet fixed to underside of primary and cross channels and perimeter angle with M4 x 25mm long steel self-tapping screws with M4 x 25mm long steel self-tapping screws at any convenient centres. Promat SUPALUX® boards fixed through fillets to channels and perimeter angle with M4 x 32mm long steel self-tapping screws at nominal 300mm centres.
7. Hanger rod at 1000mm centres, tensile stress on hanger should not exceed 15N/mm² (for fire exposure from above). Please consult Promat Technical Services Department for details of fixing hanger rods to structural soffit.

Note: Maximum panel size for square edge: 2440mm x 1220mm
Maximum panel size for bevel edge: 1220mm x 1220mm

Certifire Approval No CF 420

Fig 4.90.1

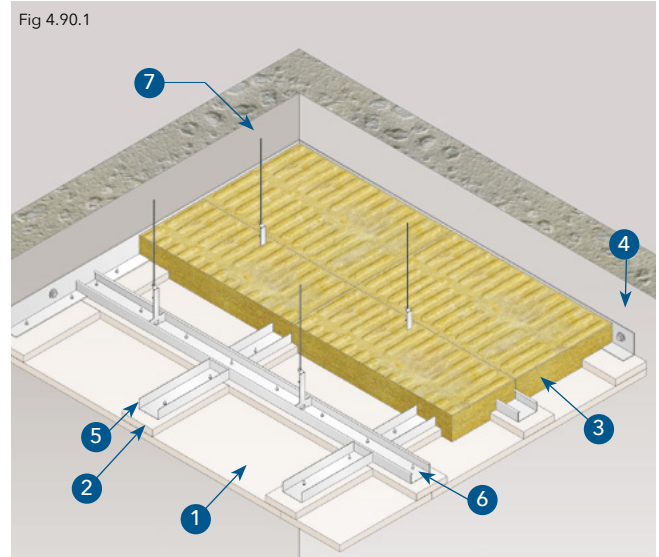

Certifire Approval No CF 420

Fig 4.90.2

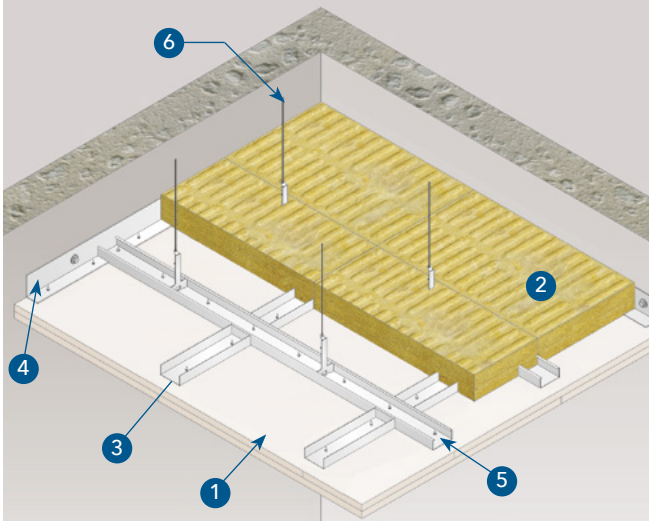

MEMBRANE CEILING

TECHNICAL DATA

120 minutes fire rating, integrity and insulation in accordance with the criteria of BS 476: Part 22: 1987 with fire from above or below.

1. Promat SUPALUX® boards (square edged), 2 layers of 9mm thick. Joints staggered by nominal 300mm between layers.
2. Rock wool, minimum 100mm thick (2 x 50mm) x 100kg/m³ (Joints should be staggered 300mm between layers).
3. Fire rated concealed channel system. Ceiling channel section, minimum 60mm x 27mm x 0.5mm steel thickness Primary channels are lipped channels. Primary channels positioned at maximum 610mm centres. Cross channels positioned between primary channels at board joints and connected to primary channels using interlocking steel connectors.
4. Perimeter steel angles minimum 50mm x 50mm x 0.7mm thick fastened at nominal 400mm centres using M4 x 32mm long steel self-tapping screws into non-combustible plugs or equivalent to the concrete or masonry surrounding structure.
5. First layer fixed with M4 x 25mm self-tapping screws at nominal 300mm centres. Second layer fixed with M4 x 32mm long steel self-tapping screws at nominal 300mm centres. (Joints should be staggered between layers).
6. Hanger rod at maximum 1000mm centres, tensile stress on hanger should not exceed 10N/mm² (for fire exposure from above the ceiling).

Fig 4.90.3

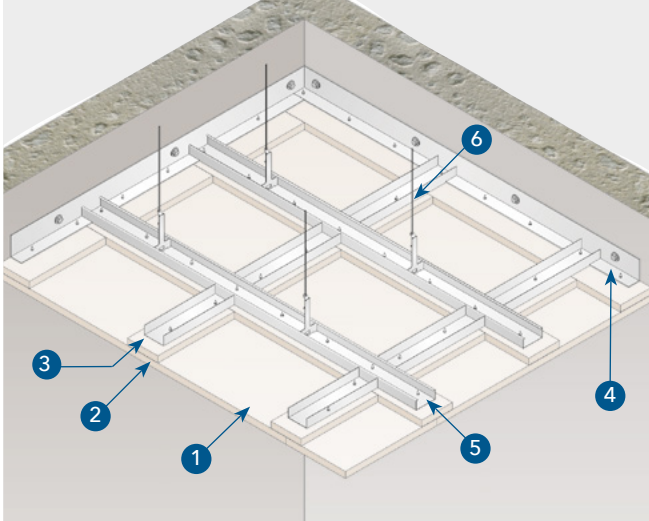

TECHNICAL DATA

240 minutes fire rating, integrity in accordance with the criteria of BS 476: Part 22: 1987 with fire from below.

1. Promat SUPALUX® boards (square edged) 9mm thick.
2. Promat SUPALUX® fillet, 75mm wide x 9mm thick.
3. Fire rated concealed channel system. Ceiling channel section minimum 60mm wide x 27mm deep x 0.5mm steel thickness. Primary channels are lipped channels. Primary channels positioned at maximum 610mm centres. Cross channels positioned between primary channels at board joints and connected to primary channels using interlocking steel connectors.
4. Perimeter steel angles minimum 50mm x 50mm x 0.7mm thick fastened at nominal 400mm centres using M4 x 32mm long steel self-tapping screws into non-combustible plugs or equivalent to the concrete or masonry surrounding structure.
5. Fillet fixed to underside of primary and cross channels and perimeter angle with M4 x 25mm long steel self-tapping screws at convenient centres. Promat SUPALUX® board fixed through fillets to channels and perimeter angles with M4 x 32mm long steel self-tapping screws at nominal 300mm centres.
6. Hanger rod at maximum 1220mm centres.

Suspended Ceilings

TIMBER FLOORS

The provisions of the Building Regulations lay down limitations on the use of fire protecting suspended ceilings in certain situations. Care should be taken to ensure that the use of a suspended ceiling system is acceptable to the approval authorities. As Promat SUPALUX® ceiling panels are non-combustible, Class 0 materials, the following systems should be acceptable providing the Building Regulations guidance on cavity barriers and access panels are followed.

TECHNICAL DATA

Exposed Grid System

30 minutes fire rating, loadbearing capacity, integrity and insulation in accordance with the criteria of BS 476: Part 21: 1987.

1. Promat SUPALUX® ceiling panels, 6mm thick by 1200mm x 600mm or 600mm x 600mm nominal, located at least 200mm from underside of joists.
2. Fire rated exposed grid tee system (minimum table width 24mm), main tees at maximum 610mm centres. Panels are fixed using steel hold down clips - 3 along each 1200mm edge and one at the centre of a 600mm edge. Perimeter steel angles with minimum 32mm wide horizontal leg and 19mm wide vertical leg and between 0.5 and 0.8mm thick, fastened at nominal 400mm centres to the concrete or masonry surrounding structure.
3. Galvanised wire hangers, minimum 2mm diameter at maximum 1220mm centres. Secure hangers to sides of joists using 38mm nails or screws located at least 75mm above joist base.
4. Timber joists, minimum 150mm x 38mm at maximum 610mm centres.
5. T & G or square-edged flooring, minimum 19mm thick. Secure 4.8mm hardboard over square-edged floorboards.

Certifire Approval No CF 420

Fig 4.100.1

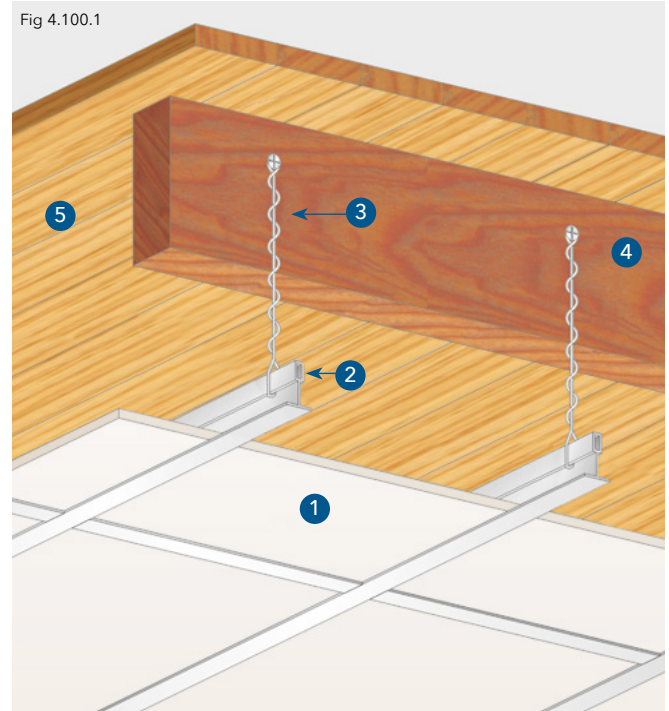

Certifire Approval No CF 420

Fig 4.100.2

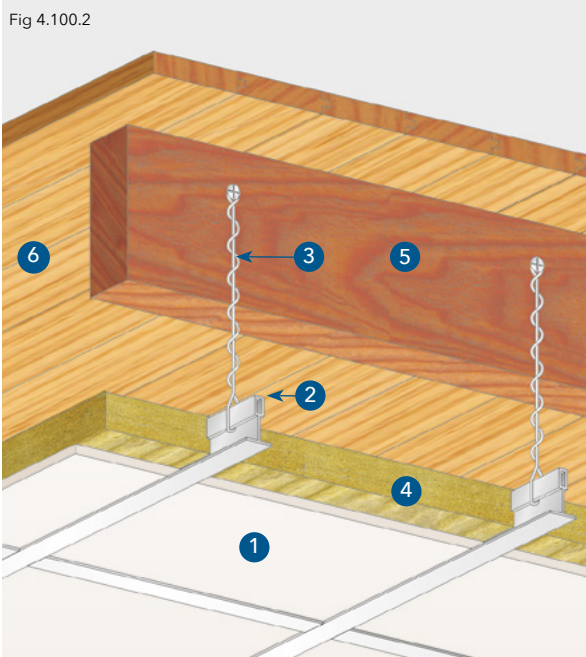

TIMBER FLOORS

TECHNICAL DATA

Exposed Grid System

60 minutes fire rating, loadbearing capacity, integrity and insulation in accordance with the criteria of BS 476: Part 21: 1987.

1. Promat SUPALUX® ceiling panels, 6mm thick by 1200mm x 600mm or 600mm x 600mm nominal, located at least 200mm from underside of joists.
2. Fire rated exposed grid tee system (minimum table width 24mm), main tees at maximum 610mm centres. Panels are fixed using steel hold down clips - 3 along each 1200mm edge and one at the centre of a 600mm edge. Perimeter steel angles with minimum 32mm wide horizontal leg and 19mm wide vertical leg and between 0.5 and 0.8mm thick, fastened at nominal 400mm centres to the concrete or masonry surrounding structure with minimum M4 x 32mm fixings.
3. Galvanised wire hangers, minimum 2mm diameter at maximum 1220mm centres. Secure hangers to sides of joists using 38mm nails or screws located at least 75mm above joist base.
4. Rock wool, minimum 30mm x 60 kg/m³ fitted between tees.
5. Timber joists, minimum 150mm x 38mm at maximum 610mm centres.
6. T & G or square-edged flooring, minimum 19mm. Secure 4.8mm hardboard over square-edged floorboards.

TIMBER FLOORS

TECHNICAL DATA

Concealed Grid System

60 minutes fire rating, loadbearing capacity, integrity and insulation in accordance with the criteria of BS 476: Part 21: 1987.

1. Promat SUPALUX® 12mm panels (square or bevelled edge) to be located at least 200mm below underside of timber joists.
2. Promat SUPALUX® fillet, 75mm wide x 12mm thick.
3. Fillets fixed to underside of primary and cross channels and perimeter angle with M4 x 25mm long steel self-tapping screws at any convenient centres. Promat SUPALUX® boards fixed through fillets to channels and perimeter angles with M4 x 32mm long steel self-tapping screws at nominal 300mm centres.
4. Fire rated concealed channel system. Ceiling channel section minimum 60mm wide x 27mm deep x 0.5mm steel thickness. Primary channels are lipped channels. Primary channels positioned at maximum 610mm centres. Cross channels positioned between primary channels at board joints and connected to primary channels using interlocking steel connectors. Perimeter steel angles minimum 50mm x 50mm x 0.7mm thick fastened at nominal 400mm centres to the concrete or masonry surrounding structure with minimum M4 x 32mm long steel screws into non-combustible plugs or equivalent.
5. Rigid hangers at maximum 1220mm centres secured to sides of joists using 38mm nails or screws located at least 75mm above joist base.
6. Rock wool, minimum 50mm x 45 kg/m³ laid over panels and grid members.
7. Timber joists, minimum 150mm x 38mm at maximum 610mm centres.
8. T & G or square-edged flooring, minimum 19mm. Secure 4.8mm hardboard over square-edged floorboards.

Note: Maximum panel size for square edge: 2440mm x 1220mm

Maximum panel size for bevel edge: 1220mm x 1220mm

Certifire Approval No CF 420

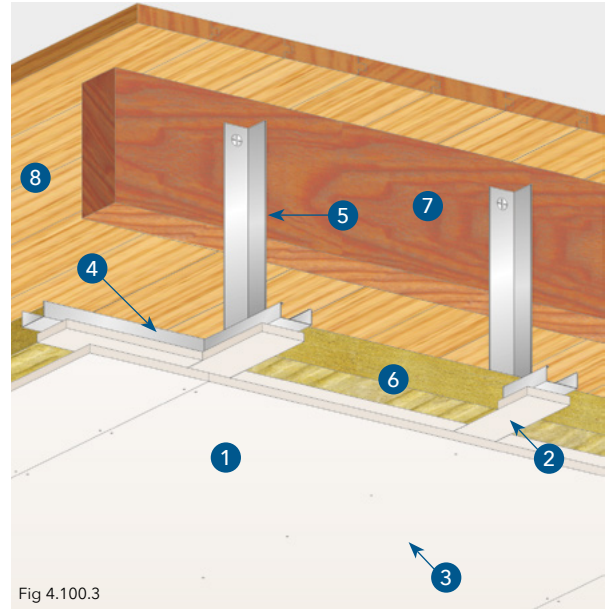

Self-Supporting Ceiling Membranes

Certifire Approval No CF 420

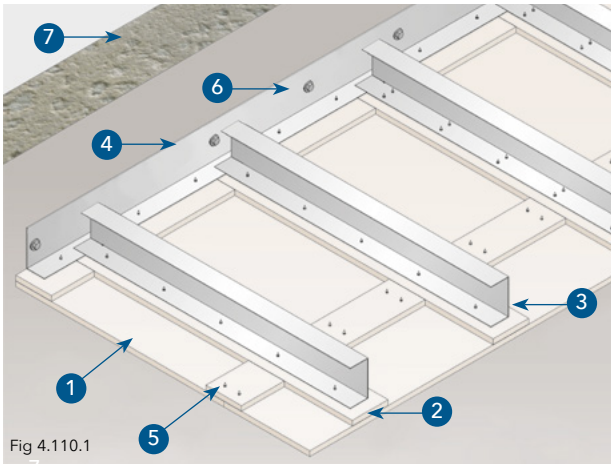

Fig 4.110.1

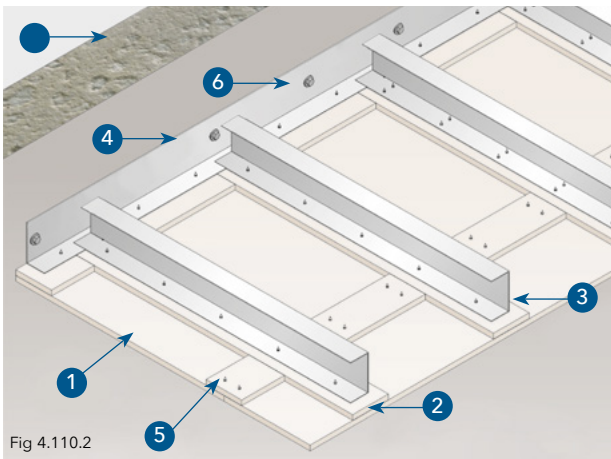

Fig 4.110.2

Table 4a 60 and 120 minutes

Ceiling span (m)	C Channel purlin (mm)	Perimeter angle thickness (mm)	Expansion gap at each end (mm)
1.2	76 x 34 x 0.55	1.0	8
1.4	92 x 34 x 0.55	1.0	8
1.6	92 x 34 x 0.75	1.0	12
1.8	100 x 44 x 1.0	2.0	12
2.0	100 x 44 x 1.0	2.0	12
2.2	100 x 44 x 1.0	2.0	15
2.4	100 x 44 x 1.2	2.0	15
2.6	100 x 44 x 1.6	2.0	15
2.8	100 x 44 x 1.9	2.0	18
3.0	150 x 44 x 1.2	2.0	18
3.2	150 x 44 x 1.2	3.0	18
3.4	150 x 44 x 1.6	3.0	23
3.6	150 x 44 x 1.6	3.0	23
3.8	150 x 44 x 1.9	3.0	23
4.0	150 x 44 x 1.9	3.0	23

SELF-SUPPORTING CEILING MEMBRANES

TECHNICAL DATA

60 minutes fire rating, integrity only; in accordance with the criteria of BS 476: Part 22: 1987 with fire from below.

- Promat SUPALUX® boards, 9mm thick (square edged).
- Promat SUPALUX® fillets, 75mm x 9mm thick. The thickness of Promat SUPALUX® fillets on underside of the perimeter angles may be reduced by 3mm to maintain an even surface for the main ceiling boards.
- C-channel purlins (see table below) positioned at maximum 610mm centres. Expansion gap is left at both ends of the C channels.
- Perimeter steel angle, nominally 75mm x 50mm, fastened to wall around perimeter of ceiling, through the 50mm leg, with minimum M6 x 50mm long all steel fixing anchors at 300mm nominal centres. See table below for angle thickness.
- M4 x 38mm long self-tapping screws fixed at 200mm centres on facing board and M4 x 25mm long self-tapping screws at 500mm centres on fillets to channels and perimeter angles.
- M6 x 50mm long steel expansion bolts at 300mm centres.
- Concrete or brickwall.

120 minutes fire rating, integrity only; in accordance with the criteria of BS 476: Part 22: 1987 with fire from below.

- Promat SUPALUX® boards, 12mm thick (square edged).
- Promat SUPALUX® fillets, 75mm x 12mm thick. The thickness of Promat SUPALUX® fillets on underside of the perimeter angles may be reduced by 3mm to maintain an even surface for the main ceiling boards.
- C-channel purlins (see table below) positioned at maximum 610mm centres. Expansion gap is left at both ends of the C channels.
- Perimeter steel angle, nominally 75mm x 50mm, fastened to wall around perimeter of ceiling, through the 50mm leg, with minimum M6 x 50mm long all steel fixing anchors at 300mm nominal centres. See table below for angle thickness.
- M4 x 38mm long self-tapping screws fixed at 200mm centres on facing board and M4 x 25mm long self-tapping screws at 500mm centres on fillets to channels and perimeter angles.
- M6 x 50mm long steel expansion bolts at 300mm centres.
- Concrete or brickwall.

SELF-SUPPORTING CEILING MEMBRANES

TECHNICAL DATA

60 minutes fire rating, integrity only; in accordance with the criteria of BS 476: Part 22: 1987 with fire from above or below.

1. Promat SUPALUX® boards, 9mm thick (square edged).
2. Promat SUPALUX® fillets, 75mm x 9mm thick. The thickness of Promat SUPALUX® fillets on underside of the perimeter angles may be reduced by 3mm to maintain an even surface for the main ceiling boards. Lateral board joints backed by Promat SUPALUX® fillet fastened using M4 x 25mm long self-tapping screws at nominal 200mm centres on both sides of the joint.
3. C-channel purlins (see table below) positioned at maximum 610mm centres. Expansion gap is left at both ends of the C channels.
4. Perimeter steel angle, nominally 75mm x 50mm, fastened to wall around perimeter of ceiling, through the 50mm leg, with minimum M6 x 50mm long all steel fixing anchors at 300mm nominal centres. See table for angle thickness.
5. M4 x 38mm long self-tapping screws fixed at 200mm centres on facing board and M4 x 25mm self-tapping screws at 500mm centres on fillets to channels and perimeter angles.
6. M6 x 50mm long steel expansion bolts at 300mm centres.
7. Concrete or brickwall.

120 minutes fire rating, integrity only; in accordance with the criteria of BS 476: Part 22: 1987 with fire from above or below.

1. Promat SUPALUX® boards, 12mm thick (square edged).
2. Promat SUPALUX® fillets, 75mm x 12mm thick. The thickness of Promat SUPALUX® fillets on underside of the perimeter angles may be reduced by 3mm to maintain an even surface for the main ceiling boards. Lateral board joints backed by Promat SUPALUX® fillet fastened using M4 x 25mm long self-tapping screws at nominal 200mm centres on both sides of the joint.
3. C-channel purlins (see table below) positioned at maximum 610mm centres. Expansion gap is left at both ends of the C channels.
4. Perimeter steel angle, nominally 75mm x 50mm, fastened to wall around perimeter of ceiling, through the 50mm leg, with minimum M6 x 50mm long all steel fixing anchors at 300mm nominal centres. See table for angle thickness.
5. M4 x 38mm self-tapping screws fixed at 200mm centres on facing board and M4 x 25mm self-tapping screws at 500mm centres on fillets to channels and perimeter angles.
6. M6 x 50mm long steel expansion bolts at 300mm centres.
7. Concrete or brickwall.

Certifire Approval No CF 420

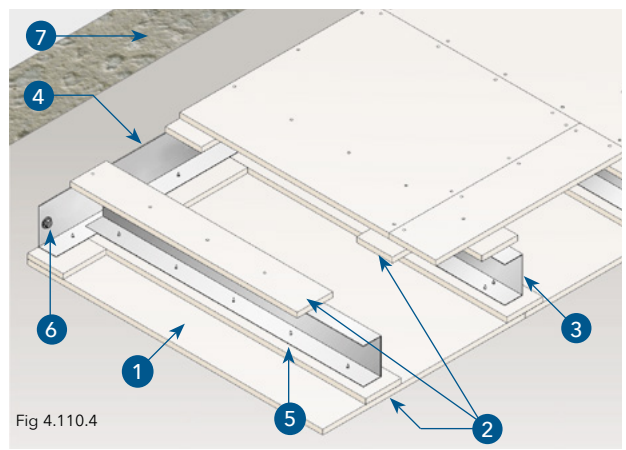
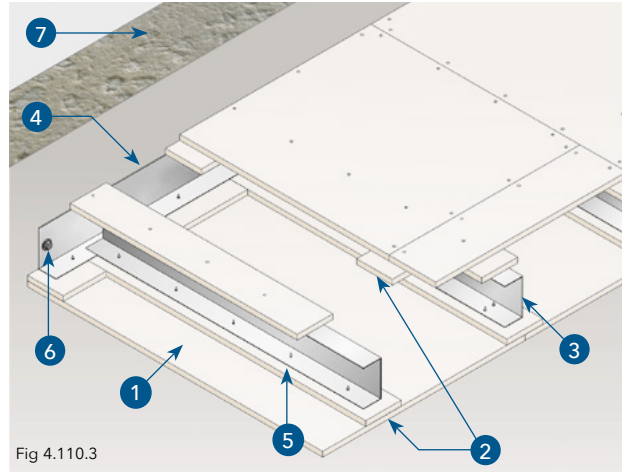

Ceiling span (m)	C Channel purlin (mm)	Perimeter angle thickness (mm)	Expansion gap at each end (mm)
1.2	76 x 34 x 0.55	1.0	8
1.4	92 x 34 x 0.55	1.0	8
1.6	92 x 34 x 0.75	1.0	12
1.8	100 x 44 x 1.0	2.0	12
2.0	100 x 44 x 1.0	2.0	12
2.2	100 x 44 x 1.0	2.0	15
2.4	100 x 44 x 1.2	2.0	15
2.6	100 x 44 x 1.6	2.0	15
2.8	100 x 44 x 1.9	2.0	18
3.0	150 x 44 x 1.2	2.0	18
3.2	150 x 44 x 1.2	3.0	18
3.4	150 x 44 x 1.6	3.0	23
3.6	150 x 44 x 1.6	3.0	23
3.8	150 x 44 x 1.9	3.0	23
4.0	150 x 44 x 1.9	3.0	23

Certifire Approval No CF 420

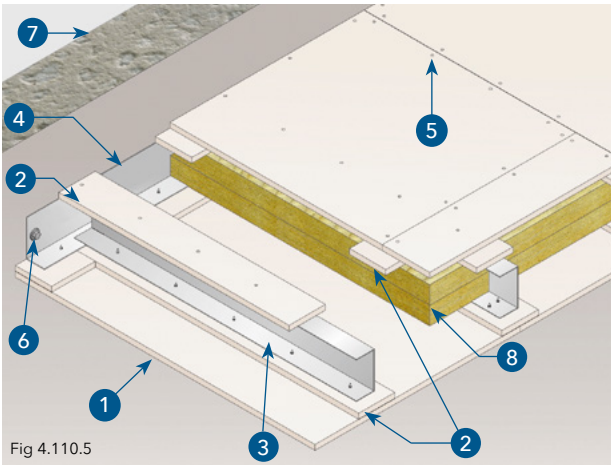

Fig 4.110.5

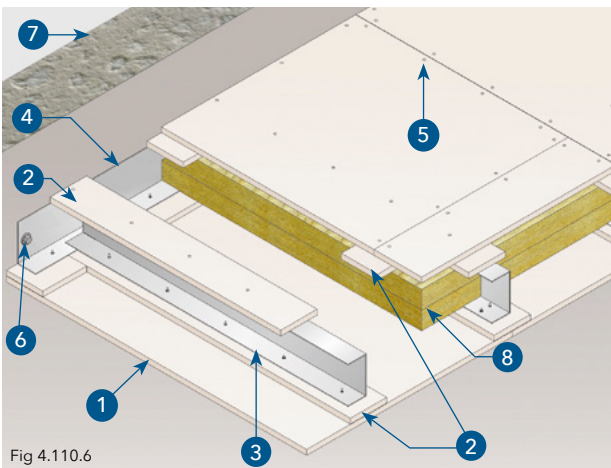

Fig 4.110.6

Table 4c 60 and 120 minutes

Ceiling span (m)	C Channel purlin (mm)	Perimeter angle thickness (mm)	Expansion gap at each end (mm)
1.2	76 x 34 x 0.55	1.0	8
1.4	92 x 34 x 0.55	1.0	8
1.6	92 x 34 x 0.75	1.0	12
1.8	100 x 44 x 1.0	2.0	12
2.0	100 x 44 x 1.0	2.0	12
2.2	100 x 44 x 1.0	2.0	15
2.4	100 x 44 x 1.2	2.0	15
2.6	100 x 44 x 1.6	2.0	15
2.8	100 x 44 x 1.9	2.0	18
3.0	150 x 44 x 1.2	2.0	18
3.2	150 x 44 x 1.2	3.0	18
3.4	150 x 44 x 1.6	3.0	23
3.6	150 x 44 x 1.6	3.0	23
3.8	150 x 44 x 1.9	3.0	23
4.0	150 x 44 x 1.9	3.0	23

SELF-SUPPORTING CEILING MEMBRANES

TECHNICAL DATA

60 minutes fire rating, integrity and insulation in accordance with the criteria of BS 476: Part 22: 1987 with fire from above or below.

1. Promat SUPALUX® boards, 9mm thick (square edged).
2. Promat SUPALUX® fillets, 75mm x 9mm thick The thickness of Promat SUPALUX® fillets on underside of the perimeter angles may be reduced by 3mm to maintain an even surface for the main ceiling boards. Lateral board joints backed by Promat SUPALUX® fillet fastened using M4 x 25mm long self-tapping screws at nominal 200mm centres on both sides of the joint.
3. C-channel purlins (see table below) positioned at maximum 610mm centres. Expansion gap is left at both ends of the C channels.
4. Perimeter steel angle, nominally 75mm x 50mm, fastened to wall around perimeter of ceiling, through the 50mm leg, with minimum M6 x 50mm long all steel fixing anchors at 300mm nominal centres. See table below for angle thickness.
5. M4 x 38mm long self-tapping screws fixed at 200mm centres on facing board and M4 x 25mm long self-tapping screws at 500mm centres on coverstrip to purlins.
6. M6 x 50mm long steel expansion bolts at 300mm centres.
7. Concrete or brickwall.
8. Rock wool, minimum 2 x 50mm x 45kg/m³ joints staggered by 300mm between layers.

120 minutes fire rating, integrity and insulation in accordance with the criteria of BS 476: Part 22: 1987 with fire from above or below.

1. Promat SUPALUX® boards, 12mm thick (square edged).
2. Promat SUPALUX® fillets, 75mm x 12mm thick. The thickness of Promat SUPALUX® fillets on underside of the perimeter angles may be reduced by 3mm to maintain an even surface for the main ceiling boards. Lateral board joints backed by Promat SUPALUX® fillet fastened using M4 x 25mm long self-tapping screws at nominal 200mm centres on both sides of the joint.
3. C-channel purlins (see table below) positioned at maximum 610mm centres. Expansion gap is left at both ends of the C channels.
4. Perimeter steel angle, nominally 75mm x 50mm, fastened to wall around perimeter of ceiling, through the 50mm leg, with minimum M6 x 50mm long all steel fixing anchors at 300mm nominal centres. See table for angle thickness.
5. M4 x 38mm long self-tapping screws fixed at 200mm centres on facing board and M4 x 25mm long self-tapping screws at 500mm centres on coverstrip to purlins.
6. M6 x 50mm long steel expansion bolts at 300mm centres.
7. Concrete or brickwall.
8. Rock wool, minimum 2 x 50mm x 80kg/m³ joints staggered by 300mm between layers.

Suspended Membrane Ceilings, Promat DURASTEEL®

PROMAT DURASTEEL®

DURASTEEL® ceilings provide fire protection for up to 240 minutes and can be built as insulated and uninsulated barriers.

TECHNICAL DATA

Fig 4.120.1

DURASTEEL® Suspended Membrane Ceiling
(E 240 - Integrity Only) Fire from above or below

Fire resistance	240 minutes integrity only
Channel (minimum)	80mm x 60mm x 3mm
Overall depth	89.5mm
Weight (nominal)	27kg/m ²

Certifire Approval No CF 429

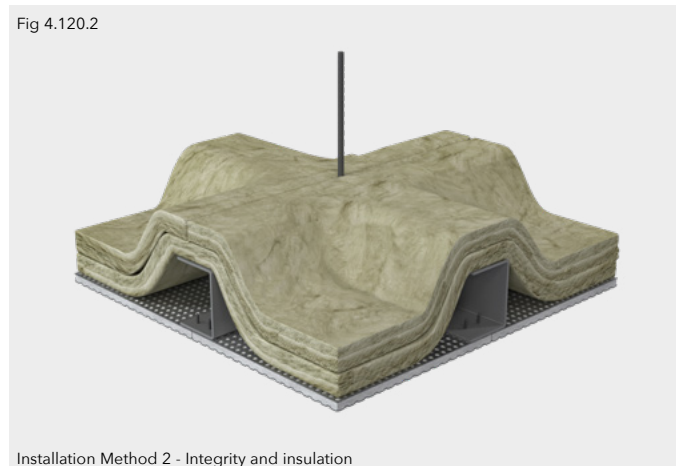
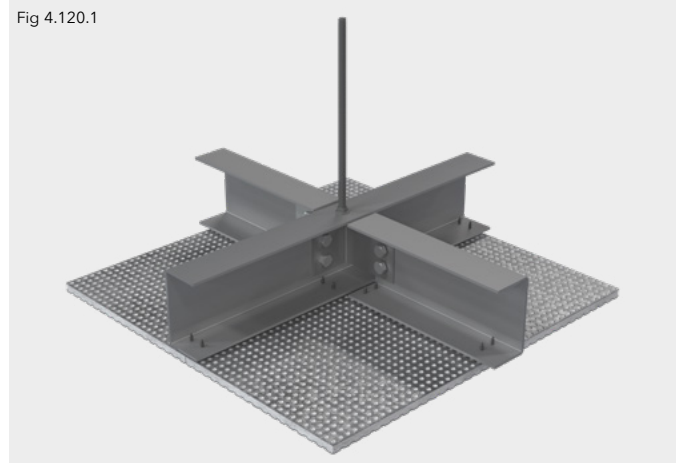

Fig 4.120.2

DURASTEEL® Suspended Membrane Ceiling
(E 240 - EI 60) Fire from above and below

Fire resistance	240 minutes integrity 60 minutes insulation
Channel (minimum)	80mm x 60mm x 3mm
Overall depth	140mm
Weight (nominal)	34kg/m ²

Installation Method 2 - Integrity and insulation

Note: For specific construction details please contact Promat Technical Services Department.

Certifire Approval No CF 429

Fig 4.120.3

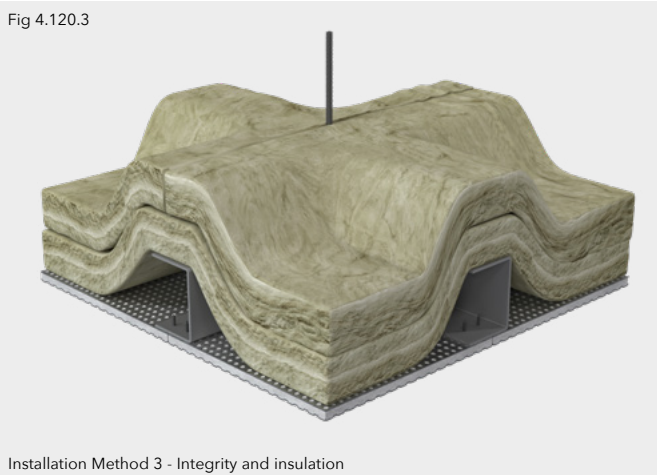

Installation Method 3 - Integrity and insulation

Fig 4.120.4

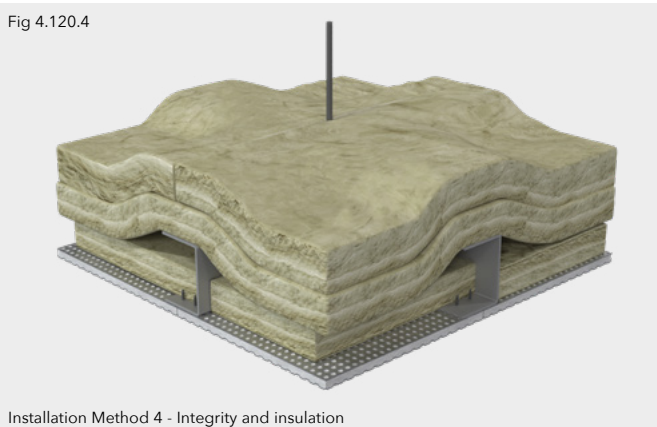

Installation Method 4 - Integrity and insulation

PROMAT DURASTEEL®

TECHNICAL DATA

Fig 4.120.3
DURASTEEL® Suspended Membrane Ceiling
(E 240 - EI 120) Fire from above and below

Fire resistance	40 minutes integrity 120 minutes insulation
Channel (minimum)	80mm x 60mm x 3mm
Overall depth	170mm
Weight (nominal)	39kg/m ²

Fig 4.120.4
DURASTEEL® Suspended Membrane Ceiling
(EI 240) Fire from above and below

Fire resistance	240 minutes integrity and insulation
Channel (minimum)	80mm x 60mm x 3mm
Overall depth	170mm
Weight (nominal)	45kg/m ²

=Note: For specific construction details please contact Promat Technical Services Department.

Self-supporting Ceilings, Promat DURASTEEL®

PROMAT DURASTEEL®

TECHNICAL DATA

Fig 4.120.5

DURASTEEL® Self-Supporting Ceiling Membrane
(E 240) Fire below only

Fire resistance	240 minutes integrity
Channel (minimum)	150mm x 60mm x 3mm back to back
Maximum span	4400mm
Overall depth	160mm
Weight (nominal)	27kg/m ²

Note: For specific construction details please contact Promat Technical Services Department.

Certifire Approval No CF 429

Fig 4.120.5

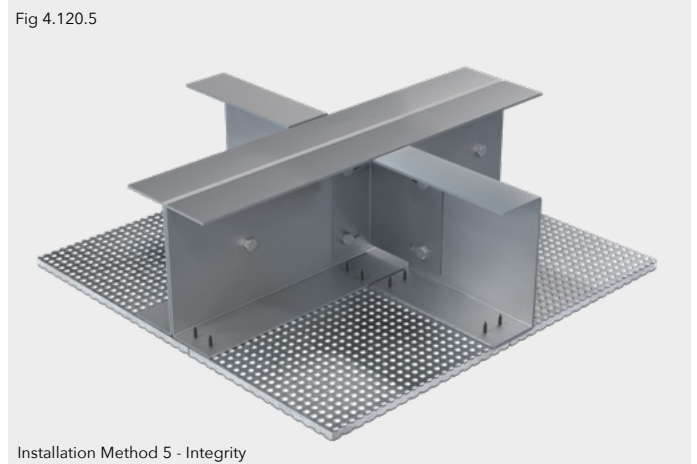

Promat SUPALUX® Protected Zones

FPA DESIGN GUIDE FOR THE FIRE PROTECTION OF BUILDINGS

The FPA Design Guide is a document aimed at protecting businesses against disruption and loss of critical stock and machinery due to fire. It is published by the Fire Protection Association, in association with the InFiReS fire research group.

In 2000, the LPC published the most recent edition of Design Guide for the Fire Protection of Buildings. This was a major work of reference for those most closely concerned with the design and construction of industrial and commercial buildings.

Now published by the FPA, the Design Guide informs architects and designers about the business risk management issues which relate to the fire protection of buildings, issues which supplement in very important ways the life safety requirements contained in the principal legislative controls (Approved Document B). Within the document, there is information on extent of the zone, fire ratings expected by insurers and the industry as a whole.

The FPA has subsequently published a number of separate guides covering specific topics including the Design Guide for the protection of buildings - Protected Zone (2004). This is available through the FPA website at <http://www.thefpa.co.uk>.

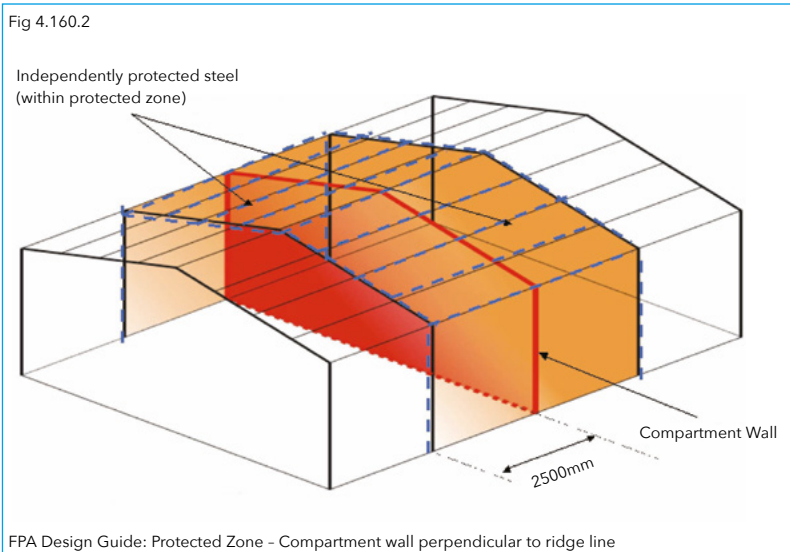
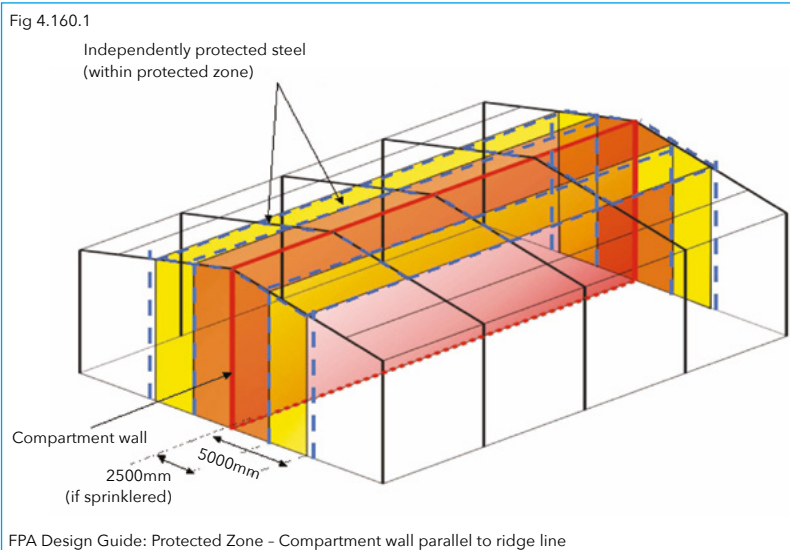

Promat SUPALUX® Protected Zones, E60, EI15

This control zone construction is only applicable to roof coverings that will not in themselves contribute to fire spread. For confirmation of this, consult with the roof manufacturer.

1. MF6 perimeter channel (1) 20 x 28 x 30mm x 0.5mm, fixed to surrounding construction at 500mm centres using non-combustible screws or plugs and anchors (depending on element of construction).
2. MF7 primary support channel (2) 15 x 45 x 0.9mm thick suspended from purlins at max. 610mm centres using 25mm x 0.55mm thick MF8 strap hangers (3). MF7 channels rested on top flange of MF6 perimeter channel at 600 centres.
3. MF8 strap hangers (3) fixed to purlins using 38mm Ejoy Tec screws. Hangers fixed to MF7 primary grid system (2) using 32mm drywall screws.
4. MF5 ceiling sections (4) 80 x 26 x 0.5mm at max. 610mm centres on underside of primary grid, connecting to MF7 channel using MF9 connecting clips (5) and engaging into MF6 perimeter channel.
5. 9mm Promat SUPALUX® ceiling (6) fixed to MF5 channel using 25mm drywall screws at 200mm centres.
6. 9mm Promat SUPALUX® 100mm wide cover strips (7) fixed at transverse joints using 32mm drywall screws at 200mm centres, fixed on both sides of the joint.
7. Rock wool insulation (8) 50mm thick x minimum 35kg/m³ laid over Promat SUPALUX® boards, insulation butted up to MF5 ceiling sections. The vertical rock wool (14) is retained in position using 1mm iron wire.
8. Vertical boards (1 layer of 9mm Promat SUPALUX®) (11), fixed to steel sections with 100mm wide cover strips at transverse joints. Boards cut to fit within purlin and fitted flush to underside of roof. Any gaps to be fire stopped with rock wool. Board fixed at base to angle fixed to MF5 section (10) and also at top to MF7 channel (12) spanning between, and fastened to the purlins. Maximum drop 600mm.

BFTC Report 0725

Fig 4.170.1

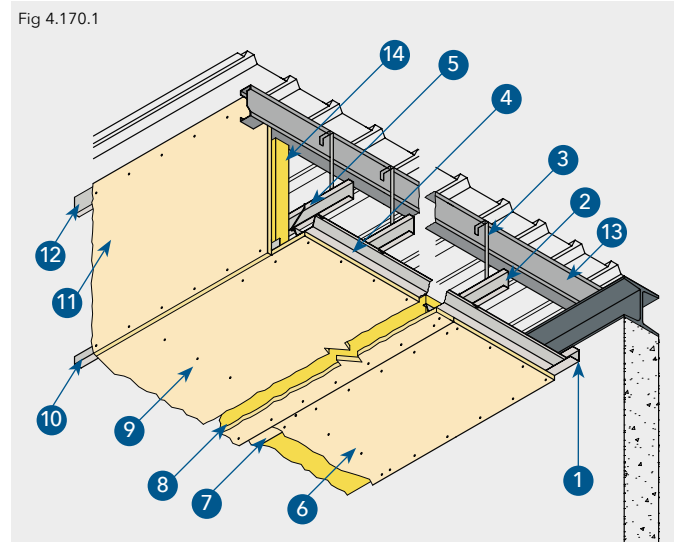

9. Purlins (13) at maximum 1.8m centres, supported by steel beam or on top of blockwork wall. Steel beams require boxing with minimum of 12mm Promat PROMATECT®-250 to provide required 60 minutes fire compartmentation and fire protection to the steel (omitted for clarity, contact Promat Technical Services for confirmation of board thickness required).
10. All gaps, abutments, air and smoke paths to be fire stopped, and sealed with Promat PROMASEAL® Sealant.

Promat SUPALUX® Protected Zones, E120, E115

BFTC Report 0721

This control zone construction is only applicable to roof coverings that will not in themselves contribute to fire spread. For confirmation of this, consult with the roof manufacturer.

1. MF6 perimeter channel (1) 20 x 28 x 30mm x 0.5mm, fixed to surrounding construction at 500mm centres using non-combustible screws or plugs and anchors (depending on element of construction).
2. MF7 primary support channel (2) 15 x 45 x 0.9mm thick suspended from purlins at max. 610mm centres using 25mm x 0.55mm thick MF8 strap hangers (3). MF7 channels rested on top flange of MF6 perimeter channel at 600 centres.
3. MF8 strap hangers (3) fixed to purlins using 38mm Ejoy Tec screws. Hangers fixed to MF7 primary grid system (2) using 32mm drywall screws.
4. MF5 ceiling sections (4) 80 x 26 x 0.5mm at max. 610mm centres on underside of primary grid, connecting to MF7 channel using MF9 connecting clips (5) and engaging into MF6 perimeter channel.
5. 9mm Promat SUPALUX® ceiling (6). First layer fixed to MF5 channel using 25mm drywall screws at 200mm centres.
6. 9mm Promat SUPALUX® ceiling (7). Second layer fixed to MF5 grid system using 36mm drywall screws at 200mm centres (8). Boards staggered by minimum 600mm centres. Second layer stitched to first layer at transverse joints (9) using 25mm drywall screws at 200mm centres.
7. Vertical boards (2 layers of 9mm Promat SUPALUX®) (10), fixed to steel sections with joints staggered by minimum 600mm, boards cut to fit within purlin and fitted flush to underside of roof. Any gaps to be fire stopped with rock wool. Boards fixed at base to angle fixed to MF5 section (11) and are also at top to MF7 channel (12) spanning between, and fixed to, the purlins. Maximum drop 600mm.

8. Purlins (13) at maximum 1.8m centres, supported by steel beam or on top of blockwork wall. Steel beams require boxing with minimum of 20mm Promat PROMATECT®-250 to provide required 120 minutes fire compartmentation and fire protection to the steel (omitted for clarity, contact Promat Technical Services for confirmation of board thickness required).
9. All gaps, abutments, air and smoke paths to be fire stopped, and sealed with Promat PROMASEAL® Sealant.

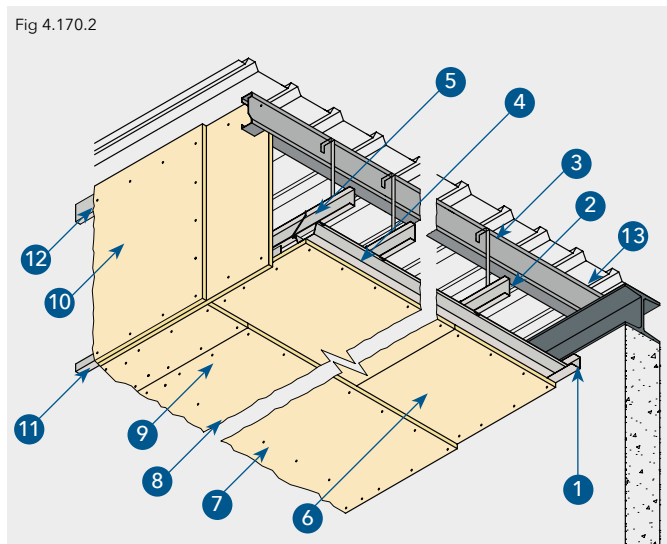

Promat SUPALUX® Protected Zones, E240, EI30

This control zone construction is only applicable to roof coverings that will not in themselves contribute to fire spread. For confirmation of this, consult with the roof manufacturer.

1. MF6 perimeter channel (1) 20 x 28 x 30mm x 0.5mm, fixed to surrounding construction at 500mm centres using non-combustible screws or plugs (depending on element of construction).
2. MF7 primary support channel (2) 15 x 45 x 0.9mm thick suspended from purlins at max. 610mm centres using 25mm x 0.55mm thick MF8 strap hangers (3). MF7 channels rested on top flange of MF6 perimeter channel at 600 centres.
3. MF8 strap hangers (3) fixed to purlins using 38mm Ejoy Tec screws. Hangers fixed to MF7 primary grid system (2) using 32mm drywall screws.
4. MF5 ceiling sections (4) 80 x 26 x 0.5mm at max. 610mm centres on underside of primary grid, connecting to MF7 channel using MF9 connecting clips (5) and engaging into MF6 perimeter channel.
5. 12mm Promat SUPALUX® ceiling (6). First layer fixed to MF5 channel using 25mm drywall screws at 200mm centres.
6. 12mm Promat SUPALUX® ceiling (7). Second layer fixed to MF5 grid system using 36mm drywall screws at 200mm centres (8). Boards staggered by minimum 600mm centres. Second layer stitched to first layer at transverse joints (9) using 25mm drywall at 200mm centres.
7. Vertical boards (2 layers of 12mm Promat SUPALUX®) (10), fixed to steel sections with joints staggered by minimum 600mm, boards cut to fit within purlin and fitted flush to underside of roof. Any gaps to be fire stopped with rock wool. Boards fixed at base to angle fixed to MF5 section (11) and are also at top to MF7 channel (12) spanning between, and fixed to, the purlins. Maximum drop 600mm.

BFTC Report 0724

Fig 4.170.3

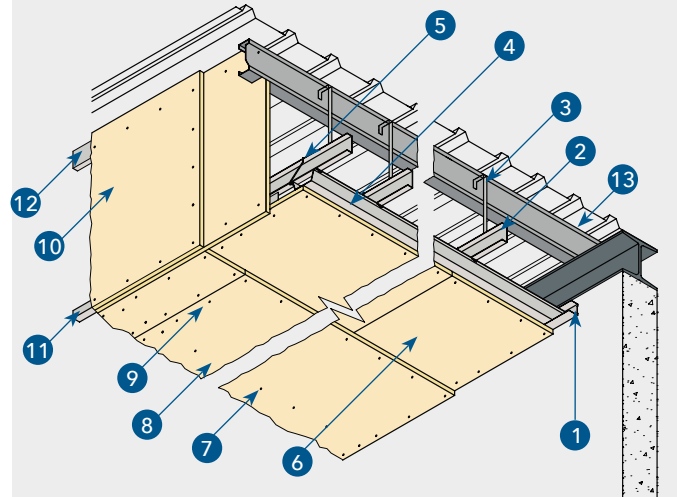

8. Purlins (13) at maximum 1.8m centres, supported by steel beam or on top of blockwork wall. Steel beams require boxing with minimum of 50mm Promat TD Board® to provide required 240 minutes fire compartmentation and fire protection to the steel (omitted for clarity contact Promat Technical Services for confirmation of board thickness required).
9. All gaps, abutments, air and smoke paths to be fire stopped, and sealed with Promat PROMASEAL® Sealant.

GB ORDERLINE

For placing orders, delivery enquiries
and local stockists etc.

T: 0800 373 636

F: 01275 379 037

E: sales.construction@promat.co.uk

TECHNICAL SERVICES

For technical support and advice.

T: 0800 145 6033

E: technical@promat.co.uk

RESOLUTIONS

For any problems with invoices or deliveries.

T: 01275 379 031 or 0800 373 636

E: customersupport@promat.co.uk

Etex Building Performance Limited

Marsh Lane, Easton-in-Gordano,
Bristol, BS20 0NE

T: 0800 373 636 F: 01275 379 037

promat.com

© 2023 Etex Building Performance Limited

V5(d) January 2023