

The Passive Fire Protection Handbook

The UK's comprehensive guide to passive fire protection

Chapter 1 Introduction

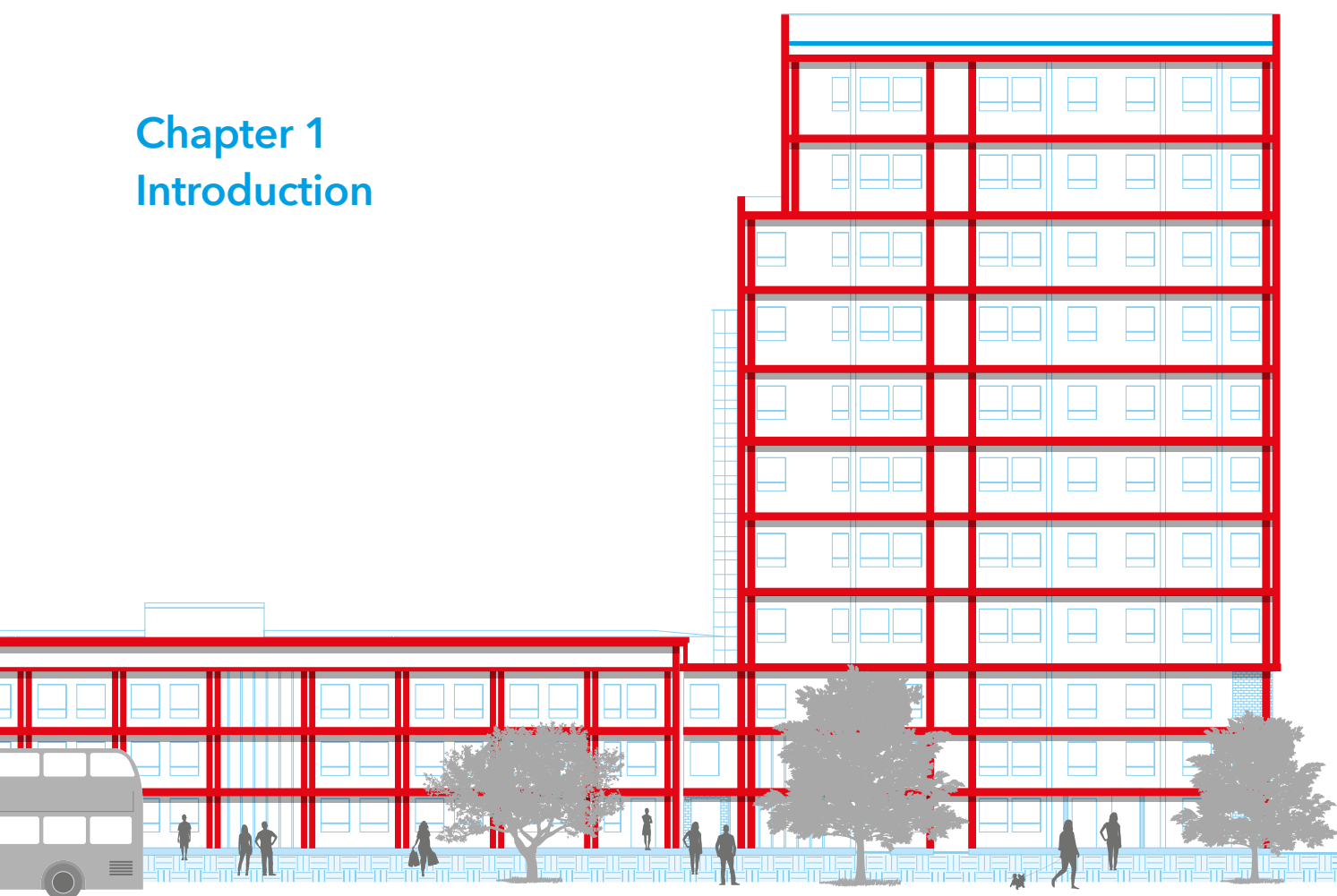

JUNE 2022



Contents

Chapter 1: Introduction	2
Applications Overview	2
Introduction	4
Principles of Fire Protection	6
Fire Testing.....	8

Introducing Etex Building Performance

Promat is part of Etex Building Performance, which combines the products and solutions of three prominent dry construction materials companies: Siniat, Promat and EOS Façades.

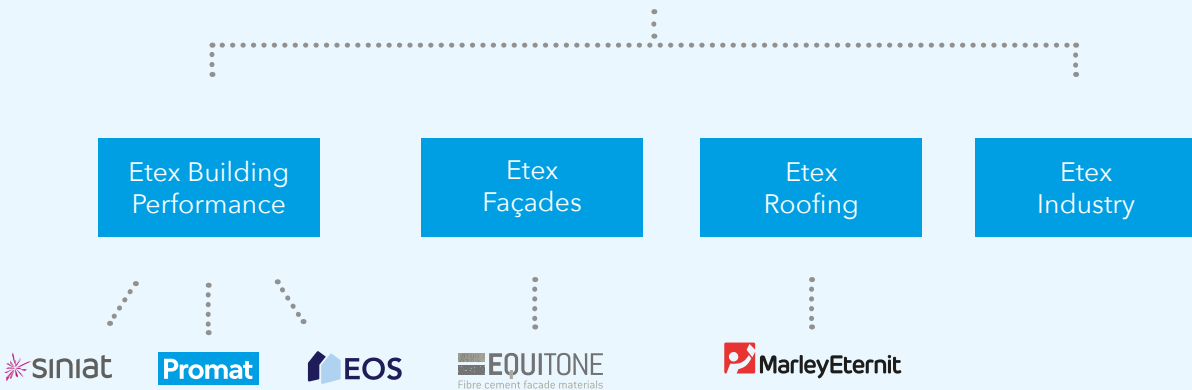

Siniat is a manufacturer of plasterboard and other drylining products. It makes systems for partitions, ceilings, wall linings and external sheathing purposes.



Promat is a specialist in passive fire protection and high performance insulation.



EOS Façades specialise in the design, manufacture, and supply of a wide range of steel solutions for the Steel Framing Systems (SFS) and off-site markets.



Chapter 1: Introduction

Applications Overview

SERVICE ENCLOSURES
CHAPTER 6

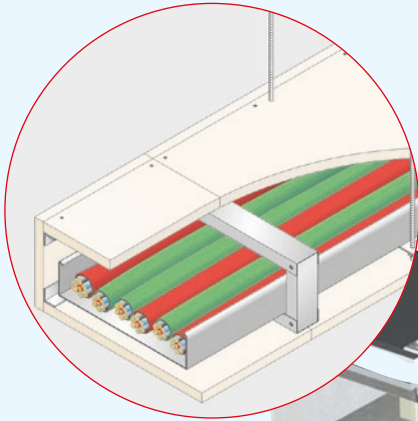

FIRE COMPARTMENT WALLS
CHAPTER 5

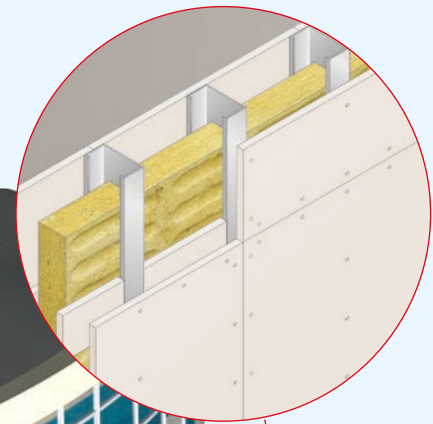

SMOKE EXTRACTION
PLENUMS
CHAPTER 4

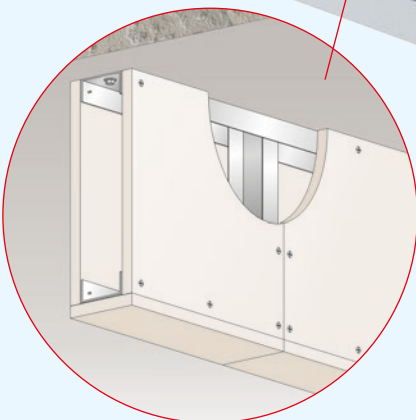
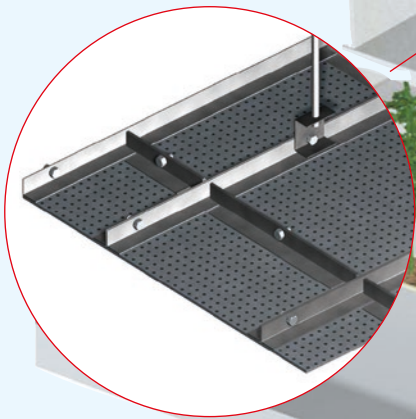

SMOKE BARRIER
CHAPTER 8

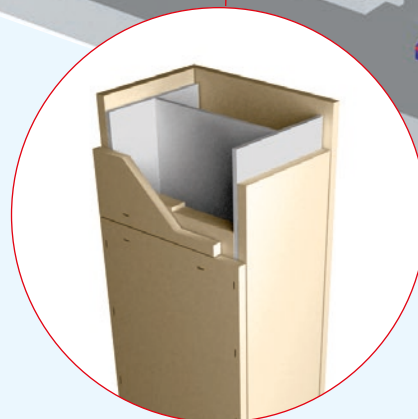

STEEL PROTECTION
CHAPTER 3

PENETRATION SEALS
CHAPTER 7

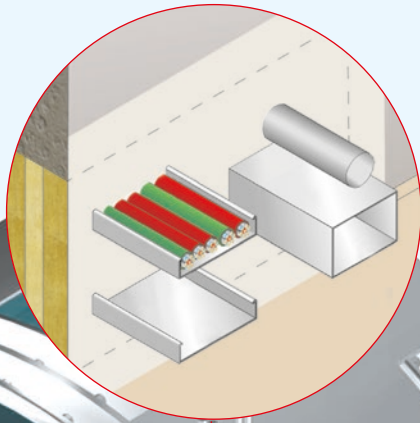

SMOKE EXTRACTION DUCTING
CHAPTER 6

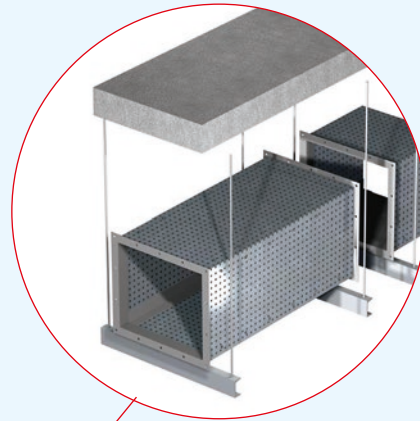

VENTILATION DUCTWORK
CHAPTER 6

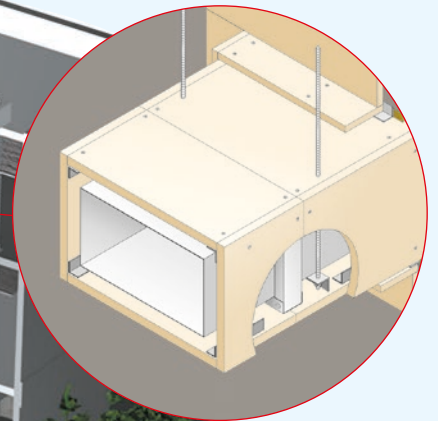

FIRE RESISTANT CEILINGS
CHAPTER 4

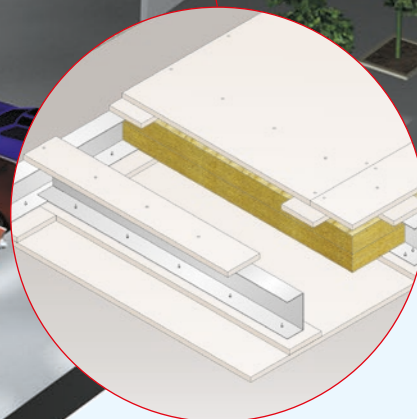

SERVICES

As the leading manufacturer of fire protection products and systems, Promat can supply solutions to the majority of PASSIVE FIRE PROTECTION requirements. Our know-how is available to you free of charge at any time, worldwide.

1. Advice from qualified specialists.
2. Project-related fire protection solutions.
3. Detailed drawings.
4. Comprehensive user back-up when applying for approval.
5. List of installation companies.
6. FIRAS approved installers.
7. Innovative fire protection technology, research and development.
8. Technical presentations to Architects, Building Control Officers, Fire Officers etc.
9. Safety based on over 40 years experience in the field of fire protection.

Chapter 1: Introduction

Introduction

This Promat organisation is part of the well known Worldwide group: Etex. Specialising in building materials, the Etex Group offers a support structure of knowledge, production and research and development.

FIRE SAFETY IN THE BUILDING INDUSTRY

A good building is a safe building, and an important factor is fire safety. Most countries have developed elaborate legislation regarding fire-safe construction, and one of the important tasks for Promat is its knowledge and understanding of the specific rules in each country and helping to close the gap between regulations and real life. Promat does this by providing a free advice service and helping parties within the building industry to make the right choices to realise true safety. Promat technical staff are engaged in a constant search for solutions. They are experts in fire safety legislation, follow any changes and test practical solutions. Support in materials, research and fire testing is given by Promat Research and Technology Centre (PRTC), based at the corporate headquarters in Belgium.

LEGISLATION AND INSURANCE

In fire, the tangible losses such as life and inventory are obvious and easy to quantify. However, intangible losses such as business interruption and financial instability are equally important. Insurers will look at the entire fire strategy when insuring a building, and will use a number of guidance and approved documents to assist them in this.

To provide guidance on life safety and escape, the Building Regulations 1991 are supported by a series of guidance documents, known as Approved Documents. Approved Document B 'Fire Safety' is split into two volumes. Volume 1 relates to Dwellinghouses, while Volume 2 relates to Buildings Other Than Dwellinghouses. This document covers fire safety in England and Wales.

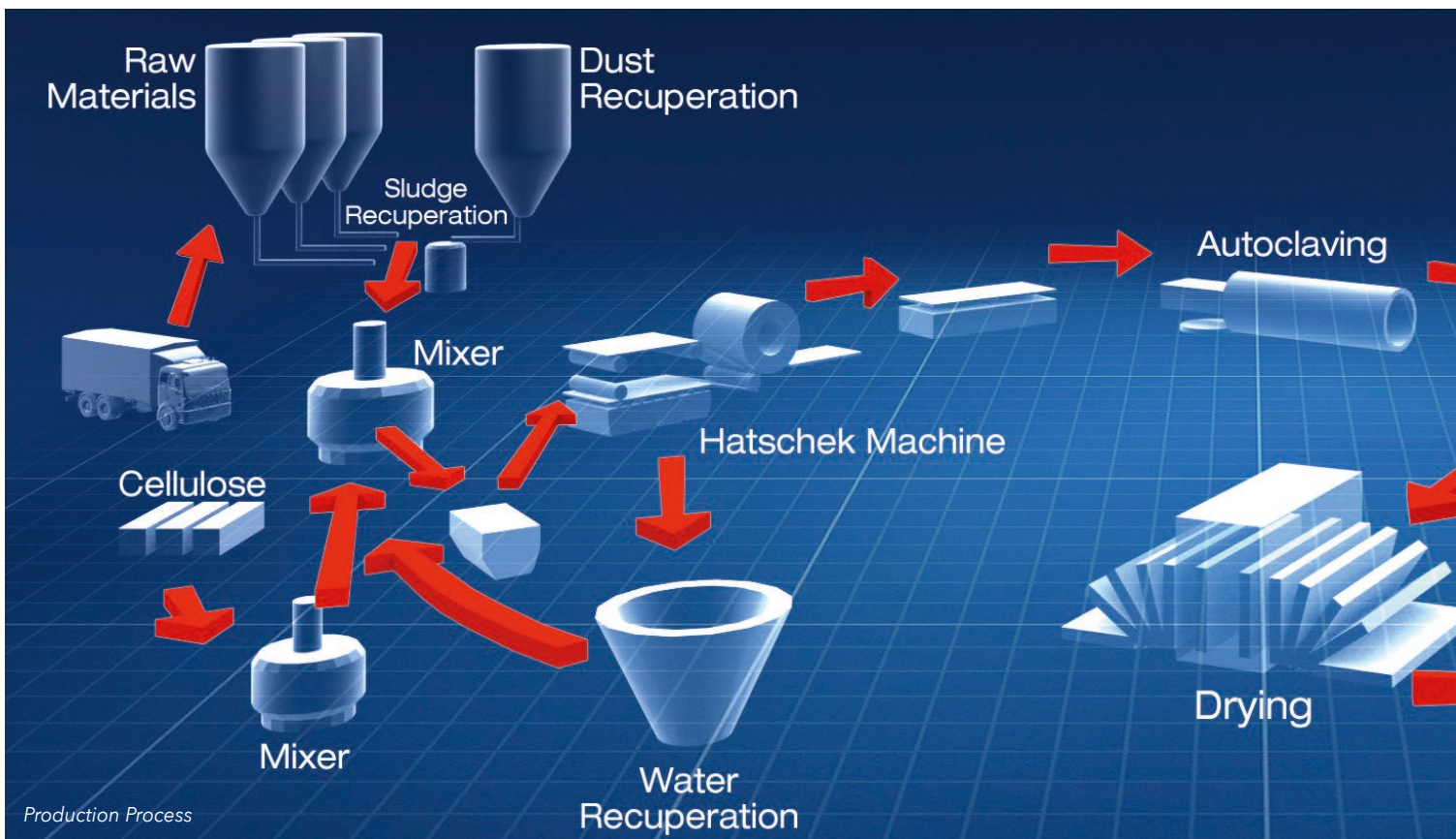

Chapter 1: Introduction

Legislation and Insurance (continued)

Scotland's requirements are set out in the Technical Standards Part D (structural fire precautions) and Part E (means of escape from fire and facilities for fire fighting). In contrast to Approved Document B, many of these provisions are mandatory and more time consuming, particularly those relating to fire resistance and non-combustible construction.

Northern Ireland follows England and Wales but also has a non-mandatory guide, Technical Booklet E 'Fire Safety' providing guidance on how to meet the Building Regulation requirements.

These regulations are given further support by the guidance laid down in the BS 5588 series, which breaks the construction of buildings down into individual building types. These standards are due to be replaced by DD 9999, however this document is still under review. Within these documents, reference is made to the ASFP fire protection guides. These guides are identified by colour and are shown in the panel on the right.

In addition to the "Colour Books" the ASFP produces a range of industry-leading guidance, including:

- Ensuring Best Practice for Passive Fire Protection in Buildings
- ASFP On-Site Guide to Installing Fire Stopping
- ASFP Guide to Inspecting Passive Fire Protection for Risk Assessors
- ASFP Technical Guidance Documents (TGD's)
- ASFP Advisory Notes

For protection of business and business continuity, additional guidance is recommended. The "FPA Design Guide for the Fire Protection of Buildings" and its supporting documents are aimed strictly at buildings other than dwellinghouses, and are written as a code of practice for the protection of business. Recommendations made in this guide are very often followed by insurers, looking for higher standards of protection than those laid down in Building Regulations.

The Association for Specialist Fire Protection (ASFP) is the leading industry body for the passive fire protection sector. Documentation produced by the association is seen as the industry standard, and is referenced in government legislation such as Approved Document B. The following guides are leading ASFP publications.

- Fire Protection for Structural Steel in Buildings (Yellow Book)
- Fire Resisting Ductwork (Blue Book)
- Fire Stopping and Penetration Seals for the Construction Industry (Red Book)
- Fire and Smoke Resisting Dampers (Grey Book)
- Fire Resisting Non-Loadbearing Partitions (Purple Book)

The above documents provide a detailed view of all relevant areas of construction.

The Regulatory Reform (Fire Safety) Order came into force on 1st October 2006 and brings together the many pieces of fire legislation under one document. It covers fire safety within all public premises, office and commercial buildings. The order puts the responsibility for fire safety on the building owner or occupier, or 'responsible person' and replaced the issue of Fire Certificates by the Fire and Rescue Service. A lack of adherence to the order can lead to prosecution and either a fine or penal sentence. This has been the biggest change in fire legislation in many years and has driven the need for quality, tested products to new levels.

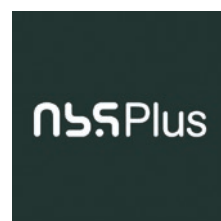
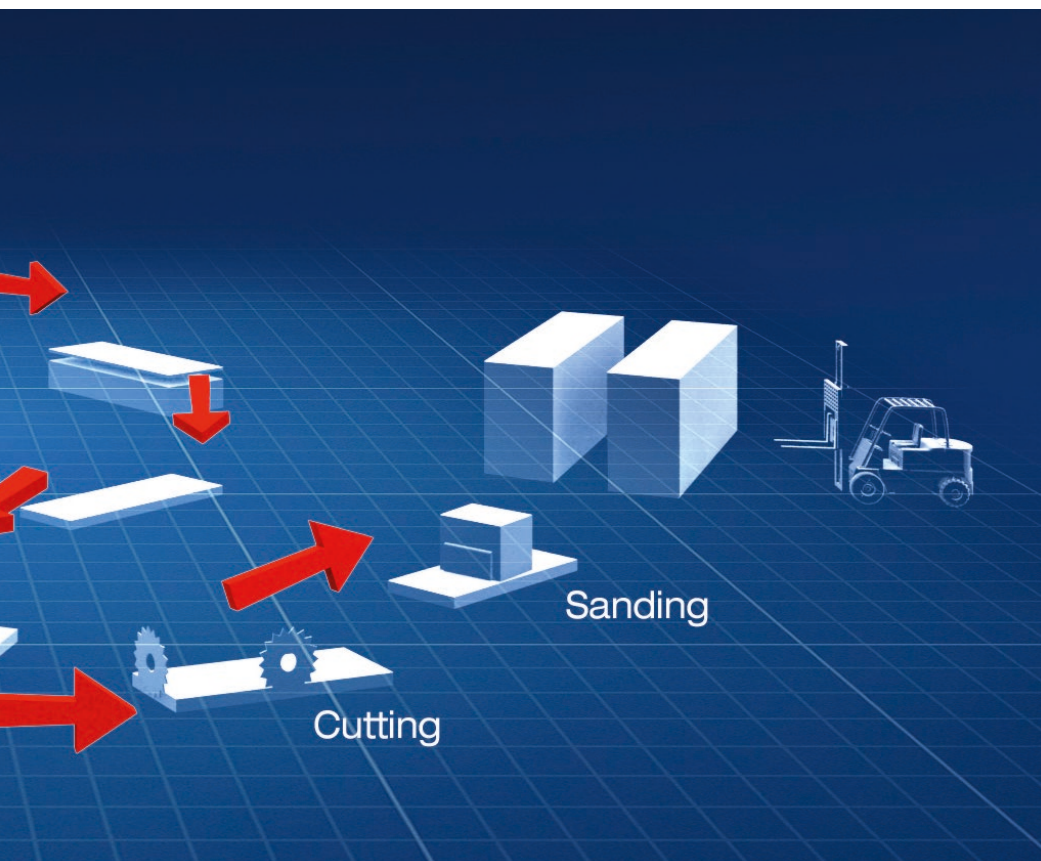

Principles of Fire Protection

WHAT IS PASSIVE FIRE PROTECTION?

Passive fire protection systems are built into the fabric of a building. They are always present, and do not require any external power or assistance to work. Passive Fire Protection products and systems are tested by independently approved testing authorities under standard test conditions. The fire performance standards and terms most relevant to the materials and elements of construction are described in this chapter.



In the UK, Promat endorses the use of third party product accreditation schemes such as CERTIFIRE and The Fire Accreditation Scheme (FIRAS) and believes that the credibility given by authorities like these gives the whole marketplace confidence in not only the product, but also the installation. Promat continue to push the development of fire protection systems further, constantly searching for improvement for the construction industry as a whole through representation at trade associations, BSI and CEN technical committees.

RESEARCH AND DEVELOPMENT

Fire rated constructions are seldom put to the test because not every building is subjected to a fire. During a fire, fire rated constructions allow people to reach safety, no one stops and measures the performance of the construction. So the only way to find out if Promat constructions work is to test them; and this is what Promat are doing continuously. Promat run fire investigation programmes at the Promat Research and Technology Centre (PRTC) facilities in Belgium. The Promat furnaces are state of the art and are used for testing of constructions while under development.

As well as British Standard and European EN testing, Promat are also at the forefront of development and certification with other international organisations, such as the Loss Prevention Certification Board (LPCB), Underwriters Laboratories (UL), Lloyds of London and Det Norske Veritas (DNV).

All Promat materials are manufactured in accordance with accredited BS EN ISO 9001 quality management systems. Comprehensive testing of all Promat products and systems has been carried out by independent and nationally approved laboratories around the world in order to meet the relevant sections of BS 476 and many other international test standards. Promat are actively working towards implementing the environmental standard EN ISO 14001 across all their manufacturing operations.

In conjunction with this technical manual and various other supporting documentation, such as technical recommendation sheets and Certifire approvals, our technical and sales support teams are available to provide information and assistance to help in the design and installation of all Promat fire protection solutions. As this document can only provide the basic construction details for most applications likely to be required on a project, it is inevitable there will be situations requiring more detailed information. In this event, please contact our Technical Services Department and one of our team will be pleased to assist you.

THE IMPORTANCE OF TESTING

Historically, each country in the European Union has developed its own fire tests in support of its national building regulations. In the UK, these methods are British Standards.

In the future, a common system of fire testing (reaction to fire and fire resistance) and classification of the resulting test data for construction products will be implemented across the EU member states.

During the transition period, both BS and EN references will be commonplace and are referenced in Approved Document B. The following section shows both BS and EN test methods.

Reaction to Fire (RtF) tests tell us how a product will become involved in the growth of fire in the room of origin, up to the time when flashover occurs, or does not occur. The data from specific small/intermediate reaction to fire test methods is assessed and provides a fire classification for the material.

Fire resistance tests tell us how an element of construction or fire protection system will prevent a fully developed fire from causing structural collapse of the element, or prevent the fire from passing from the room of origin into an adjacent room, corridor or other space.

The Importance of Testing (continued)

TEST ON MATERIALS

BS 476: Part 4: 1970 Non-combustibility test for materials

This test classifies materials as either ‘non-combustible’ or ‘combustible’. It is the most stringent standard for the fire performance of materials and gives a measure of the heat and flames generated by the material under standard heating conditions. Non-combustible materials can be used without restriction anywhere in a building. Their use ensures that hazards due to smoke and toxic gases are minimised and that the fabric of a building will not make a contribution to a fire.

BS 476: Part 6: 1989 Method of test for fire propagation for products

This test measures the amount and rate of heat evolved by the product while subjected to standard heating conditions. Test results are given as an Index of Performance (I) which is based on three sub-indices (i1, i2, i3). The higher the value of the Index, (I), the greater the material contribution to fire growth. The higher the value of the sub-index, i1 the greater the ease of ignition and flame spread.

BS 476: Part 7: 1987 Method for classification of the surface spread of flame for products.

This test classifies materials into Classes 1 to 4 in descending order of performance according to the rate and extent of flame spread over their surface under standard heating conditions. All Promat board products have the highest rating of surface spread of flame, i.e. Class 1.

BS 476: Part 11: 1982 Method of assessing the heat emissions from building materials

This standard describes a method for assessing the heat emissions from building materials when inserted into a furnace at a temperature of 750°C. It is similar to BS 476: Part 4: 1970 but differs in that Part 4 classifies the material as “combustible” or “non-combustible” whereas Part 11 criteria are specified in Approved Document B, leading to classification as a material of limited combustibility.

Class 0 (As defined in Approved Document B)

- a) Composed throughout of materials of limited combustibility, or
- b) A Class 1 (to BS 476: Part 7: 1987) material which has a fire propagation index (I) of not more than 12, and a sub-index (i1) of not more than 6 (to BS 476: Part 6: 1989).



Class	Test method	
A1	BS EN ISO 1182 and BS EN ISO 1716	Non-combustibility test (BS EN ISO 1182) This test identifies products that will not contribute significantly to a fire, regardless of their end use
A2	BS EN ISO 1182 or BS EN ISO 1716 and BS EN 13823	The test is relevant for the classes A1, A2.
B	BS EN 13823 and BS EN ISO 11925-2 exposure = 30s	Calorific potential test (BS EN ISO 1716) This test determines the potential maximum total heat release by a product when complete combustion occurs, regardless of its end use. The test is relevant for the classes A1, A2.
C	BS EN 13823 and BS EN ISO 11925-2 exposure = 30s	Single burning item test (BS EN 13823) “SBI test” This test evaluates the potential contribution of a product to the development of a fire in terms of heat and smoke release and burning droplets, under a fire situation simulating a single burning item in the corner of a room near to that product.
D	BS EN 13823 and BS EN ISO 11925-2 exposure = 30s	The test is relevant for the classes A2, B, C and D.
E	BS EN ISO 11925-2 exposure = 15s	Ignitability (BS EN ISO 11925-2) This test evaluates the ignitability of a product in a vertical orientation when exposed to a small flame on the surface and, where appropriate, the edge. The test is relevant for the classes B, C, D, E.
F	Not tested	

Fire Testing

As well as controlling the exposure temperature, the test standards require that the air pressure within the test furnace is maintained at a positive level in an attempt to create a worse case scenario and force hot gases and flame through the specimen under test. Thermocouples are fixed to the unexposed face of the specimen to measure the insulation against heat provided by the construction.



FIRE TESTING METHODS

The fire performance of any system will vary depending on the heating conditions to which it is exposed. National and international fire curves have been developed for differing fire exposures. Examples of fire curves carried out in test furnaces by recognised national organisations are as follows:

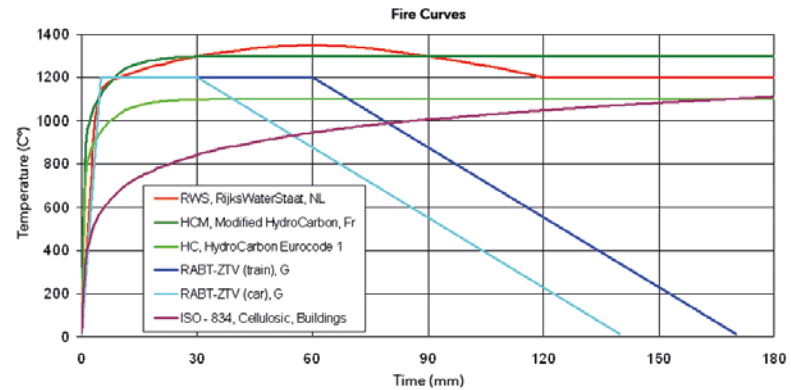

1. The Standard Cellulosic Time-Temperature Curve (ISO 834)

This ISO-based curve is used in standards throughout the world, including BS 476, AS 1530, DIN 4102, ASTM and the new European Norm (BS EN 1363-1). It is a model of a ventilated controlled natural fire, i.e. fires in a normal building. The temperature increase after 30 minutes is 842°C.

2. The Hydrocarbon Curve

This curve is a simulation of a ventilated oil fire with a temperature increase of 1110°C after 30 minutes. The Hydrocarbon Curve is applicable where petroleum fires might occur, i.e. petrol or oil tanks, certain chemical types etc. In fact, although the Hydrocarbon Curve is based on a standardised type fire, there are numerous types of fire associated with petrochemical fuels, which have wide variations in the duration of the fire, ranging from seconds to days.

3. The RABT Curve

This curve was developed in Germany as a result of a series of test programmes such as the Eureka project. In the RABT Curve (car), the temperature rise is very rapid up to 1200°C within 5 minutes. The duration of the 1200°C exposure is shorter than other curves with the temperature drop off starting to occur at 60 minutes. The curve relating to trains is also shown.

4. The RWS Curve (Rijkswaterstaat), NL

This model of a petroleum based fire of 300MW fire load in an enclosed area such as a tunnel, has been developed in the Netherlands and is specified for use in tunnels. It is internationally accepted. The temperature increase after 30 minutes is 1300°C.

Fire Testing

FIRE TESTING PERFORMANCE

Fire resistance is not a property of an individual material but is the measure of the performance of a complete system or construction when exposed to standard heating conditions.

The failure criteria of elements of building construction when tested in accordance with BS 476: Parts 20-24 are as follows:

Loadbearing Capacity (R)

The ability of a specimen of a loadbearing element to support its test load, where appropriate, without exceeding specified criteria with respect to either the extent of, or rate of deformation, or both.

Integrity (E)

The ability of a specimen of a separating element to contain a fire to specified criteria for collapse, freedom from holes, cracks and fissures and sustained flaming on the unexposed face.

Insulation (I)

The ability of a specimen of a separating element to restrict the temperature rise of the unexposed face to below specified levels (usually 140°C mean rise, 180°C maximum rise).

Stability

The ability of a ductwork system to maintain its intended function.

The above references (R, E and I) are commonly used within the fire protection industry when referring to BS 476 methods, however, they are actually European EN terms, as opposed to British Standard terms.

FIRE TESTING STANDARDS

The fire performance standards most commonly referred to are the British Standards (BS 476: Parts 20 to 24). The European Norms that follow are replacing BS 476 gradually and the current equivalents, where relevant, are as given below:

BS 476: Part 20: 1987
Methods for determination of the fire resistance of elements of construction (general principles).
 This part describes the general procedures and equipment required to determine the fire resistance of elements of construction. It should be read in conjunction with BS 476: Parts 21-24 as appropriate, which describe the detailed procedure for the testing of individual elements of construction.

EN Standards
EN 1363 -1 Fire Resistance Tests - General Requirements
 This part of EN 1363 establishes the general principles for determining the fire resistance of various elements of construction when subjected to standard fire exposure conditions. Alternative and additional procedures to meet special requirements are given in EN 1363-2.
EN 1363 - 2 Fire Resistance Tests - Alternative and Additional Procedures
 This part of EN 1363 specifies alternative heating conditions and other procedures that may need to be adopted under special circumstances. This standard shall be read in conjunction with EN 1363-1.
 Details of the alternative hydrocarbon, slow heating and external fire exposure heating curves and the additional impact test and measurement of radiation procedures are included within this standard. Within the appropriate clause for each procedure is given an explanation as to why it may be necessary.
 Unless one of the alternative heating regimes is specifically required, the standard temperature-time curve given in EN 1363-1 shall be used.

FIRE RESISTANCE TEST DOCUMENTS	
Test Standard	Application
GENERAL	
BS EN 1363 - 1	Fire resistance tests, general requirements
BS EN 1363 - 2	Fire resistance tests alternative and additional procedures
BS EN 1363 - 3	Verification of furnace performance
NON LOAD-BEARING ELEMENTS	
BS EN 1364 - 1	Walls
BS EN 1364 - 2	Ceilings
BS EN 1364 - 3	Curtain walls - full configuration
BS EN 1364 - 4	Curtain walls - part configuration
prEN 1364 - 5	Semi-natural fire test for facades and curtain walls
prEN 1364 - 6 is now an External wall systems	Cavity barriers
LOAD BEARING ELEMENTS	
BS EN 1365 - 1	Walls
BS EN 1365 - 2	Floors and Roofs
BS EN 1365 - 3	Beams
BS EN 1365 - 4	Columns
BS EN 1365 - 5	Balconies and walkways
BS EN 1365 - 6	Stairs
SERVICE INSTALLATIONS	
BS EN 1366 - 1	Ventilation ducts
BS EN 1366 - 2	Fire dampers
EN 1366 - 3	Penetration seals
EN 1366 - 4	Linear joint seals
EN 1366 - 5	Service ducts and shafts
BS EN 1366 - 6	Raised floors and hollow core floors
BS EN 1366 - 7	Conveyor systems and their closures
BS EN 1366 - 8	Smoke extraction ducts
BS EN 1366 - 9	Single compartment smoke extraction ducts
BS EN 1366 - 10	Smoke control dampers
BS EN 1366 - 11	Cable systems and associated components
BS EN 1366 - 12	Ventillation ductwork
BS EN 1366 - 13	Chimneys
FIRE DOOR AND SHUTTER ASSEMBLIES	
BS EN 1634 - 1	Doors and shutter assemblies
BS EN 1634 - 2	Elements of building hardware
BS EN 1634 - 3	Smoke control
CONTRIBUTION TO FIRE RESISTANCE OF STRUCTURAL MEMBERS	
BS EN 13381 - 1	Membrane protection - horizontal
BS EN 13381 - 2	Membrane protection - vertical
BS EN 13381 - 3	Concrete members
BS EN 13381 - 4	Applied passive protection to steel members
BS EN 13381 - 5	Concrete/profiled sheet composite elements
BS EN 13381 - 6	Concrete filled hollow steel columns
BS DD ENV 13381 - 7	Timber elements
BS EN 13381 - 8	Applied reactive protection to steel members
BS EN 13381 - 9	Steel beams with web openings
BS EN 13381 - 10	Solid steel bar in tension

Chapter 1: Introduction

Fire Testing

BS 476: Part 21: 1987

Methods for Determination of the Fire Resistance of Loadbearing Elements of Construction

This standard describes methods for determining the fire resistance of loadbearing beams, columns, floors, flat roofs and walls. Beams and columns are assessed in terms of loadbearing capacity, whilst dividing elements such as floors, flat roofs and walls are measured in terms of loadbearing capacity, integrity and insulation.

BS EN 1365 Fire Resistance Tests for Loadbearing Elements

Part 1. Walls

The part of EN1365 specifies a method of testing the fire resistance of loadbearing walls. It is applicable to both internal and external walls. The fire resistance of external walls can be determined under internal or external exposure conditions.

The fire resistance performance of loadbearing walls is normally evaluated without perforations such as glazing. If it can be demonstrated that the design of the opening is such that load is not transmitted to the perforation, then the perforation need not be tested in the loaded condition.

If perforations are to be included, the effects of these will need to be separately established. The performance of fire resistant glazing is addressed in EN 1364-1.

This test method is not applicable to:

- i) curtain walls (non-loadbearing external walls suspended in front of the floor slab) which are considered specifically in prEN 1364-3
- ii) walls containing door assemblies which shall be tested to EN 1634-1
- iii) non-separating load bearing walls which, in short widths, can be tested as columns to EN 1365-4

This European Standard is used in conjunction with EN 1363-1

Part 2. Floor and Roofs

This part of EN 1365 specifies a method for determining the fire resistance of:

- floor constructions, without cavities or with unventilated cavities
- roof constructions, with or without cavities (ventilated or unventilated)
- floor and roof constructions incorporating a glazed element; with fire exposure from the underside

This standard is used in conjunction with EN 1363-1

Part 3. Beams

This part of EN 1365 specifies a method for determining the fire resistance of beams with or without applied fire protection systems and with or without cavities. This standard is used in conjunction with EN 1363-1.

Beams which are part of a floor construction are tested with the floor construction as described in EN 1365-2 and are subject to evaluation of integrity and insulation.

Part 4. Columns

This part of EN 1365 specifies a method for determining the fire resistance of columns when fully exposed to fire on all sides. This Standard is used in conjunction with EN 1363-1.

Part 5. Balconies and Walkways

This part of EN 1365 specifies a method of determining the fire resistance, in respect of loadbearing capacity and with no separating function of:

- balconies exposed to the fire from either outside or inside the building; and
- walkways exposed to the fire from either outside or inside the building

This standard is used in conjunction with EN 1363-1

Part 6. Stairs

This part of EN 1365 specifies a method for determining the fire resistance of stairs, with or without applied fire protection systems in respect of loadbearing capacity and with no separating function. This document is used in conjunction with EN 1363-1.

BS 476: Part 22: 1987

Methods for Determination of the Fire Resistance of Non-Loadbearing Elements of Construction

This standard describes methods for determining the fire resistance of non-loadbearing partitions, doorsets, shutter assemblies, ceiling membranes and glazed elements of construction with respect to integrity, and where appropriate, insulation.

BS EN 1364 Fire Resistance Tests for Non-Loadbearing Elements

Part 1. Walls

This part of EN 1364 specifies a method of determining the fire resistance of non-loadbearing walls.

This Standard is used in conjunction with EN 1363-1

It is applicable to internal non-loadbearing walls with and without glazing, non-loadbearing walls consisting almost wholly of glazing, (glazed non-loadbearing walls) and other non-loadbearing internal and external non-loadbearing walls with and without glazing.

The fire resistance of external non-loadbearing walls can be determined under internal or external exposure conditions. In the latter case the external fire exposure curve given in EN 1363-2 is used.

It is not applicable to:

- i) curtain walls (external non-loadbearing walls suspended in front of the floor slab) which are considered specifically in prEN 1364-3.
- ii) non-loadbearing walls containing door assemblies which shall be tested to EN 1634-1.

Part 2. Ceilings

This part of EN 1364 specifies a method of determining the fire resistance of ceilings, which in themselves possess fire resistance independent of any building element above them. This standard is used in conjunction with EN 1363-1.

The method is applicable to ceilings, which are either suspended by hangers or fixed directly to a supporting frame of construction, and to self-supporting ceilings.

Within this test method, the ceiling is exposed to fire, with the exposure being applied either:

- a) from below the ceiling, or
- b) from above the ceiling to simulate fire within the cavity above the ceiling

BS EN 1634 Fire Resistance Tests for Door and Shutter Assemblies

Part 1. Fire Doors and Shutters

This part of EN 1634 specifies a method for determining the fire resistance of door and shutter assemblies designed for installation within openings incorporated in vertical separating elements, such as:

- hinged and pivoted doors;
- horizontally sliding and vertically sliding doors including articulated sliding doors, sectional doors;
- steel single skin folding shutters (uninsulated);
- other sliding folding doors;
- tilting doors;
- rolling shutter doors.

This European Standard is used in conjunction with EN 1363-1

Part 3. Smoke Control Test for Door and Shutter Assemblies

This part of EN 1634 specifies a method for determining the leakage of cold and warm smoke from one side of a door assembly to the other under the specified test conditions. The test can be applied to door and shutter assemblies of different types intended for purposes of controlling the passage of smoke in case of fire. This test can also be applied to lift landing doors and conveyor system doors and shutters.

Chapter 1: Introduction

Fire Testing

BS 476: Part 23: 1987 Methods for Determination of the Contribution of Components to the Fire Resistance of a Structure

This standard describes test methods for:

- a) determination of the contribution of suspended ceilings to the fire resistance of steel beams; and
- b) determination of the contribution of intumescent seals to the fire resistance of timber door assemblies.

BS 476: Part 24: 1987 Methods for Determination of the Fire Resistance of Ventilation Ducts

This standard describes the methods used to test and measure the ability of a duct assembly to prevent the spread of fire from one fire compartment to another. Results are expressed in terms of stability, integrity and insulation.

BS EN 1366 Fire Resistance Tests for Service Installations

Part 1. Ducts

This part of EN 1366 specifies a method for determining the fire resistance of vertical and horizontal ventilation ducts under standardised fire conditions. The test examines the behaviour of ducts exposed to fire from the outside (duct A) and fire inside the duct (duct B). This Standard is used in conjunction with EN 1363-1.

Part 2. Fire Dampers

This part of EN 1366 specifies a method for determining the fire resistance of fire dampers installed in fire separating elements designed to withstand heat and the passage of smoke and gases at high temperature. The standard is used in conjunction with EN 1363-1.

The method is primarily intended for tests of mechanical devices. It is not suitable for testing fire dampers in suspended ceilings without modification.

Part 5. Service Ducts and Shafts

This part of EN 1366 specifies a method for determining the fire resistance of horizontal service ducts and vertical service shafts, which pass through walls or floors and enclose pipes and cables. The test examines the behaviour of ducts and shafts exposed to fire from outside and from inside the duct. This standard is used in conjunction with EN 1363-1.

This standard does not examine the risk of fire spread as a result of thermal conduction along the piping installed in service ducts or shafts, or thermal conduction through the media these pipes carry. It does not cover the risk of damage produced by thermal elongation or shortening as a result of fire, or damaged pipe suspensions. The standard does not give guidance on how to test one, two or three sided service ducts or shafts.

This test is unsuitable for evaluating service ducts with internal barriers at walls and floors.

Whilst the walls of service ducts or shafts tested to this method may provide specified levels of integrity or insulation, testing to this standard does not replace the testing of the functional endurance of small electrical cables which is covered in EN 50200.

Fire resistance testing of ducts for air distribution systems is covered in EN 1366-1.

Part 8. Smoke Extract Ducts

This part of EN 1366 specifies a test method for determining the fire resistance of smoke extraction ducts. It is applicable only to smoke extraction ducts that pass through another fire compartment from the fire compartment to be extracted in case of fire. It represents fire exposure of a fully developed fire.

This method of test is only applicable to fire resisting ducts that have passed the test for the appropriate period to EN 1366-1 (ducts A and B). For duct A, it is a requirement for fire resisting smoke extraction ducts that the test pressure of 300 Pa, as given in EN 1366-1 is increased to 500 Pa when testing to EN 1366-1. For the purposes of the test described in this document, the duct is referred to as duct C.

This test has been designed to cover both vertical and horizontal smoke extraction ducts. However, provided both horizontal and vertical tests have been carried out to EN 1366-1 on the specific system, a vertical system need not be evaluated to this method provided it has been tested in a horizontal orientation to this method. However, if the system in practice is only to be used for vertical applications in smoke extraction systems, then it will need to be tested in a vertical orientation to this method.

This method of test is only suitable for ducts constructed from non-combustible materials (Euroclass A1 and A2). It is applicable only to four sided ducts; one, two and three sided ducts are not covered.

BS EN 1366 Fire Resistance Tests for Service Installations

Part 3. Penetration Seals

This document specifies a method of test and criteria for the evaluation of the ability of a penetration sealing system to maintain the fire resistance of a separating element at the position at which it has been penetrated by a service. Excluded are chimneys, air ventilation systems, fire rated ventilation ducts, fire rated service ducts, shafts and smoke extraction ducts.

Supporting constructions are used in this document to represent separating elements such as walls or floors. These simulate the interaction between the test specimen and the separating element into which the sealing system is to be installed in practice.

This document is used in conjunction with EN 1363-1.

The purpose of this test described in this document is to assess:

- a) the effect of such penetrations on the integrity and insulation performance of the separating element concerned;
- b) the integrity and insulation performance of the penetration sealing system;
- c) the insulation performance of the penetrating service or services and, where necessary, the integrity failure of a service.

No information can be implied by the test concerning the influence of the inclusion of such penetrations and sealing systems on the load-bearing capacity of the separating element.

It is not the intention of this test to provide quantitative information on the rate of leakage of smoke and/or hot gases or on the transmission or generation of fumes. Such phenomena should only be noted in describing the general behaviour of test specimens during the test.

This test does not supply any information on the ability of the penetration sealing system to withstand stress caused by movements or displacements of the penetration services.

Part 4. Linear Joint Seals

This European Standard specifies a method for determining the fire resistance of linear joint seals based on their intended end use.

This European Standard is used in conjunction with EN 1363-1.

The following tests are included in this European Standard:

- no mechanically induced movement
- mechanically induced movement, either prior to or during fire exposure

This European Standard does not provide quantitative information on the rate of leakage of smoke and/or hot gases, or on the transmission or generation of fumes. The loadbearing capacity of a linear joint seal is not addressed in this European Standard.

GB ORDERLINE

For placing orders, delivery enquiries
and local stockists etc.

T: 0800 373 636

F: 01275 379 037

E: orderline@etexbp.co.uk

TECHNICAL SERVICES

For technical support and advice.

T: 0800 145 6033

E: technical.promat@etexbp.co.uk

RESOLUTIONS

For any problems with invoices or deliveries.

T: 01275 379 031 or 0800 373 636

E: customer.support@etexbp.co.uk

Etex Building Performance Limited

Marsh Lane, Easton-in-Gordano,

Bristol, BS20 0NE

T: 0800 373 636 F: 01275 379 037

promat.com

© 2022 Etex Building Performance Limited

V4 14/06/2022